

SAUTER GmbH – member of the KERN & SOHN Group, the assortment wide champion at the foot of the Swabian Alb

Sauter GmbH
c/o KERN & SOHN GmbH
Ziegelei 1
72336 Balingen
Germany
Tel. +49 7433 9933-0
info@sauter.eu



Printed in Germany by SAUTER GmbH - z-es-en-kp-20231

MEASURING TECHNOLOGY & TEST SERVICE for industry, laboratory and quality assurance

Discover the vast world of scales and measuring technology from KERN online: www.sauter.eu

Follow us also on our social media channels



2023

EN



PROFESSIONAL MEASURING



MEASURING TECHNOLOGY & TEST SERVICE

for industry, laboratory and quality assurance

Keyword index

Coating thickness gauge, digital	52-56
Force gauge, digital	10-19
Force gauge, mechanical	6, 8, 9
Hardness tester, digital	67, 69-77
Hardness tester, Leeb	69-73
Hardness tester, Shore	65-68
Hardness testing, (UCI)	75-77
Integrated calliper gauge, digital	46-48
Leeb hardness tester, digital	69-73
Length meter, digital	46-48
Light measuring instrument	79, 80
Material thickness gauge, ultrasonic	57-64
Occupational safety	78-83
Shore hardness tester, analogue	66
Software	37-39
Sound level meter	81-83
Spring balances	5-8
Spring tester	36
Test stand, force-, manual	22-24
Test stand, force-, motorised	28-35
Test stand, Shore-, manual	68
Torque gauges	49-51
Wall thickness gauge	57-64

Force measurement accessories from page 40

1-jaw-clamp attachment	40
2 wide jaw grip attachment	40
3-point bending device	42
Adapter	45
Angle bracket	40
Attachments	45
Ball-shaped head, Stainless steel	42
Belt tension clamps	41, 43
Cable removal clamp	43
Connection cable	45
Door tester	45
Drum clamps	40
Fine point clamp	40
Flat jaw attachment	40
Grub screw	42
Handle bar, stainless steel	45
Long clamp	40
Parallel jaw grip	40
Pressure disc	42
Reducing sleeve	42
Roll clamps, eccentric	40
Roller tension clamps	41
Rolling-clamp attachment	40
Rope and thread clamp	40
Rope and thread tension clamps	40, 41, 43
Screw-in tension clamp	40, 44-41
Sensor	42
Small clamp, standard	43
Tensiometer attachment	45
Threaded adapters	42
Threaded pin	42
Tombstone tester	45
Wedge tension clamp	40, 41, 43
Wide jaw clamp	43









SAUTER Models A-Z

281/285	7
283	8
287/289	6
AFH FAST	37
AFH FD/AFH LD	38
AFI	39
CB	94
CD	92
CE HSx	86
CE WT	87
CJ	98
CK	92
CO	97
CP	90/91
CR	93
CT	95
CS	96/97
CW	100-102
DA	50
DB	51
DC Y1 - DC Y2	89
FA	9
FA-G	20
FC	11
FC 1K-BT	21
FH 500S71	26
FH-M	13
FH-S	12
FK	10
FL-G	20
FL-S	14
FL-M	15
FL TM	16
FS	18/19
FS-G	20
HB	66
HD	67
HK-D/-DB	70
HMM/-NP	71
HMO	73
HN-D	72
HO	76/77
LB	47
LD	48
SD-M	36
SO	79
SP	80
SU	81
SW	82/83
TB	53
TB-US	58
TC	54
TD-US	59
TE	55
TF	56
TG	56
THM-N/-S	28
TI	68
TN-EE	62
TN-GOLD	60
TN-US	61
TO-EE	64
TPE-N	25
TU-US	63
TVL 100FHS71	27
TVL 500FHS71	26
TVL	23
TVL-XS	22
TVM-N/-NL	32/33
TVO	29
TVO-S	30/31
TVP 500FHS71	27
TVP/-L	24
TVS	34/35
YKV	85

SAUTER Pictograms

 Adjusting program (CAL): For quick setting of the instrument's accuracy. External adjusting weight required	 WLAN data interface: To transfer data from the balance/measuring instrument to a printer, PC or other peripherals	 Protection against dust and water splashes IPxx: The type of protection is shown in the pictogram cf. DIN EN 60529:2000-09, IEC 60529:1989+A1:1999+A2:2013
 Calibration block: Standard for adjusting or correcting the measuring device	 Data interface Infrared: To connect relays, signal lamps, valves, etc.	 ZERO: Resets the display to "0"
 Peak hold function: Capturing a peak value within a measuring process	 Control outputs (optocoupler, digital I/O): To connect relays, signal lamps, valves, etc.	 Battery operation: Ready for battery operation. The battery type is specified for each device
 Scan mode: Continuous capture and display of measurements	 Analogue interface: To connect a suitable peripheral device for analogue processing of the measurements	 Rechargeable battery pack: Rechargeable set
 Push and Pull: The measuring device can capture tension and compression forces	 Analog output: For output of an electrical signal depending on the load (e.g. voltage 0 V – 10 V or current 4 mA – 20 mA)	 Plug-in power supply: 230V/50Hz in standard version for EU. On request GB, AUS or USA version available
 Length measurement: Captures the geometric dimensions of a test object or the movement during a test process	 Statistics: Using the saved values, the device calculates statistical data, such as average value, standard deviation etc.	 Integrated power supply unit: Integrated, 230V/50Hz in EU. More standards e.g. GB, AUS or USA on request
 Focus function: Increases the measuring accuracy of a device within a defined measuring range	 PC Software: To transfer the measurement data from the device to a PC	 Motorised drive: The mechanical movement is carried out by an electric motor
 Internal memory: To save measurements in the device memory	 Printer: A printer can be connected to the device to print out the measurement data	 Motorised drive: The mechanical movement is carried out by a synchronous motor (stepper)
 Data interface RS-232: Bidirectional, for connection of printer and PC	 Network interface: For connecting the scale/measuring instrument to an Ethernet network	 Fast-Move: The total length of travel can be covered by a single lever movement
 Profibus: For transmitting data, e.g. between scales, measuring cells, controllers and peripheral devices over long distances. Suitable for safe, fast, fault-tolerant data transmission. Less susceptible to magnetic interference.	 KERN Communication Protocol (KCP): It is a standardized interface command set for KERN balances and other instruments, which allows retrieving and controlling all relevant parameters and functions of the device. KERN devices featuring KCP are thus easily integrated with computers, industrial controllers and other digital systems	 Verification possible: Models with type approval for construction of verifiable systems
 Profinet: Enables efficient data exchange between decentralised peripheral devices (balances, measuring cells, measuring instruments etc.) and a control unit (controller). Especially advantageous when exchanging complex measured values, device, diagnostic and process information. Savings potential through shorter commissioning times and device integration possible	 GLP/ISO record keeping: Of measurement data with date, time and serial number. Only with SAUTER printers	 DAkkS calibration possible: The time required for DAkkS calibration is shown in days in the pictogram
 Data interface USB: To connect the measuring instrument to a printer, PC or other peripheral devices	 Measuring units: Weighing units can be switched to e.g. non-metric. Please refer to website for more details	 Factory calibration: The time required for factory calibration is specified in the pictogram
 Bluetooth* data interface: To transfer data from the balance/measuring instrument to a printer, PC or other peripherals	 Measuring with tolerance range (limit-setting function): Upper and lower limiting can be programmed individually. The process is supported by an audible or visual signal, see the relevant model	 Package shipment: The time required for internal shipping preparations is shown in days in the pictogram
		 Pallet shipment: The time required for internal shipping preparations is shown in days in the pictogram

Do you have questions about our products? Our customer consultants will be pleased to assist you:

Product Specialist Measuring Technology	Product Specialist Measuring Technology	Product Specialist Measuring Technology
 Irmgard Russo Tel. +49 7433 9933-208 info@sauter.eu	 Helga Biselli Tel. +49 7433 9933-188 info@sauter.eu	 Ralf Gutbrod Tel. +49 7433 9933-306 info@sauter.eu
Product Specialist Measuring Technology	FR, Maghreb, GB, IE, IS, BE, LU	DK, SE, FI, NO, PL, LV, LT, EE
 Andreas Vossler Tel. +49 7433 9933-243 info@sauter.eu	 Maren Möwert Tel. +49 7433 9933-132 Mobil +49 151 46143240 maren.moewert@kern-sohn.com	 Mark Hauder Tel. +49 7433 9933-310 Mobil +49 160 3378426 mark.hauder@kern-sohn.com
GR, CY, BG, HU, RO, SK, CZ, AL, Ex-Yugoslavia, CIS	North America, Africa, Asia, Middle East, Oceania, TR:	Germany (PC 4, 7), NL
 Ariana Sevcenco Tel. +49 7433 9933-203 Mobil +49 151 72434692 ariana.sevcenco@kern-sohn.com	 Corinna Matthes Tel. +49 7433 9933-215 Mobil +49 151 44568364 corinna.matthes@kern-sohn.com	 Taras Mikitisin Tel. +49 7433 9933-143 Mobil +49 171 5590115 mikitisin@kern-sohn.com
Technical Service	DAKKS Calibration Service Balances & Measuring Instruments	
 Stefan Rothmund Tel. +49 7433 9933-179 rothmund@kern-sohn.com	 Karl-Richard Fuchs Tel. +49 7433 9933-401 recalibration-instruments@kern-sohn.com	

Your advantages

fast

- 24 hours delivery service – order today, on its way tomorrow
- Sales & service hotline from 8:00 am to 5:00 pm

reliable

- 2 years warranty

diverse

- One-stop-shopping: from force gauges up to light measuring instruments – everything from one supplier
- Quick as a flash, find the product you want with the "Measuring instruments Quick-Finder" at www.sauter.eu



www.sauter.eu

Information on current product availability, product data sheets, user instructions, useful knowledge, technical glossary, images and much for you to download, practical topic areas, which will guide you to the right product in your industry as well as a smart search engine for measuring instruments



Our team of consultants

will assist you
from Monday to Friday
from 8:00 am to 5:00 pm

Retailer information

Sales conditions

All prices are valid as of January 1st 2023 until a new version of the SAUTER catalogue is released. In Europe, all prices do not include the applicable V.A.T.

Delivery Conditions: we supply ex works Balingen, i.e. the transport costs are invoiced. Any goods supplied, remain SAUTER's property until complete payment for the goods sold has been received.

 Delivery is usually via courier service.

 When you see this symbol by truck, please ask for prices.

Extract from general terms and conditions:

Court of jurisdiction/Legal domicile: 72336 Balingen, Germany; Commercial register N°: HRB 400865, AG Stuttgart; Managing director: Albert Sauter. For the full Terms and Conditions, please refer to the website. www.kern-sohn.com/en/kern/agbs.html

Price changes and product changes are likely in individual cases due to product modifications as well as error.

Sale or return: within 14 days of purchase. Not valid for order-specific adaptations such as special productions, cable extensions, special weights, etc. or test services such as calibration etc. Depending on the time and effort involved, there may be processing a mailto:ariana.sevcenco@kern-sohn.com nd storage costs, please ask for details.

Warranty: 2 years. (Does not apply to consumables such as batteries, rechargeable battery packs, etc.)

After-Sales-Service

Repair services within 1 week at our plant in Balingen, transportation costs are additional. Our expert Service technicians will be pleased to assist you and will make sure that your device is quickly back in operation.

Price reduction on a new device: if repair costs are exceeding the current value of the defective device, a new device will be offered at a discount price. This offer is valid only up to 2 years after warranty expiration.

Spare parts service within 48 hours, transportation costs are additional.

KERN – Measuring technology and testing services from a single source



SAUTER measuring equipment catalogue

Balances & Test service catalogue

Medical scales catalogue

Microscopes & refractometers catalogue

Test service brochure

Product group index 2023

01 Force measurement
5 – 45

A handheld force measurement device with a color display showing '0.00 N' and the SAUTER logo.

02 Length measurement
46 – 48

A vertical length measurement device with a digital display showing '0.00'.

03 Torque measurement
49 – 51

A torque measurement device with a circular dial and a digital display showing '0.0000'.

04 Coating thickness measurement
52 – 56

A handheld coating thickness measurement device with a digital display showing '0.0'.

05 Material thickness measurement
57 – 64

A handheld material thickness measurement device with a digital display showing '0.00' and a probe.

06 Hardness testing of plastics (Shore)
65 – 68

A Shore hardness testing device with a circular dial and a vertical probe.

07 Hardness testing of metals (Leeb)
69 – 74

A Leeb hardness testing device with a digital display and a probe.

08 Hardness testing of metals (UCI)
75 – 77

A UCI hardness testing device with a digital display and a probe.

09 Occupational safety/
Environment
78 – 83

A handheld occupational safety/environment device with a digital display showing '00.00'.

10 System solutions
industry 4.0/
Display devices
84 – 87

A system solutions display device with a red LED display showing '000000'.

11 Load cells
88 – 98

A rectangular load cell device with a cable and a digital display.

12 Scale kits
99 – 102

A scale kit including a digital display showing '0000' and various components.

Calibration service

103–104

NEW IN → 2023

Lots of individual possibilities with convincing performance and customized to your wishes and requirements. Please find here our new additions in proven SAUTER quality – be inspired.

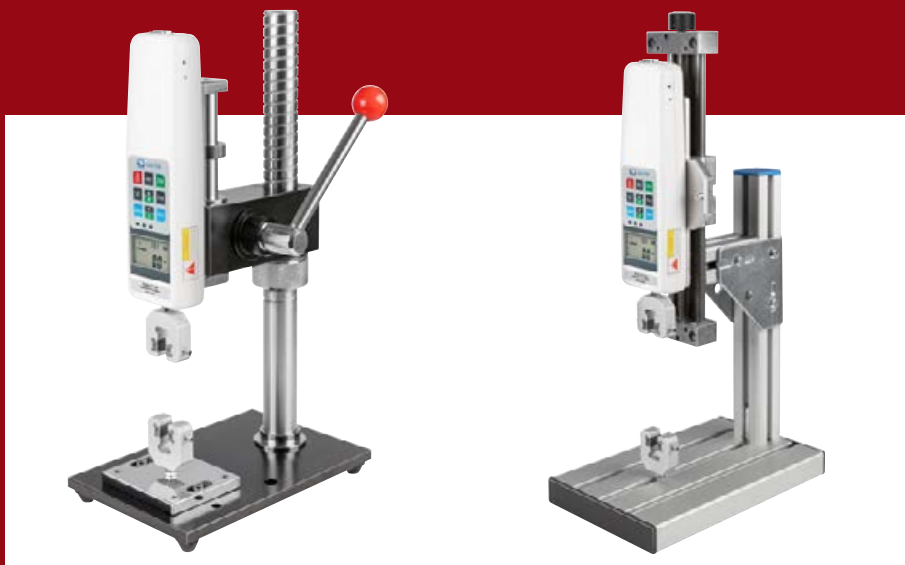

New to be tested at SAUTER: the practical all-in-one packages for fast, uncomplicated testing

→ FORCE MEASUREMENT BUNDLES SAUTER TVP 500FHS71, TVL 100FHS71

Details, see page 26/27



Safety with SAUTER: Quick check of the standing strength of gravestones

→ GRAVESTONE TESTERS
SAUTER FA-G · FL-G · FS-G

Details, see page 20



Who has the choice – is spoiled for choice: Sauter CW series of scale kits

Find the correct weighing solution for every application here

→ SAUTER CW SERIES SCALE KITS

A wide range of weighing processes require individual special solutions. We provide you special scale kits, with which you can implement customized weighing solutions. With the SAUTER scale kits you will still be more flexible in your application possibilities and benefit from a lower ordering effort as well as a price advantage.

Details, see page 100-102



01 FORCE MEASUREMENT

Note: All standard force-measuring devices are available with a factory calibration certificate as an option. All electronic force-measuring devices with a measuring range of ≤ 5 kN are also available with a DAkkS calibration certificate as an option. For details on our calibration services, please see page 103 or visit on the internet website www.sauter.eu



Andreas Vossler
Product specialist
Force measurement
Tel. +49 7433 9933-243
info@sauter.eu

Quick-Finder

Readout	Measuring range	Model	Price	Page
[d]	[Max]	SAUTER	excl. VAT, ex works €	
N	N			
0,001	2	FH 2	590,-	12
0,001	5	FH 5	590,-	12
0,002	5	FL 5	570,-	14
0,004	20	FS 2-20	1050,-	18
0,004	20	FS 4-20	1150,-	18
0,005	10	FH 10	590,-	12
0,005	10	FK 10	275,-	10
0,005	10	FL 10	570,-	14
0,01	1	283-152	99,-	8
0,01	10	FC 10	415,-	11
0,01	20	FH 20	590,-	12
0,01	25	FK 25	275,-	10
0,01	25	FL 20	570,-	14
0,01	50	FC 50	415,-	11
0,01	50	FH 50	590,-	12
0,01	50	FS 2-50	1050,-	18
0,01	50	FS 4-50	1150,-	18
0,01	50	SD 50N100	2520,-	36
0,01 0,05	1	289-100	81,-	6
0,02	3	283-252	110,-	8
0,02	50	FK 50	275,-	10
0,02	50	FL 50	570,-	14
0,02	100	FS 2-100	1050,-	18
0,02	100	FS 4-100	1150,-	18
0,02	100	SD 100N100	2520,-	36
0,04	200	FS 2-200	1050,-	18
0,04	200	FS 4-200	1150,-	18
0,05	6	283-302	110,-	8
0,05	10	FA 10	230,-	9
0,05	100	FH 100	590,-	12
0,05	100	FK 100	275,-	10
0,05	100	FL 100	570,-	14
0,05	200	SD 200N100	2330,-	36
0,05 0,5	5	289-102	81,-	6
0,1	10	283-402	110,-	8
0,1	20	FA 20	230,-	9
0,1	100	FC 100	415,-	11

Suitable test stands for your SAUTER force measuring device can be found from page 22 onwards

Readout	Measuring range	Model	Price	Page
[d]	[Max]	SAUTER	excl. VAT, ex works €	
N	N			
0,1	200	FH 200	590,-	12
0,1	250	FK 250	275,-	10
0,1	250	FL 200	570,-	14
0,1	500	FC 500	415,-	11
0,1	500	FH 500	590,-	12
0,1	500	FS 2-500	1050,-	18
0,1	500	FS 4-500	1150,-	18
0,1	500	SD 500N100	2520,-	36
0,1 0,5	10	289-104	92,-	6
0,2	25	283-422	115,-	8
0,2	500	FK 500	275,-	10
0,2	500	FL 500	570,-	14
0,25	50	FA 50	230,-	9
0,5	50	283-483	205,-	8
0,5	100	FA 100	230,-	9
0,5	1000	FH 1K	1000,-	13
0,5	1000	FK 1K	275,-	10
0,5	1000	FL 1K	650,-	14
1	100	283-502	215,-	8
1	200	FA 200	230,-	9
1	1000	FC 1K	415,-	11
1	1000	FK 1K-BT	1320,-	21
1	2000	FH 2K	1000,-	13
1	2000	FL 2K	690,-	15
1	5000	FH 5K	1270,-	13
2	200	283-602	220,-	8
2	300	FA 300	230,-	9
2	5000	FL 5K	1070,-	15
2,5	500	FA 500	230,-	9
5	500	283-902	255,-	8
5	10000	FH 10K	1500,-	13
5	10000	FL 10K	1250,-	15
10	20000	FH 20K	1500,-	13
10	20000	FL 20K	1290,-	15
10	50000	FH 50K	1750,-	13
50	100000	FH 100K	1970,-	13

Note: You will find a wide range of further spring balances with gram division at unter www.sauter.eu



SAUTER 289



SAUTER 287

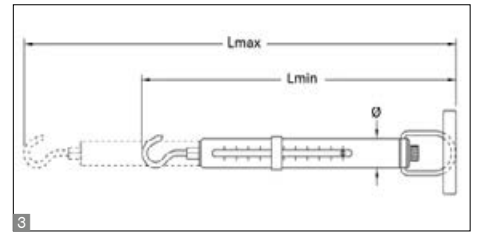

Mechanical weight and force measurement with quality spring for long service life

Features

- The very best price/performance ratio thanks to the transparent plastic housing, ideal for schools and educational institutions
- Newton scale: The SAUTER 289 range can display the results in Newtons instead of in grams, specifically for measuring tensile forces
- Double scale: For fast or precise recording of the measurement result
- High precision: Backlash-free spring bearing with integrated tare screw for highly-precise adjustment
- Non-fatigue stainless steel spring
- Abrasion-resistant, colour precision scale with high resolution

- Thanks to the rotating inner tube, the scale is always easy to read
- The bracket which is delivered as standard can easily be swapped for another suspension device, so that the system can be individually adapted to the items being weighed

Technical data

- Measuring precision: $\pm 0,3\%$ of [Max]
- Tare range: 20 % of [Max]

Accessories

- **1** Bracket for spring balances of 10- 1000 g/ 0,1- 10 N, SAUTER 287-A01, **€ 28,-**
- **2** Hook for spring balances 10-1000 g/ 0,1- 10 N, SAUTER 287-A02, **€ 28,-**

STANDARD **1 DAY** OPTION **ISO +4 DAYS**

Model	Measuring range [Max] N	Division [d] N	Load support	3 Dimensions			Price excl. of VAT ex works €	Option	
				Lmin mm	Lmax mm	Ø mm		Factory calibration certificate	€
SAUTER 289-100	1	0,01 0,05	hook	230	335	12,2	81,-	961-1610	168,-
SAUTER 289-102	5	0,05 0,5	hook	230	335	12,2	81,-	961-1610	168,-
SAUTER 289-104	10	0,1 0,5	hook	230	335	12,2	92,-	961-1610	168,-

Model	Measuring range [Max] g	Division [d] g	Load support	3 Dimensions			Price excl. of VAT ex works €	Option	
				Lmin mm	Lmax mm	Ø mm		Factory calibration certificate	€
SAUTER 287-100	10	0,1	clip	225	330	12,2	82,-	961-100	89,-
SAUTER 287-102	20	0,2	clip	225	330	12,2	82,-	961-100	89,-
SAUTER 287-104	50	0,5	clip	225	330	12,2	82,-	961-100	89,-
SAUTER 287-106	100	1	clip	225	330	12,2	82,-	961-100	89,-
SAUTER 287-108	500	5	clip	225	330	12,2	82,-	961-100	89,-
SAUTER 287-110	1000	10	clip	225	330	12,2	92,-	961-100	89,-



SAUTER 281



SAUTER 285

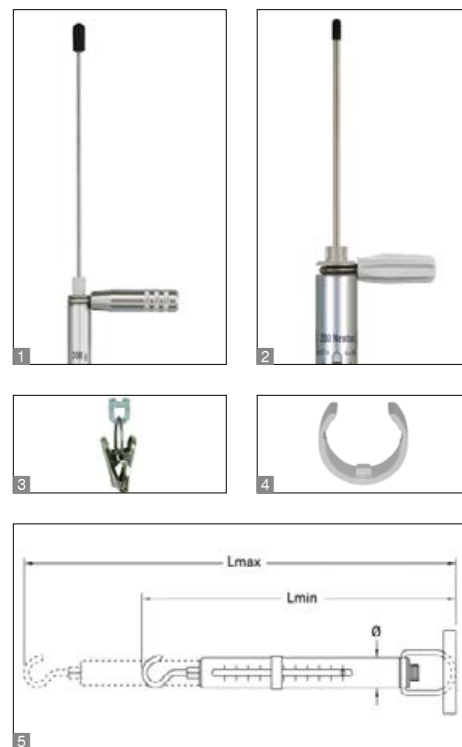

Precise, mechanical spring balances in robust aluminium housing with g/kg readout

Features

- Aluminium scale tube: robust, long service life, rustproof
- Gram/Kilogram scale: Measuring result display in grams/kilograms instead of N
- Double scale: For fast or precise recording of the measurement result
- Compressive force measurement: possible using an optional pressure set, see accessories
- Drag pointer and carrying handle: as standard for all models of the SAUTER 285 range
- Suspension bow: thanks to the rotating suspension bow the scale can always be aligned to be at the very best line of sight

- High precision: Backlash-free spring bearing with integrated tare screw for highly-precise adjustment
- Non-fatigue stainless steel spring
- Clip loop which can be freely rotated of the lower suspension bracket by 360° for models with $[\text{Max}] \le 1 \text{ kg}$
- High-quality workmanship: Wear-resistant, colour-anodised precision scale with high resolution for accurate readout of the measuring result

Technical data

- Measuring precision: $\pm 0,3 \%$ of $[\text{Max}]$
- Tare range: 20 % of $[\text{Max}]$

Accessories

- 1 Pressure-Set, suitable for models with weighing range $< 2,5 \text{ kg}/25 \text{ N}$, SAUTER 281-890, € 78,-
- 2 Pressure-Set, suitable for models with weighing range $\ge 5 \text{ kg}/50 \text{ N}$, SAUTER 285-890, € 89,-
- 3 Clip, suitable for models with weighing range $\le 2,5 \text{ kg}/25 \text{ N}$, SAUTER 281-151-002, € 9,-
- 4 Drag pointer for spring balances, suitable for models with weighing range $< 2,5 \text{ kg}/25 \text{ N}$, SAUTER 281-051-001, € 8,-
- Drag pointer for spring balances, suitable for models with weighing range $\ge 5 \text{ kg}/50 \text{ N}$, SAUTER 285-897, € 45,-



Model	Weighing range [Max]	Division [d]	Load support	5 Dimensions			Price excl. of VAT ex works €	Option Factory calibration certificate	
				Lmin	Lmax	ϕ		KERN	€
SAUTER	g	g		mm	mm	mm			
281-101	10	0,1	clip	220	300	12	105,-	961-100	89,-
281-151	30	0,25	clip	220	300	12	92,-	961-100	89,-
281-201	60	0,5	clip	220	300	12	92,-	961-100	89,-
281-301	100	1	clip	220	300	12	92,-	961-100	89,-
281-401	300	2	clip	225	325	12	105,-	961-100	89,-
281-451	600	5	clip	225	325	12	110,-	961-100	89,-
281-601	1000	10	clip	225	325	12	105,-	961-100	89,-
281-752	2500	20	hook	225	325	12	115,-	961-100	89,-
285-052	5000	50	hook	370	510	32	200,-	961-100	89,-
285-102	10000	100	hook	370	510	32	215,-	961-101	110,-
285-202	20000	200	hook	370	510	32	205,-	961-101	110,-
285-352	35000	500	hook	370	460	32	215,-	961-101	110,-
285-502	50000	500	hook	370	460	32	255,-	961-101	110,-

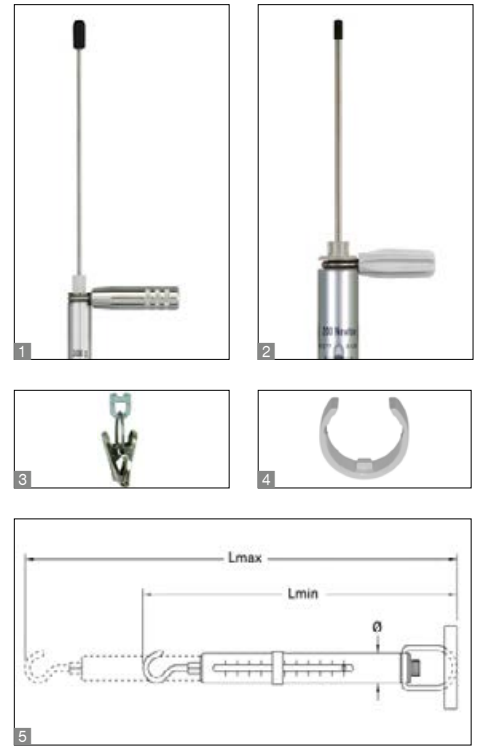

Precise, mechanical force gauge in robust aluminium housing with Newton readout

Features

- Aluminium scale tube: robust, long service life, rustproof
- Newton scale: Measuring result displayed in Newton
- Double scale: For fast or precise recording of the measurement result
- Compressive force measurement: possible using an optional pressure set, see accessories
- Carrying handle as standard
- Drag pointer as standard on all models of the SAUTER 283 range with [Max] ≥ 50 N
- Suspension bow: thanks to the rotating suspension bow the scale can always be aligned to be at the very best line of sight on all models of the SAUTER 283 range with [Max] ≥ 50 N
- High precision: Backlash-free spring bearing with integrated tare screw for highly-precise adjustment

- Non-fatigue stainless steel spring
- Clip loop which can be freely rotated of the lower suspension bracket by 360°
- High-quality workmanship: Wear-resistant, colour-anodised precision scale with high resolution for accurate readout of the measuring result

Technical data

- Measuring precision: $\pm 0,3\%$ of [Max]
- Tare range: 20 % of [Max]

Accessories

- **1** Pressure-Set, suitable for models with weighing range < 2,5 kg/25 N, SAUTER 281-890, **€ 78,-**
- **2** Pressure-Set, suitable for models with weighing range ≥ 5 kg/50 N, SAUTER 285-890, **€ 89,-**
- **3** Clip, suitable for models with weighing range ≤ 2,5 kg/25 N, SAUTER 281-151-002, **€ 9,-**
- **4** Drag pointer for spring balances, suitable for models with weighing range < 2,5 kg/25 N, SAUTER 281-051-001, **€ 8,-**
- Drag pointer for spring balances, suitable for models with weighing range ≥ 5 kg/50 N, SAUTER 285-897, **€ 45,-**

STANDARD



1 DAY

OPTION



+4 DAYS

Model	Measuring range [Max] N	Division [d] N	Load support	5 Dimensions			Price excl. of VAT ex works €	Option Factory calibration certificate	
				Lmin mm	Lmax mm	Ø mm		KERN	€
SAUTER									
283-152	1	0,01	hook	225	305	12	99,-	961-1610	168,-
283-252	3	0,02	hook	225	325	12	110,-	961-1610	168,-
283-302	6	0,05	hook	225	325	12	110,-	961-1610	168,-
283-402	10	0,1	hook	225	325	12	110,-	961-1610	168,-
283-422	25	0,2	hook	225	325	12	115,-	961-1610	168,-
283-483	50	0,5	hook	370	510	32	205,-	961-1610	168,-
283-502	100	1	hook	370	510	32	215,-	961-1610	168,-
283-602	200	2	hook	370	510	32	220,-	961-1610	168,-
283-902	500	5	hook	370	510	32	255,-	961-1610	168,-



Mechanical force gauge for tensile and compressive force measurements with peak hold function

Features

- Dual scale: shows Newton and kg
- Turnable display unit for an easy zero setting of the instrument
- Peak hold function by drag pointer
- Can be mounted on all manual test stands
- Zeroing by a short push of the switch
- **1** Delivered in a robust carrying case
- **2** Standard attachments as shown, extension rod: 90 mm

Technical data

- Measuring precision: 1 % of [Max]
- Overall dimensions W×D×H 232×60×51 mm
- Thread: M6
- Net weight approx. 0,55 kg

Accessories

- **2** Standard attachments as standard, set can be reordered, SAUTER AC 43, € 61,-
- Further accessories see www.sauter.eu and page 40 et seqq.

STANDARD				OPTION	
PEAK	PUSH/PULL	ZERO	1 DAY	ISO	+4 DAYS

Model	Measuring range [Max] N	Readout [d] N	Price excl. of VAT ex works €	Option Factory calibration certificate					
				Tensile force		Compressive force		Tensile/Compressive force	
				KERN	€	KERN	€	KERN	€
SAUTER FA 10	10	0,05	230,-	961-1610	168,-	961-2610	178,-	961-3610	315,-
FA 20	20	0,1	230,-	961-1610	168,-	961-2610	178,-	961-3610	315,-
FA 50	50	0,25	230,-	961-1610	168,-	961-2610	178,-	961-3610	315,-
FA 100	100	0,5	230,-	961-1610	168,-	961-2610	178,-	961-3610	315,-
FA 200	200	1	230,-	961-1610	168,-	961-2610	178,-	961-3610	315,-
FA 300	300	2	230,-	961-1610	168,-	961-2610	178,-	961-3610	315,-
FA 500	500	2,5	230,-	961-1610	168,-	961-2610	178,-	961-3610	315,-

Further calibration options on request



Robust, digital force gauge for tensile and compressive force measurements

Features

- Turnable display: automatic direction identification
- Secure operability due to the ergonomic design
- Peak-Hold function to capture peaks (value is "frozen" for approx. 10 seconds) or Track function mode for a continuous measurement indication
- Selectable measuring units: N, lbf, kgf, ozf
- Auto-Power-Off
- **1** Standard attachments as shown, extension rod: 90 mm
- Can be mounted on all SAUTER test stands up to 5 kN

Technical data

- Measuring precision: 0,5 % of [Max]
- Overload protection: 200 % of [Max]
- Overall dimensions W×D×H 195×82×35 mm
- Thread: M8
- Ready for use: Batteries included, 6×1.5 V AA
- Net weight approx. 0,75 kg

Accessories

- **2** With one of the two optional attachments for tensile strength testing, the SAUTER FK can become a tensiometer for testing the material tension characteristics of cables, threads, wires, twine etc. (up to \varnothing 5 mm): Illustration shows accessories SAUTER FK-A02
- Tensiometer attachment with Safe-insert function: Pull and release to insert the running cable in between the rolls, for tensile strength testing up to 250 N, aluminium attachment, rolls can be adjusted inwards, SAUTER FK-A01, **€ 230,-**
- Tensiometer kit for high-capacity tensile strength testing up to 1000 N, steel attachment and steel rolls, rolls cannot be adjusted, SAUTER FK-A02, **€ 320,-**
- **1** Standard attachments as standard, set can be reordered, SAUTER AC 430, **€ 55,-**
- Further accessories see www.sauter.eu and page 40 et seqq.

STANDARD

PEAK
 PUSH/PULL
 ZERO
 BATT
 230 V
 1 DAY

OPTION

ISO
 +4 DAYS

Model	Measuring range [Max] N	Readout [d] N	Price excl. of VAT ex works €	Option Factory calibration certificate					
				Tensile force		Compressive force		Tensile/Compressive force	
SAUTER				KERN	€	KERN	€	KERN	€
FK 10	10	0,005	275,-	961-1610	168,-	961-2610	178,-	961-3610	315,-
FK 25	25	0,01	275,-	961-1610	168,-	961-2610	178,-	961-3610	315,-
FK 50	50	0,02	275,-	961-1610	168,-	961-2610	178,-	961-3610	315,-
FK 100	100	0,05	275,-	961-1610	168,-	961-2610	178,-	961-3610	315,-
FK 250	250	0,1	275,-	961-1610	168,-	961-2610	178,-	961-3610	315,-
FK 500	500	0,2	275,-	961-1610	168,-	961-2610	178,-	961-3610	315,-
FK 1K	1000	0,5	275,-	961-1620	215,-	961-2620	215,-	961-3620	385,-

Further calibration options on request

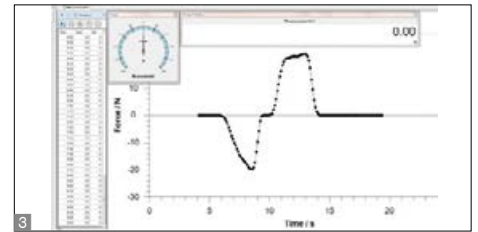

Compact force gauge for tensile and compressive force measurements

Features

- Turnable display with backlight
- Peak-Hold function to capture the peak value or Track function for continuous display of measurement
- Metal housing for durable use in harsh environmental conditions
- Capacity display: A bar lights up to show how much of the measuring range is still available
- Measuring with tolerance range (limit-setting function): Upper and lower limit adjustable, between 10 and 100 % of [Max], in pull and push direction. The process is supported by an acoustic and visual signal
- Safety: If loads exceed 110 % of the measuring range, the device will give clear acoustic and visual signals
- Internal memory for up to 500 measurement values
- USB data interface and USB interface cable as standard

- Selectable: AUTO-OFF function or permanent operation
- 1 Delivered in a robust carrying case
- Selectable measuring units: N, kgf, ozf, lbf
- 2 Standard attachments as shown, extension rod: 90 mm
- Can be mounted on all SAUTER test stands up to 5 kN

Technical data

- Measuring precision: 0,3 % of [Max]
- Transmission rate to PC: up to 200 measured values/second
- Overload protection: 150 % of [Max]
- Overall dimensions WxDxH 145x73x34 mm
- Thread: M6
- Rechargeable battery pack integrated, as standard, operating time up to 20 h without backlight, charging time approx. 4 h
- Net weight approx. 0,95 kg

Accessories

- 3 Data transfer software with graphic display of the measurement process, Force-time, SAUTER AFH FAST, € 115,- Force-displacement only in combination with SAUTER LB, SAUTER AFH FD, € 710,-
- 2 Standard attachments as standard, set can be reordered, SAUTER AC 43, € 61,-
- Further accessories see www.sauter.eu and page 40 et seqq.

STANDARD



OPTION



Model	Measuring range [Max] N	Readout [d] N	Price excl. of VAT ex works €	Option DAKkS calibration certificate					
				Tensile force		Compressive force		Tensile/Compressive force	
				DAKkS KERN	€	DAKkS KERN	€	DAKkS KERN	€
SAUTER FC 10	10	0,01	415,-	963-161	168,-	963-261	168,-	963-361	305,-
FC 50	50	0,01	415,-	963-161	168,-	963-261	168,-	963-361	305,-
FC 100	100	0,1	415,-	963-161	168,-	963-261	168,-	963-361	305,-
FC 500	500	0,1	415,-	963-161	168,-	963-261	168,-	963-361	305,-
FC 1K	1000	1	415,-	963-162	205,-	963-262	205,-	963-362	375,-

Further calibration options on request



Save with our practical bundles of test stand, force gauge and matching clamps, e.g. SAUTER FH 500S71, consisting of:
 - 1 x FH 500
 - 1 x AE 500 (Details see page 44)
 You can find our bundles on page 26/27

Universal digital force gauge for tensile and compressive force measurements with integrated load cell

Features

- Turnable display with backlight
- **1** Can be mounted on all SAUTER test stands up to 5 kN
- Data interface RS-232 as standard
- **2** Standard attachments as shown, extension rod: 90 mm
- **3** Delivered in a robust carrying case
- Selectable measuring units: N, kgf, lbf
- Peak-Hold function to capture the peak value or Track function for continuous display of measurement
- Measuring with tolerance range (limit-setting function): Upper and lower limit adjustable, in pull and push direction. The process is supported by an audible and visual signal
- Auto-Power-Off
- Internal memory for up to 10 measurement values
- Mini Statistics Kit: calculates the average result from up to 10 stored measured values, as well as min., max., n

Technical data

- Transfer rate to PC: approx. 25 measured values per second
- Measuring precision: 0,5 % of [Max]
- Overload protection: 150 % of [Max]
- Overall dimensions WxDxH 230x66x36 mm
- Thread: M6
- Rechargeable battery pack integrated, as standard, operating time up to 12 h without backlight, charging time approx. 4 h
- Net weight approx. 0,65 kg

Accessories

- Data transfer software with graphic display of the measurement process, Force-time, SAUTER AFH FAST, € 115,-
Force-displacement only in combination with SAUTER LD, SAUTER AFH LD, € 270,-
Force-displacement only in combination with SAUTER LB, SAUTER AFH FD, € 710,-
- RS-232/PC-Connection cable to connect models from the SAUTER FH range to a PC, SAUTER FH-A01, € 50,-
- **2** Standard attachments as standard, set can be reordered, SAUTER AC 43, € 61,-
- Further accessories see www.sauter.eu and page 40 et seqq.

STANDARD



OPTION



Model	Measuring range [Max] N	Readout [d] N	Price excl. of VAT ex works €	Option DAKKS calibration certificate					
				Tensile force		Compressive force		Tensile/Compressive force	
SAUTER				DAKKS KERN	€	DAKKS KERN	€	DAKKS KERN	€
FH 2	2	0,001	590,-	-	-	-	-	-	-
FH 5	5	0,001	590,-	-	-	-	-	-	-
FH 10	10	0,005	590,-	963-161	168,-	963-261	168,-	963-361	305,-
FH 20	20	0,01	590,-	963-161	168,-	963-261	168,-	963-361	305,-
FH 50	50	0,01	590,-	963-161	168,-	963-261	168,-	963-361	305,-
FH 100	100	0,05	590,-	963-161	168,-	963-261	168,-	963-361	305,-
FH 200	200	0,1	590,-	963-161	168,-	963-261	168,-	963-361	305,-
FH 500	500	0,1	590,-	963-161	168,-	963-261	168,-	963-361	305,-

Further calibration options on request



01

Universal digital force gauge for tensile and compressive force measurements with external load cell

Features

- Turnable display with backlight
- Data interface RS-232 as standard
- Delivered in a robust carrying case
- Selectable measuring units: N, kN, kgf, tf
- Peak-Hold function to capture the peak value or Track function for continuous display of measurement
- Measuring with tolerance range (limit-setting function): Upper and lower limit adjustable, in pull and push direction. The process is supported by an audible and visual signal
- Auto-Power-Off
- Internal memory for up to 10 measurement values
- Mini Statistics Kit: calculates the average result from up to 10 stored measured values, as well as min., max., n

Technical data

- Transfer rate to PC: approx. 25 measured values per second
- Measuring precision: 0,5 % of [Max]
- Overload protection: 150 % of [Max]
- Housing dimensions W×D×H 230×66×36 mm
- Rechargeable battery pack integrated, as standard, operating time up to 12 h without backlight, charging time approx. 4 h
- **1** Tension loops and compression plates are included in delivery
- Cable length approx. 3 m

Accessories

- Data transfer software with graphic display of the measurement process, Force-time, SAUTER AFH FAST, € 115,-
Force-displacement only in combination with SAUTER LD, SAUTER AFH LD, € 270,-
Force-displacement only in combination with SAUTER LB, SAUTER AFH FD, € 710,-
- RS-232/PC-Connection cable to connect models from the SAUTER FH range to a PC, SAUTER FH-A01, € 50,-
- Further accessories see www.sauter.eu and page 40 et seqq.

STANDARD



OPTION



Model	Measuring range [Max] kN	Readout [d] N	Dimensions load cell W×D×H mm	Thread	Price excl. of VAT ex works €	Option DAKKS calibration certificate (≤ 5 kN)/Factory calibration certificate (> 5 kN)					
						Tensile force		Compressive force		Tensile/Compressive force	
SAUTER						KERN	€	KERN	€	KERN	€
FH 1K	1	0,5	76×51×19	M12	1000,-	963-162	205,-	963-262	205,-	963-362	375,-
FH 2K	2	1	76×51×19	M12	1000,-	963-162	205,-	963-262	205,-	963-362	375,-
FH 5K	5	1	76,2×51×28,2	M12	1270,-	963-163	285,-	963-263	285,-	963-363	500,-
FH 10K	10	5	76,2×51×28,2	M12	1500,-	961-164	370,-	961-264	370,-	961-364	550,-
FH 20K	20	10	76,2×51×28,2	M12	1500,-	961-164	370,-	961-264	370,-	961-364	550,-
FH 50K	50	10	108×76×25,5	M18×1,5	1750,-	961-165	370,-	961-265	370,-	961-365	550,-
FH 100K	100	50	178×125×51	M30×2	1970,-	961-166	410,-	961-266	410,-	961-366	600,-

Further calibration options on request



01

Universal digital force gauge with graphic-assisted display and integrated load cell

Features

- Turnable display with backlight
- Peak-Hold function to capture the peak value or Track function for continuous display of measurement
- Metal housing for durable use in harsh environmental conditions
- Can be mounted on all SAUTER test stands up to 5 kN
- Capacity display: A bar lights up to show how much of the measuring range is still available
- Measuring with tolerance range (limit-setting function): Upper and lower limit adjustable, in pull and push direction. The process is supported by an visual signal
- Internal memory for up to 500 measurement values

- Continuous analogue output: Linear voltage signal in dependence to the load (-2 to +2V)
- USB data interface, as standard
- 1 Standard attachments: as shown
- Selectable measuring units: N, kN, kgf, lbf
- 2 Delivered in a robust carrying case

Technical data

- Transfer rate to PC: approx. 25 measured values per second
- Measuring precision: 0,2 % of [Max]
- Overload protection: 120 % of [Max]
- Overall dimensions W×D×H 175×75×30 mm
- Thread: M6
- Rechargeable battery pack integrated, as standard, operating time up to 10 h without backlight, charging time approx. 8 h
- Net weight approx. 0,55 kg

Accessories

- Plug-In for data transfer of measuring data from the measuring instrument and transfer to a PC, e.g. in Microsoft Excel®, SAUTER AFI-2.0, € 95,-
- Data transfer software with graphic display of the measurement process, force-time, SAUTER AFH FAST, € 115,-
Force-displacement only in combination with SAUTER LD, SAUTER AFH LD, € 270,-
Force-displacement only in combination with SAUTER LB, SAUTER AFH FD, € 710,-
- USB cable, included in delivery, can be ordered separately, USB/PC connection cable (USB-A/USB mini), SAUTER FL-A01, € 50,-
- RS-232 adapter cable, SAUTER FL-A04, € 50,-
- Holders for object fixation and other accessories, please see www.sauter.eu or see page 40 et seq.

STANDARD



OPTION



Model	Measuring range [Max] N	Readout [d] N	Price excl. of VAT ex works €	Option DAKkS calibration certificate					
				Tensile force		Compressive force		Tensile/Compressive force	
				DAKkS KERN	€	DAKkS KERN	€	DAKkS KERN	€
SAUTER FL 5	5	0,002	570,-	-	-	-	-	-	-
FL 10	10	0,005	570,-	963-161	168,-	963-261	168,-	963-361	305,-
FL 20	25	0,01	570,-	963-161	168,-	963-261	168,-	963-361	305,-
FL 50	50	0,02	570,-	963-161	168,-	963-261	168,-	963-361	305,-
FL 100	100	0,05	570,-	963-161	168,-	963-261	168,-	963-361	305,-
FL 200	250	0,1	570,-	963-161	168,-	963-261	168,-	963-361	305,-
FL 500	500	0,2	570,-	963-161	168,-	963-261	168,-	963-361	305,-
FL 1K	1000	0,5	650,-	963-162	205,-	963-262	205,-	963-362	375,-

Further calibration options on request



Powerful digital force gauge with graphic assisted display for tensile and compressive force measurements with external load cell

Features

- Premium force gauge with external load cell, tension loops included
- Turnable display with backlight
- Peak-Hold function to capture the peak value or Track function for continuous display of measurement
- Metal housing for durable use in harsh environmental conditions
- Can be mounted on all SAUTER test stands from 1 kN
- Capacity display: A bar lights up to show how much of the measuring range is still available
- Measuring with tolerance range (limit-setting function): Upper and lower limit adjustable, in pull and push direction. The process is supported by a visual signal
- Internal memory for up to 500 measurement values
- Continuous analogue output: Linear voltage signal in dependence to the load (-2 to +2V)
- USB data interface, as standard
- Selectable measuring units: N, kN, kgf, ozf, lbf
- Delivered in a robust carrying case

Technical data

- Transfer rate to PC: approx. 25 measured values per second
- Measuring precision: 0,2 % of [Max]
- Overload protection: 120 % of [Max]
- Overall dimensions WxDxH 175x75x30 mm
- Dimensions load cell WxDxH
FL 2K: 76,2x51x19 mm
FL 5K, 10K, 20K: 76,2x51x28 mm
- Thread: M12
- Rechargeable battery pack integrated, as standard, operating time up to 10 h without backlight, charging time approx. 8 h
- Net weight approx. 0,55 kg

Accessories

- Plug-In for data transfer of measuring data from the measuring instrument and transfer to a PC, e.g. in Microsoft Excel®, SAUTER AFI-2.0, **€ 95,-**
- Data transfer software with graphic display of the measurement process, Force-time, SAUTER AFH FAST, **€ 115,-**
Force-displacement only in combination with SAUTER LD, SAUTER AFH LD, **€ 270,-**
Force-displacement only in combination with SAUTER LB, SAUTER AFH FD, **€ 710,-**
- USB cable, included in delivery, can be ordered separately, USB/PC connection cable (USB-A/USB mini), SAUTER FL-A01, **€ 50,-**
- RS-232 adapter cable, SAUTER FL-A04, **€ 50,-**
- Holders for object fixation and other accessories, please see www.sauter.eu or see page 40 et seq.

STANDARD



OPTION



Model	Measuring range	Readout	Price excl. of VAT ex works €	Option DAKkS calibration certificate (≤ 5 kN)/ Factory calibration certificate (> 5 kN)					
				Tensile force		Compressive force		Tensile/Compressive force	
	[Max] N	[d] N		KERN	€	KERN	€	KERN	€
SAUTER									
FL 2K	2000	1	690,-	963-162	205,-	963-262	205,-	963-362	375,-
FL 5K	5000	2	1070,-	963-163	285,-	963-263	285,-	963-363	500,-
FL 10K	10000	5	1250,-	961-164	370,-	961-264	370,-	961-364	550,-
FL 20K	20000	10	1290,-	961-164	370,-	961-264	370,-	961-364	550,-

Further calibration options on request



◀ **Note:** The shown load cell is not included in the scope of delivery! Combine the FL TM with a load cell suitable for your application from the SAUTER program, such as CR P1, CR Q1, CS P1 or CS Q1
You can find our load cells at page 88-98

01



Digital Premium force gauge with graphics display for tensile and compressive force measurements, prepared for external load cells

Features

- **1** Premium force-measuring for connection of external load cells (load cell, tension loops and pressure plates not included with delivery)
- Adjustable nominal loads: 5 N, 10 N, 25 N, 50 N, 100 N, 250 N, 500 N, 1 kN, 2,5 kN, 5 kN, 10 kN, 20 kN, 50 kN
- Suitable for strain gauge sensors: up to 500 N characteristic value 1 mV/V, from 1 kN characteristic value 2 mV/V
- Maximum resolution 2500 d
- Peak-Hold function to capture the peak value or Track function for continuous display of measurement
- Metal housing for durable use in harsh environmental conditions
- Capacity display: A bar lights up to show how much of the measuring range is still available
- Measuring with tolerance range (limit-setting function): Upper and lower limit adjustable, in pull and push direction. The process is supported by an visual signal

- Internal data memory for up to 500 values
- Continuous analogue output: Linear voltage signal in dependence to the load (-2 to +2V)
- USB data interface, as standard
- Selectable measuring units: N, kN, kgf, lbf, ozf
- **2** Delivered in a robust carrying case

Technical data

- Transfer rate to PC: approx. 25 measured values per second
- Measuring precision: 0,2 % of [Max]
- Overload protection: 120 % of [Max]
- Overall dimensions W×D×H 175×75×30 mm
- Rechargeable battery pack integrated, as standard, operating time up to 10 h without backlight, charging time approx. 8 h
- Net weight approx. 1,8 kg

Accessories

- Plug-In for data transfer of measuring data from the measuring instrument and transfer to a PC, e.g. in Microsoft Excel®, SAUTER AFI-2.0, **€ 95,-**
- Data transfer software with graphic display of the measurement process, Force-time, SAUTER AFH FAST, **€ 115,-**
Force-displacement only in combination with SAUTER LD, SAUTER AFH LD, **€ 270,-**
Force-displacement only in combination with SAUTER LB, SAUTER AFH FD, **€ 710,-**
- USB cable, included in delivery, can be ordered separately, USB/PC connection cable (USB-A/USB mini), SAUTER FL-A01, **€ 50,-**
- RS-232 adapter cable, SAUTER FL-A04, **€ 50,-**
- **Option FL-C01: Solder connector for FL TM to load cell and adjusting the device, SAUTER FL-C01, € 100,-**

STANDARD



OPTION



Model	Price excl. of VAT ex works €	Option DAkKS calibration certificate (≤ 5 kN)/ Factory calibration certificate (> 5 kN)							
		Option	Measuring range optional load cell	Tensile force		Compressive force		Tensile/Compressive force	
SAUTER		Load cell		KERN	€	KERN	€	KERN	€
FL TM*	550,-	Load cells see page 90-97	≤ 500 N	963-161	168,-	963-261	168,-	963-361	305,-
			≤ 2 kN	963-162	205,-	963-262	205,-	963-362	375,-
			≤ 5 kN	963-163	285,-	963-263	285,-	963-363	500,-
			≤ 20 kN	961-164	370,-	961-264	370,-	961-364	550,-
			≤ 50 kN	961-165	370,-	961-265	370,-	961-365	550,-

! * ONLY WHILE STOCKS LAST!

Further calibration options on request

INDIVIDUAL CUSTOMIZED SOLUTIONS DESIGNED TO YOUR REQUIREMENTS

You haven't found a matching clamping solution in our assortment?

No problem, we will develop the matching clamping system that is tailored to your test system. With innovative solutions and many years of experience, we provide your team or company with technological support and jointly develop the suitable clamping system.

CUSOS – perfectly tailored to you and your requirements

The development of your customised clamping system is carried out using the latest technologies. From the idea, during the development, the manufacturing process, to the finished product, we and our partners use the latest and most modern techniques.

Contact us today and ask for your individual solution.



Stefan Herrmann
Product Manager SAUTER
Force Measurement

Tel. +49 7433 9933-214
stefan.herrmann@kern-sohn.com



CUSTOMIZED
SOLUTION SERVICE

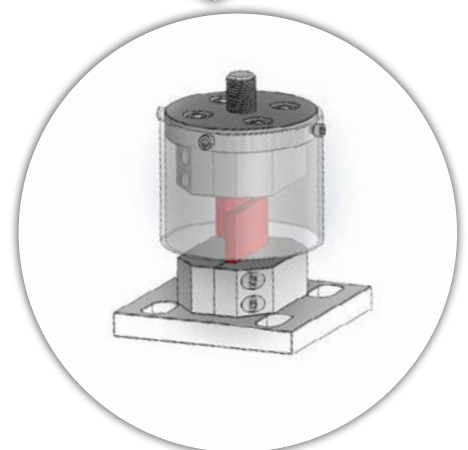
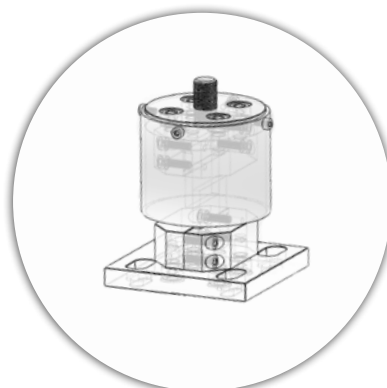
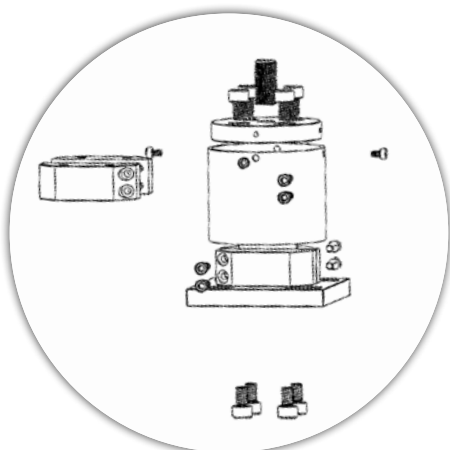
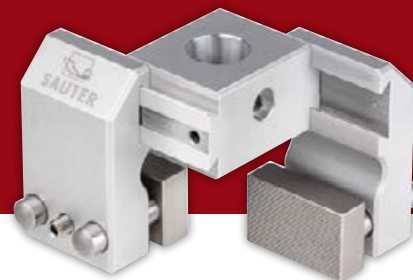



Measurement of forces in different tensile or compression directions possible with only one measuring device

Premium force gauge with integrated load cell (optional) and connection possibility for up to 4 external load cells



Supplied in a high-quality and robust system case (systemainer® T-LOC) including plug-in power supply and USB cable type C

Use with integrated load cell

The SAUTER FS premium force gauge has an integrated load cell for tensile and compressive force applications. Either mobile for rapid testing or stationary integrated into a test stand or production line, the multifunction display allows all the values recorded to be read off at a glance in real time. Via the integrated interface, the data can be sent to a PC or laptop for further processing.



Use with external load cells

The SAUTER FS premium force gauge is compatible with all SAUTER strain gauge load cells, see page 88 et seq. Up to 4 external load cells can be connected simultaneously. If an external measuring channel is used, the internal load cell is deactivated as long as an external load cell is connected.

Tip: Order the practical system case (systemainer® T-LOC) for storing and transporting of accessories, clamps, sensors, etc. at the same time, SAUTER FS TKZ, see *accessories*



Can be mounted on all SAUTER test stands, illustration shows optional accessories, as well as the SAUTER TVL-XS manual test stand



Simultaneous measurement on up to four channels. External sensors with sensor data memory, optionally available, see chapter load cells.



Compact force gauge with internal load cell (up to max. 500 N) for fast and mobile force measurements. Illustration shows optional accessories, SAUTER AE 500 screw tension clamp

Features

- 3,5" touchscreen
- Standard version with 2 or 4 measuring channels for external force sensors (subsequently expandable from 2 to 4)
- An internal load cell is possible (is deactivated if an external load cell is connected)
- Suitable for 4-wire and 6-wire sensors with strain gauges
- Two-point adjustment with weights or numerical adjustment possible
- The specific data of an external sensor are stored directly in the connector
- USB interface for data transfer and power supply as standard
- Internal device memory (16 GB)
- Adjustable SI units: kg, N, kN, mN, MN, Nm, kNm, mNm
- Tolerance function
- Track function for continuous measurement display
- Peak value measurement
- Mountable on all SAUTER test stands

Technical data

- High resolution: up to 10000 points per measurement channel
- Storage of measured values as well as their transmission to the interface with up to 1000 Hz per measuring channel
- Measurement accuracy:
 - with internal load cell: 0,1 % of [Max]
 - with external load cell: among other things from the load cells used
- Overall dimensions W×D×H 71×31×180 mm
- Overload protection: 150 % of [Max] with internal load cell
- Thread on load receptor: M6 (outer)
- Rechargeable battery pack integrated, as standard, operating time up to 8 h without backlight, charging time approx. 8 h
- External mains adapter, for connection to the USB-C connector, standard
- Net weight approx. 0,40 kg

Accessories

- A/D converter module, only for FS 2 and FS 2-xxx models, SAUTER FS 34, € 205,-
- Stainless steel handle bar with rubber grip, SAUTER AFK 02, € 105,-
- Transport case, e.g. for accessories, SAUTER FS TKZ, € 115,-
- Standard attachments, SAUTER AC 43, € 61,-
- Hook for tensile and fracture testing up to 500 N, thread: M6, 1 item, SAUTER AC 49, € 21,-
- Plug-In for data transfer of measuring data from the measuring instrument and transfer to a PC, e.g. in Microsoft Excel®, SAUTER AFI-2.0, € 95,-
- Data transfer software with graphic display of the measurement process, force-time, force-displacement only in combination with SAUTER LD, SAUTER AFH LD, € 270,-*
* only 1 channel can be used at any one time
- **Suitable load cells see page 88 et seq.**
- Holders for object fixation and other accessories, please see www.sauter.eu or see page 40 et seq.

Optional calibration, see page 103
 Calibration is recommended for each load cell!
 Assembly and adjustment of load cell, connector and sensors must be ordered separately, see table below,
 SAUTER FS 401-FS 408

Order example SAUTER FS force gauge with 2 load cells:

1x	FS 2-500	2-channel force gauge with integrated load cell for tension/compression force measurements
1x	963-361	DAkKS calibration certificate tension/compression force up to 500 N
1x	CO 100-Y1	Miniature compression load cell up to 1 kN
1x	FS 403	Two-point adjustment up to 2 kN, incl. plug and memory for SAUTER FS
1x	963-262	DAkKS calibration certificate compression force up to 2 kN
1x	CS 500-3P2	Stainless steel "S" load cell for tension/compression force up to 5 kN
1x	963-363	DAkKS calibration certificate tension/compression force up to 5 kN
1x	FS 404	Two-point adjustment up to 5 kN, incl. connector and memory for SAUTER FS



Model	Measuring range internal load cell	Readability internal load cell	Internal load cell	Number of measuring channels	Price excl. of VAT ex works
	[Max] N	[d] N			
SAUTER FS 2	-	-	-	2	930,-
FS 2-20	20	0,004	•	2	1050,-
FS 2-50	50	0,01	•	2	1050,-
FS 2-100	100	0,02	•	2	1050,-
FS 2-200	200	0,04	•	2	1050,-
FS 2-500	500	0,1	•	2	1050,-
SAUTER FS 4	-	-	-	4	1050,-
FS 4-20	20	0,004	•	4	1150,-
FS 4-50	50	0,01	•	4	1150,-
FS 4-100	100	0,02	•	4	1150,-
FS 4-200	200	0,04	•	4	1150,-
FS 4-500	500	0,1	•	4	1150,-

Service required for use with external sensors:

Model	Adjustment of optional, external sensors	Measuring range	Price excl. of VAT ex works
		[Max] kN	
SAUTER FS 401	Numeric*	-	135,-
FS 402	Two-point	0,05	160,-
FS 403		2	170,-
FS 404		5	195,-
FS 405		20	205,-
FS 406		50	205,-
FS 407		120	225,-
FS 408		250	240,-

*only for sensors > 250 kN



Fast testing of the stability of tombstones in accordance with VSG 4.7

1 SAUTER FA-G

- Disc plate for pressure tests
- Stainless steel handle with rubber covering for secure handling
- No electrical power supply required due to mechanical measuring system
- Real time or peak hold switch to observe transients or capture peaks by a drag indicator
- For tensile force and compressive force testing
- Scope of delivery:
 - 1 × FA 500
 - 1 × AE 08
 - 1 × AFH 04

2 SAUTER FL-G

- Ideal for the documented certification of specialist stone-cutter companies
- Rechargeable battery with long operating time (significantly more than 8 hours), so it is possible to use the device for a whole working day, in mobile mode
- Function to set limits: This is where you can program a stability limit value. If this limit value is exceeded, the device emits a visual signal. In this way, the measuring result does not need to be read off each time
- Stainless steel handle with rubber covering for secure handling
- Wide pressure plate with foam rubber surface, so that the tombstone does not get scratched when force is applied
- Robust metal housing for permanent use under harsh environmental conditions
- Scope of delivery:
 - 1 × FL 500
 - 1 × AE 08
 - 1 × AFH 04

3 SAUTER FS-G

- Can also be used outside of tombstone testing due to the internal as well as external load cell
- 3,5" touchscreen
- USB interface for data transfer and power supply as standard
- Internal device memory (16 GB)
- Tolerance function
- Track function for continuous measurement display
- Peak value measurement
- Scope of delivery:
 - 1 × FS 2-500
 - 1 × AE 08
 - 1 × AFK 02

For further details and a wide range of accessories, see Internet

STANDARD

PEAK PUSH/PULL ZERO 1 DAY

OPTION

ISO +4 DAYS

STANDARD

PEAK PUSH/PULL MEMORY USB ANALOG UNIT TOL

STANDARD

PEAK SCAN PUSH/PULL MEMORY USB KCP PROTOCOL TOL

STANDARD

ZERO ACCU 230 V 1 DAY

OPTION

SOFTWARE DAkks +4 DAYS ISO +4 DAYS

STANDARD

ZERO ACCU 230 V 1 DAY

OPTION

DAkks +4 DAYS ISO +4 DAYS

SAUTER		FA 500G	FL 500G	FL 1KG	FS 500G
Measuring range [Max] N		500	500	1000	500
Readout [d] N		2,5	0,2	0,5	0,1
Measuring precision of [Max]		1 %	0,2 %	0, 2%	0, 1%
Overload protection of [Max]		150 %	120 %	120 %	150 %
Price excl. of VAT ex works €		355,-	690,-	810,-	1160,-
Option Factory calibration certificate	Tensile force	961-1610, € 168,-	961-161, € 168,-	961-162, € 205,-	961-161, € 168,-
	Compressive force	961-2610, € 178,-	961-261, € 168,-	961-262, € 205,-	961-261, € 168,-
	Tensile/Compressive force	961-3610, € 315,-	961-361, € 305,-	961-362, € 375,-	961-361, € 305,-
Option DAkks calibration certificate	Tensile force	-	963-161, € 168,-	963-162, € 205,-	963-161, € 168,-
	Compressive force	-	963-261, € 168,-	963-262, € 205,-	963-261, € 168,-
	Tensile/Compressive force	-	963-361, € 305,-	963-362, € 375,-	963-361, € 305,-



Compact force measuring instrument

Features

- Checking the consistency of sprayed concrete is essential to ensure the maximum strength of the concrete during the curing process
- The FC 1K-BT determines exactly the forces required for the needle to penetrate the concrete. This allows reliable conclusions to be made regarding the compressive strength of the concrete during the dry phase
- Peak-Hold function to capture the peak value or Track function for continuous display of measurement
- Metal housing for durable use in harsh environmental conditions
- Capacity display: A bar lights up to show how much of the measuring range is still available
- Limit value function, programming of Max./ Min., with output of acoustic and optical signal per ok indication
- Safety: If loads exceed 110 % of the measuring range, the device will give clear acoustic and visual signals
- Internal data memory for up to 500 measured values
- Delivered in a robust carrying case
- Turnable display with backlight
- Selectable: AUTO-OFF function or continuous operation, charge indicator

Technical data

- Transmission rate to PC: up to 200 measured values/second
- Accuracy: 0,3 % of [Max]
- Overload protection: 150 % of [Max]
- Housing dimensions WxDxH 145x73x34 mm
- Net weight approx. 1,8 kg
- Selectable measuring units: N, kgf, ozf, lbf
- Robust, cleanable and portable construction
 - Built-in 1000 N force load cell
 - Rapid and simple changing of the penetration needle
 - Inverted display for better readability
 - Live peak force value for immediate monitoring
 - Measurement precision $\pm 0,1 \%$
 - Memory for up to 500 measurements
 - USB interface
- Penetration needle and adapter
 - Removable if necessary
 - Needle diameter: 3 mm
 - Upper angle: 60 degrees
 - Length: 15 mm
 - Included: 15 needles

Accessories

- Needle for concrete tester SAUTER BT-A01, **€ 34,-**
- Further accessories see www.sauter.eu

STANDARD



OPTION



Model	Measuring range	Division	Price excl. of VAT ex works €	Option DAkKS calibration certificate			
				Tensile force		Compressive force	
				DAkKS KERN	€	DAkKS KERN	€
SAUTER FC 1K-BT	[Max] N 1000	[d] N 1	1320,-	963-162	205,-	963-262	205,-



Manual test stand for precise compressive force measurement in the range up to 100 N

Features

- **1** The redesigned, superfine spindle enables exact testing in a force-measurement range up to 100 N in particularly fine steps and, in conjunction with the fine-dosing crank, ensures safe, reliable operation
- **2** Main areas of application: Testing of low levels of force with short distances, such as, for example, testing keyboard overlays, biological samples (e.g. strength of leaves, etc.), blister packs (e.g. force required to push tablets out, etc.)
- For vertical and horizontal use
- High level of security at repeated measurements
- Large base plate with high versatility of fastening objects
- Suitable for all SAUTER force measuring devices up to 100 N (not included in delivery)

Technical data

- Travel distance per knob rotation (stroke per one turn): 2 mm
- Overall dimensions W×D×H 300×250×160 mm
- Net weight approx. 4,6 kg

Save with our practical bundles of test stand, force gauge and matching clamps, e.g. SAUTER TVL 100FHS71, consisting of:

- 1 × TVL-XS
- 1 × FH 100 (Details see page 12)
- 2 × AE 500 (Details see page 44)

You can find our bundles on page 26/27

STANDARD



Model	Measuring range	Price
	[Max]	excl. of VAT
	N	ex works
		€
SAUTER		
TVL-XS	100	710,-

1 ONLY WHILE STOCKS LAST!



Manual test stand for highly accurate tensile and compressive force measurements, with length measurement

Features

- NEW: TVL-XLS: consisting of: TVL + TVL-XL (see accessories)
- For vertical and horizontal use
- Precise measurement results
- High level of security at repeated measurements
- Large base plate with high versatility of fastening objects
- Suitable for all SAUTER force measuring devices up to 1000 N (not included in delivery)
- SAUTER TVL: Hook with M6 thread as standard
- Digital length meter SAUTER LA (without interface) as standard
 - Measuring range: max. 200 mm
 - Readout: 0,01 mm
 - Zero setting possible
 - Pre-length can be set manually
- **1** Model TVL and TVL-XLS in size comparison

Technical data

- Maximum travel distance: 230 mm
- Travel distance per knob rotation (stroke per one turn): 3 mm
- Base plate with threaded hole M6
- Extended work zone with TVL-XL: +340 mm
- Overall dimensions WxDxH 151x234x465 mm

Accessories

- **2** Extension kit for SAUTER TVL, extends the working area by 340 mm, enabling larger test pieces to be measured. The travel distance (spindle height from base plate) remains the same: 230 mm. Overall dimensions WxDxH 35x110x344 mm, Net weight approx. 3,0 kg, can be retrofitted, SAUTER TVL-XL, **€ 330,-**
- Digital length measuring device, measuring range 200 mm, readout 0,01 mm, details see page 47, SAUTER LB 200-2, **€ 1140,-**
- Mounting the length measuring device LB onto a SAUTER test stand at the factory, SAUTER LB-A02, **€ 210,-**
- Data transfer software with graphic display of the measurement process, Force-time, SAUTER AFH FAST, **€ 115,-**
Force-displacement only in combination with SAUTER LB, SAUTER AFH FD, **€ 710,-**

Save with our practical bundles of test stand, force gauge and matching clamps, e.g. SAUTER TVL 500FHS71, consisting of:

- 1 x TVL
- 1 x FH 500 (Details see page 12)
- 2 x AE 500 (Details see page 44)

You can find our bundles on page 26/27

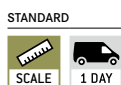

Model	Measuring range	Net weight approx.	Price excl. of VAT ex works €
	[Max] N	kg	
SAUTER			
TVL-XLS NEW	500	12	790,-
TVL	1000	9	485,-

NEW New model



SAUTER TVP



SAUTER TVP-L

Manual test stands for compressive force measurements, also with digital length measurement

Features

- Provides quick and consistent testing
- High level of security at repeated measurements
- Provides maximum versatility and precise measuring results
- Slide construction for distance measurement
- Large base plate with high versatility of fastening objects
- Suitable for all SAUTER force gauges up to 500 N (not included in delivery)
- SAUTER TVP-L: Digital length meter
 - Measuring range: 100 mm
 - Readout: 0,01 mm
 - Zero setting possible
 - Pre-length can be set manually

Technical data

- Maximum work zone: 315 mm
- Maximum stroke length: 78 mm
- Base plate with threaded hole M6
- Overall dimensions W×D×H 150×233×420 mm
- Net weight approx. 11 kg

Accessories

- Digital length measuring device, measuring range 200 mm, readout 0,01 mm, details see page 47, SAUTER LB 200-2, **€ 1140,-**
- Mounting the length measuring device LB onto a SAUTER test stand at the factory, SAUTER LB-A02, **€ 210,-**
- Data transfer software with graphic display of the measurement process, Force-time, SAUTER AFH FAST, **€ 115,-**
Force-displacement only in combination with SAUTER LB, SAUTER AFH FD, **€ 710,-**

Save with our practical bundles of test stand, force gauge and matching clamps, e.g. SAUTER TVP 500FHS71, consisting of:

- 1 × TVP
- 1 × FH 500 (Details see page 12)
- 2 × AE 500 (Details see page 44)

You can find our bundles on page 26/27

STANDARD

TVP-L

Model	Measuring range [Max] N	Price excl. of VAT ex works €
SAUTER TVP	500	335,-
SAUTER TVP-L	500	485,-



Universal attachment for test stands for 90 degree peel tests

Features

- **1** The attachment for peel tests, SAUTER TPE-N has been specially developed for peel testing up to 500 N. Typically this involves pulling a bonded material layer from a base material. As a general rule, the significant value in this process is the force required to pull away the top layer from bonded material
- The attachment can be fitted onto all SAUTER force measuring test stands quickly and easily and thereby offers the highest level of flexibility in terms of travel path, measuring range, sample fixings, ecc.
- The attachment has been designed in the way, that a bonded material, e.g. adhesive tape, plasters, ecc., or an appropriate basic medium can be applied to the moving carriage. The test item is fixed to the force measuring device with a suitable clamp (both not included in the scope of delivery). Then the carriage is aligned such that the start of the test item is vertically directly below the force measuring device. By moving the test stand upwards, the carriage is moved and the test item is peeled off at a 90-degree angle to the surface
- Suitable for all SAUTER force measuring device up to 500 N (not included in delivery)
- Suitable for SAUTER test stands TVO 500N300, TVO 1000N500S, TVO 2000N500S, (not included in delivery)

Technical data

- Maximum stripping length: 200 mm
- Overall dimensions W×D×H 215×420×50 mm
- Net weight approx. 4,6 kg

STANDARD



Model	Measuring range	Price
	[Max]	excl. of VAT
	N	ex works
		€
SAUTER		
TPE-N	500	1310,-

1 ONLY WHILE STOCKS LAST!



The practical all-in-one package for rapid, simple testing

FH 500S71

- All-in-One: Digital force-measuring device incl. clamp
- For rapid, simple testing of forces up to 500 N
- Assembly and configuration of the parts is not required and therefore saves time and effort
- For tensile force and compressive force testing

TVL 500FHS71

- All-in-One: Test stand with digital force-measuring device and 2 clamps
- For manual testing with a pitch of 3 mm/rotation and for forces up to 500 N
- Assembly and configuration of the parts is not required and therefore saves time and effort
- For tensile force and compressive force testing

Accessories

- Data transfer software with graphic display of the measurement process, Force-time, SAUTER AFH FAST, € 115,-

Accessories

- Digital length measuring device, measuring range 200 mm, readout 0,01 mm, details see page 47, SAUTER LB 200-2, € 1140,-
- Mounting the length measuring device LB onto a SAUTER test stand at the factory, SAUTER LB-A02, € 210,-
- Data transfer software with graphic display of the measurement process, Force-time, SAUTER AFH FAST, € 115,-
- Force-displacement only in combination with SAUTER LB, SAUTER AFH FD, € 710,-

STANDARD

--	--	--	--	--	--	--	--	--	--	--

TVL

OPTION

--	--	--	--

+4 DAYS +4 DAYS

Model	Measuring range [Max] N	Readout [d] N	Scope of delivery	Price excl. of VAT ex works €	Option DAKkS calibration certificate					
					Tensile force		Compressive force		Tensile/Compressive force	
					DAKkS KERN	€	DAKkS KERN	€	DAKkS KERN	€
FH 500S71	500	0,1	1× FH 500 1× AE 500	710,-	963-161	168,-	963-261	168,-	963-361	305,-
TVL 500FHS71	500	0,1	1× TVL 1× FH 500 2× AE 500	1380,-	963-161	168,-	963-261	168,-	963-361	305,-



The practical all-in-one package for rapid, simple testing

TVP 500FHS71

- All-in-One: Digital force-measuring device incl. clamp
- For compressive force testing of switches, buttons etc. up to 500 N, for example
- Assembly and configuration of the parts is not required and therefore saves time and effort
- For compressive force testing

TVL 100FHS71

- All-in-One: Test stand with digital force-measuring device and 2 clamps
- For precise, manual testing through a pitch of 2 mm/rotation
- Assembly and configuration of the parts is not required and therefore saves time and effort
- For tensile force and compressive force testing

Accessories

- Data transfer software with graphic display of the measurement process, Force-time, SAUTER AFH FAST, € 115,-

Accessories

- Data transfer software with graphic display of the measurement process, Force-time, SAUTER AFH FAST, € 115,-

STANDARD

OPTION

Model	Measuring range [Max] N	Readout [d] N	Scope of delivery	Price excl. of VAT ex works €	Option DAkkS calibration certificate					
					Tensile force		Compressive force		Tensile/Compressive force	
					DAkkS KERN	€	DAkkS KERN	€	DAkkS KERN	€
TVP 500FHS71	500	0,1	1× TVP 1× FH 500 1× AE 500	1160,-	963-161	168,-	963-261	168,-	963-361	305,-
TVL 100FHS71	100	0,05	1× TVL 1× FH 100 2× AE 500	1480,-	963-161	168,-	963-261	168,-	963-361	305,-



SAUTER THM 500N500S

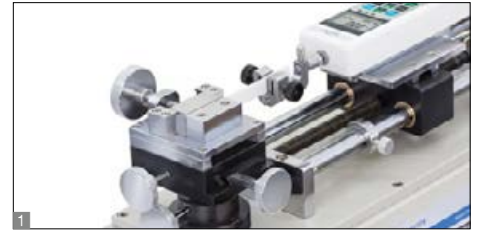

Motorised test stand with digital display for horizontal force measurement where highest standards are required

Features

- THM 500N500S: Step motor for greatest ease of use
 - for constant speed from the smallest to the maximum load
 - allows testing at minimum speed and full load
 - for higher positioning accuracy. Precise starting and stopping, without overrun, even at high speeds
 - precise adjustment of the process speed using the information shown on the display
- Easy to use
- Efficient working
- Robust design and heavy duty metal construction
- 1 THM 500N500N: Linear adjustable jaw vice. The clamping vice can be locked and finely adjusted sideways and up/down using the setting wheel
- Repeat function for fatigue tests
- Digital speed display to read the process speed straightaway
- Premium operating panel:
 - Digital speed display
 - Digital repeat function display
 - Control of the test stand using PC software SAUTER AFH

- 2 Figure shows the premium operating panel of SAUTER THM 500N500N
- Solid and versatile fixing options of SAUTER force measuring devices, see *accessories* page 40
- Suitable for all SAUTER force gauges up to 500 N (not included in delivery)

Technical data

- 3 THM-N
 - Minimum distance between left and right object fastening: 30 mm
 - Maximum travel distance: 220 mm (protected by electronic end switches)
 - Overall dimensions W×D×H 550×170×345 mm
 - Net weight approx. 34 kg
- THM-S
 - Maximum travel distance: 240 mm (protected by electronic end switches)
 - Overall dimensions W×D×H 695×235×300 mm
 - Net weight approx. 48 kg

Accessories

- Only THM-S: Linear potentiometer for length measurement, measuring range: 300 mm, readability: LD. For details see page 48, SAUTER LD, € 680,-
- Only THM-S: Mounting the length measuring device LD onto a SAUTER test stand at the factory, SAUTER LD-A06, € 300,-
- Only THM-S: Data transfer software with graphic display of the measurement process, Force-time, SAUTER AFH FAST, € 115,- Force-displacement only in combination with SAUTER LD, SAUTER AFH LD, € 270,-

STANDARD		OPTION	
THM-N	THM-S	THM-S	THM-S

Model	Measuring range	Speed range	Motor	Price excl. of VAT ex works €
	[Max]			
SAUTER	N	mm/min		
THM 500N500N	500	50-500	Electric motor	2790,-
THM 500N500S	500	1-500	Step motor	3970,-

1 ONLY WHILE STOCKS LAST!



Robust premium test stand for laboratory applications

Features

- Motorised test stand for tension/compression force testing
- Table-top design for comfortable operation
- Robust design for durable use
- Easy-to-access safety switch-off
- Upper and lower end point, can be set individually
- Automatic or manual operation mode
- Suitable for all SAUTER force gauges up to 500 N, e.g. SAUTER FH-S, for details see page 12 (not included in delivery)

Technical data

- Maximum tensile and compressive force: 500 N
- Maximum travel distance: 270 mm
- Speed accuracy: 2 % of [Max]
- Overall dimensions W×D×H 570×428×236 mm
- Net weight approx. 26 kg

Accessories

- Digital length measuring device, measuring range 300 mm, readout 0,01 mm, details see page 47, SAUTER LB 300-2, **€ 1250,-**
- Mounting the length measuring device LB onto a SAUTER test stand at the factory, SAUTER LB-A02, **€ 210,-**
- Data transfer software with graphic display of the measurement process, Force-time, SAUTER AFH FAST, **€ 115,-**
Force-displacement only in combination with SAUTER LB, SAUTER AFH FD, **€ 710,-**

STANDARD		OPTION	
ELECTRO	2 DAYS	SCALE	SOFTWARE

Model	Measuring range	Speed range	Maximum travel distance	Price excl. of VAT ex works €
SAUTER	[Max] N	mm/min	mm	
TVO 500N300	500	15-300	270	2630,-



Premium test stand in table-top version – with precise step motor



Solid and flexible fixing options for many terminals and accessories from the SAUTER product range, see *accessories*



A wide range of application possibilities because of its large travelling distance



Interface for data transmission from the SAUTER FH measuring device and for controlling the test stand with SAUTER AFH software

Motorised vertical test stand SAUTER TVO-S

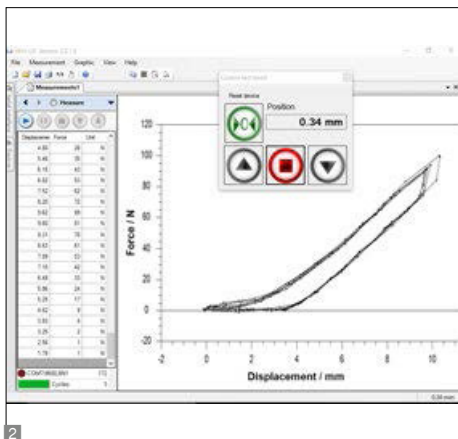

01

Features

- Motorised test stand for tension/compression force testing
- Step motor for greatest ease of use
 - for constant speed from the smallest to the maximum load
 - allows testing at minimum speed and full load
 - for higher positioning accuracy. Precise starting and stopping, without overrun, even at high speeds
 - precise adjustment of the process speed using the information shown on the display
- Automatic or manual operation mode
- **1** Premium operating panel:
 - Digital speed display
 - Digital repeat function display
 - Control of the test stand using PC software SAUTER AFH **2**
- Table-top design for comfortable operation
- Robust construction
- **3** Fixation of SAUTER force measuring devices up to 2 kN possible
- The large diagram shows the TVO 1000N500S test stand with: SAUTER FH force measuring device, length measuring device SAUTER LD as well as mounts for the force measuring device and test objects, not supplied with the product

Technical data

- Speed accuracy: 0,5 % of [Max]
- Positioning accuracy when shutting down: ± 0,05 mm

Accessories

- Linear potentiometer for length measurement, measuring range: 300 mm (TVO 500)/700 mm (TVO 1000 & TVO 2000), readability: 0,01 mm. For details see page 48, SAUTER LD, **€ 680,-**
- Mounting the length measuring device LD onto a SAUTER test stand at the factory, SAUTER LD-A06, **€ 300,-**
- Data transfer software with graphic display of the measurement process, Force-time, SAUTER AFH FAST, **€ 115,-**
Force-displacement only in combination with SAUTER LD, SAUTER AFH LD, **€ 270,-**
- **3** Holder for force gauges with external load cell on test stands, for comfortable reading of the measured value, SAUTER TVO-A01, **€ 125,-**

STANDARD	OPTION
STEPPER 2 DAYS	SCALE SOFTWARE

Model	Measuring range [Max] N	Speed range mm/min	Maximum travel distance mm	Price excl. of VAT ex works €
SAUTER TVO 500N500S	500	1-500	270	4240,-
SAUTER TVO 1000N500S	1000	1-500	500	4300,-
SAUTER TVO 2000N500S	2000	1-500	700	6150,-

01



Test stand with electric motor for standard measurements



Premium operating panel
 - Digital speed display
 - Digital repeat function

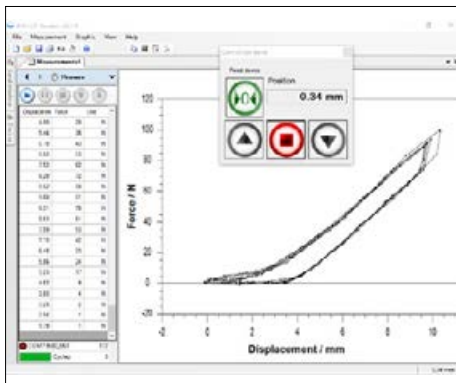

Control of the test stand using PC software SAUTER AFH



Solid and flexible fixing options for many terminals and accessories from the SAUTER product range

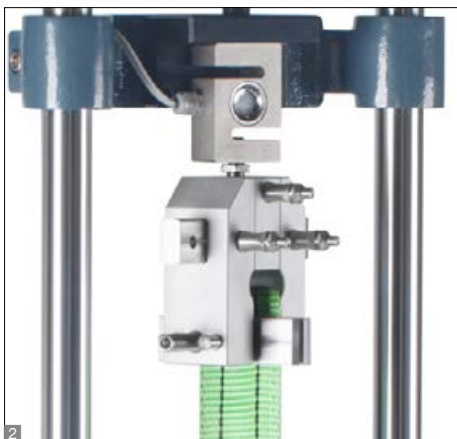

Features

- Force controlled automatic switchoff, teststop after achieving an adjusted limit load, only in connection with a SAUTER FH force gauge
- Maximum travel distance protected by electronic end switches
- SAUTER LA length measuring device as standard, to read the travel distance with a readout of 0,01 mm
- Particularly flexible mounting options for the most variable force measuring devices, such as, SAUTER FC, FH, FK, FL:
 - 1 Direct mounting of measuring devices with internal load cell up to a measuring range of 500 N (only for TVM 5000N230N)
 - 2 Direct mounting of the external load cell on the traverse, starting with 1000 N measurement range and higher
 - 3 Holder for force measuring devices of the SAUTER FH range with external load cell
- The large figure shows the TVM-N test stand with: SAUTER FH force measuring device, SAUTER LB length measuring device, longer guide columns as well as mount for force measuring device and test objects, not supplied with the product

Technical data

- Maximum travel distance: 210 mm
- Speed accuracy: 3 % of [Max]

Accessories

- Digital length measuring device, measuring range 300 mm, readout 0,01 mm, details see page 47, SAUTER LB 300-2, € 1250,-
- Mounting the length measuring device LB onto a SAUTER test stand at the factory, SAUTER LB-A02, € 210,-
- Data transfer software with graphic display of the measurement process, Force-time, SAUTER AFH FAST, € 115,-
Force-displacement only in combination with SAUTER LB, SAUTER AFH FD, € 710,-
- 3 Holder for force measuring devices of the SAUTER FH range with external load cell, SAUTER TVM-A01, € 95,-

STANDARD OPTION

Model	Measuring range [Max] N	Speed range mm/min	Length of columns mm	Price excl. of VAT ex works €
SAUTER TVM 5000N230N	5000	10-230	635	2960,-
SAUTER TVM 5000N230NL	5000	10-230	1135	3410,-
SAUTER TVM 10KN120N	10000	30-120	1135	3990,-
SAUTER TVM 20KN120N	20000	30-120	1135	5230,-
SAUTER TVM 30KN70N*	30000	5-70	1135	4400,-

1 * ONLY WHILE STOCKS LAST!



01



Premium test stand with step motor for precise testing up to 50 kN



Premium operating panel

- Digital speed display: shows the displacement speed
- Digital repeat function for long-term stress test

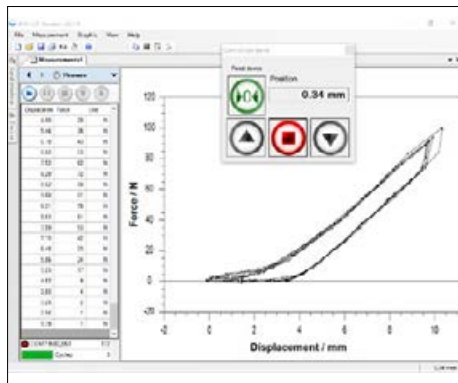

Control of the test stand using PC software SAUTER AFH

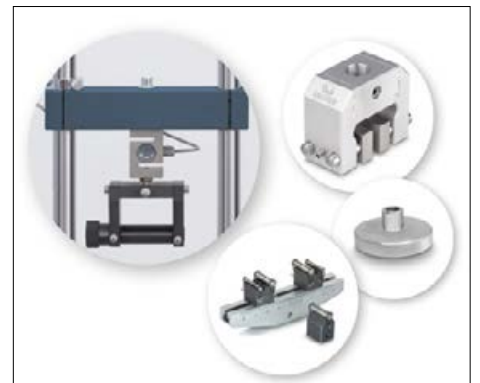

Solid and flexible fixing options for many terminals and accessories from the SAUTER product range

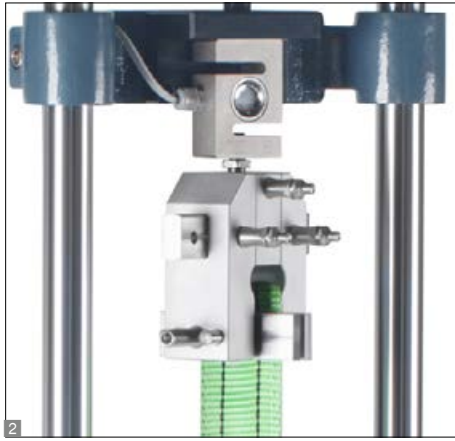

Features

- Motorised test stand for tension/compression force testing
- Step motor for greatest ease of use
 - for constant speed from the smallest to the maximum load
 - allows testing at minimum speed and full load
 - for higher positioning accuracy. Precise starting and stopping, without overrun, even at high speeds
 - precise adjustment of the process speed using the information shown on the display
- Maximum travel distance protected by electronic end switches
- Large working area by means of long guide columns as standard, which allows a wide range of fixing options
- SAUTER LA length measuring device as standard, to read the travel distance with a readout of 0,01 mm
- Particularly flexible mounting options for the most variable force measuring devices, such as, for example, SAUTER FC, FH, FK, FL:
 - 1 Direct mounting of measuring devices with internal load cell up to a measuring range of 500 N (only for TVS 5000N240)
 - 2 Direct mounting of the external load cell on the traverse, starting with 1000 N measurement range and higher
 - 3 Holder for force measuring devices of the SAUTER FH range with external load cell

- The large figure shows the TVS test stand with: SAUTER FH force measuring device, SAUTER LD length measuring device, longer guide columns as well as mount for force measuring device and test objects, not supplied with the product
- For force-displacement testing: Please order the optional SAUTER LD length measuring device as well as the SAUTER AFH LD software with the product

Technical data

- Maximum travel distance: 210 mm
- Speed accuracy: 1 % of [Max]
- Positioning accuracy when shutting down: ± 0,05 mm

Accessories

- Linear potentiometer for length measurement, measuring range: 300 mm, readability: 0,01 mm. For details see page 48, SAUTER LD, € 680,-
- Mounting the length measuring device LD onto a SAUTER test stand at the factory, SAUTER LD-A06, € 300,-
- Data transfer software with graphic display of the measurement process, Force-time, SAUTER AFH FAST, € 115,-
Force-displacement only in combination with SAUTER LD, SAUTER AFH LD, € 270,-
- 3 Holder for force measuring devices of the SAUTER FH range with external load cell, SAUTER TVM-A01, € 95,-

STANDARD		OPTION	
STEPPER	2 DAYS	SCALE	SOFTWARE

Model	Measuring range [Max] N	Speed range mm/min	Length of columns mm	Price excl. of VAT ex works €
SAUTER TVS 5000N240	5000	1-240	1135	6050,-
SAUTER TVS 10KN100	10000	1-200	1135	7600,-
SAUTER TVS 20KN100	20000	1-70	1135	7620,-
SAUTER TVS 30KN80*	30000	1-70	1135	6150,-
SAUTER TVS 50KN80	50000	1-70	1135	10810,-

1 * ONLY WHILE STOCKS LAST!



Manual test stand for tensile and compressive testing of springs, medium version up to 500 N

Features

- Spring tester for tension and compression tests
- Measuring device integrated in housing
-  Integrated thermal printer
- Digital length measuring unit SAUTER LA as standard:
 - Manual zero adjustment possible
 - Pre-length can be set manually
 - Readout: 0,01 mm
- 10 memories to print out the results or to calculate average values
- Measuring with tolerance range (limit-setting function): Upper and lower limit adjustable, in pull and push direction. The process is supported by an audible and visual signal
- Peak load display (peak hold)
- Selectable measuring units: N, lbf, kgf

Technical data

- Measuring precision: 0,5 % of [Max]
- Maximum stroke length: 100 mm
- Maximum work zone: 100 mm
- Overall dimensions W×D×H
235×300×620 mm
- Net weight approx. 22 kg

STANDARD

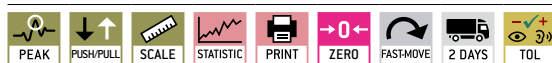

OPTION



Model	Measuring range [Max] N	Readout [d] N	Price excl. of VAT ex works €	Option	
				Factory calibration certificate	
				KERN	€
SAUTER SD 50N100	50	0,01	2520,-	961-2610	178,-
SD 100N100	100	0,02	2520,-	961-2610	178,-
SD 200N100*	200	0,05	2330,-	961-2610	178,-
SD 500N100	500	0,1	2520,-	961-2610	178,-

 * ONLY WHILE STOCKS LAST!

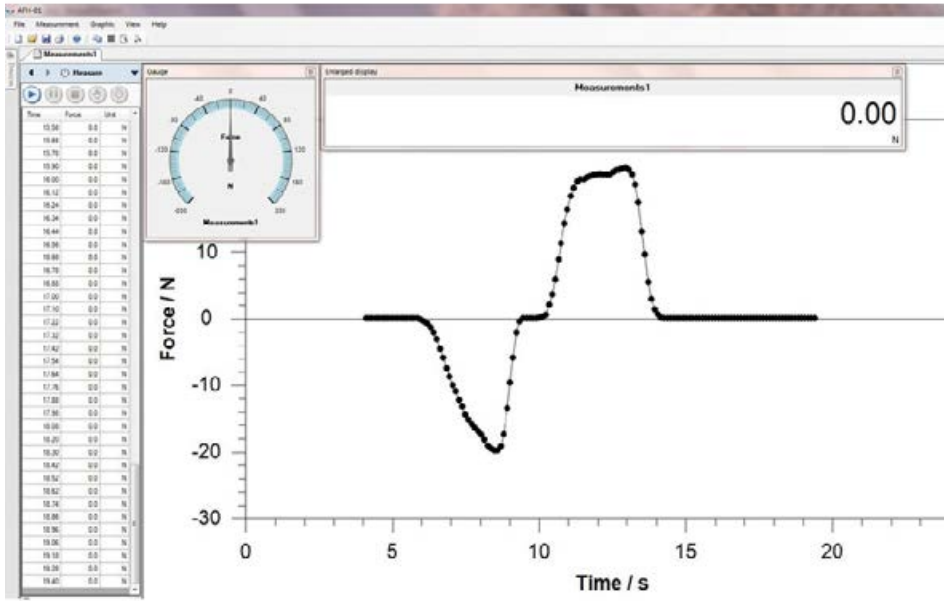

Time	Force	Unit	Device	DeviceName	DeviceType	DeviceModel	DataTime
1	0.00	N	FH 200	NaN	NaN	NaN	2011-11-09T11:51:29
2	0.00	N	FH 200	NaN	NaN	NaN	2011-11-09T11:51:29
3	0.00	N	FH 200	NaN	NaN	NaN	2011-11-09T11:51:29
4	0.00	N	FH 200	NaN	NaN	NaN	2011-11-09T11:51:29
5	0.00	N	FH 200	NaN	NaN	NaN	2011-11-09T11:51:29
6	0.00	N	FH 200	NaN	NaN	NaN	2011-11-09T11:51:29
7	0.00	N	FH 200	NaN	NaN	NaN	2011-11-09T11:51:29
8	0.00	N	FH 200	NaN	NaN	NaN	2011-11-09T11:51:29
9	0.00	N	FH 200	NaN	NaN	NaN	2011-11-09T11:51:29
10	0.00	N	FH 200	NaN	NaN	NaN	2011-11-09T11:51:29
11	0.00	N	FH 200	NaN	NaN	NaN	2011-11-09T11:51:29
12	0.00	N	FH 200	NaN	NaN	NaN	2011-11-09T11:51:29
13	0.00	N	FH 200	NaN	NaN	NaN	2011-11-09T11:51:29
14	0.00	N	FH 200	NaN	NaN	NaN	2011-11-09T11:51:29
15	0.00	N	FH 200	NaN	NaN	NaN	2011-11-09T11:51:29
16	0.00	N	FH 200	NaN	NaN	NaN	2011-11-09T11:51:29
17	0.00	N	FH 200	NaN	NaN	NaN	2011-11-09T11:51:29
18	0.00	N	FH 200	NaN	NaN	NaN	2011-11-09T11:51:29
19	0.00	N	FH 200	NaN	NaN	NaN	2011-11-09T11:51:29
20	0.00	N	FH 200	NaN	NaN	NaN	2011-11-09T11:51:29
21	0.00	N	FH 200	NaN	NaN	NaN	2011-11-09T11:51:29
22	0.00	N	FH 200	NaN	NaN	NaN	2011-11-09T11:51:29
23	0.00	N	FH 200	NaN	NaN	NaN	2011-11-09T11:51:29
24	0.00	N	FH 200	NaN	NaN	NaN	2011-11-09T11:51:29
25	0.00	N	FH 200	NaN	NaN	NaN	2011-11-09T11:51:29
26	0.00	N	FH 200	NaN	NaN	NaN	2011-11-09T11:51:29
27	0.00	N	FH 200	NaN	NaN	NaN	2011-11-09T11:51:29
28	0.00	N	FH 200	NaN	NaN	NaN	2011-11-09T11:51:29
29	0.00	N	FH 200	NaN	NaN	NaN	2011-11-09T11:51:29
30	0.00	N	FH 200	NaN	NaN	NaN	2011-11-09T11:51:29
31	0.00	N	FH 200	NaN	NaN	NaN	2011-11-09T11:51:29
32	0.00	N	FH 200	NaN	NaN	NaN	2011-11-09T11:51:29
33	0.00	N	FH 200	NaN	NaN	NaN	2011-11-09T11:51:29
34	0.00	N	FH 200	NaN	NaN	NaN	2011-11-09T11:51:29
35	0.00	N	FH 200	NaN	NaN	NaN	2011-11-09T11:51:29
36	0.00	N	FH 200	NaN	NaN	NaN	2011-11-09T11:51:29

01



Data transfer software for force-time-measurements

Features

- Force measurements can be conducted over a very short period, i.e. seconds
- A high speed data transfer to a PC is possible (with a transfer of up to 20 data sets per second) when combining the AFH FAST with SAUTER FH, FC or FL
- AFH FAST shows the results in a Force-Time-Graph and can export the data to Microsoft Excel®
- Compatible with the following operating systems: Microsoft Windows 10®

Technical data

- Data recording rate approx. 20 measurements per second with SAUTER FH, FC and FL
- The following interface cables are supplied with the product:
 - RS-232 for SAUTER FH (FH-A01)
 - USB for SAUTER FL (FL-A01)

Accessories

- **1** RS-232/USB adapter, to connect peripheral devices with USB connection, SAUTER AFH 12, **€ 95,-**
- RS-232/Ethernet adapter for connection to an IP-based Ethernet network, KERN YKI-01, **€ 345,-**

STANDARD



Model	Price excl. of VAT ex works €
SAUTER	
AFH FAST	115,-

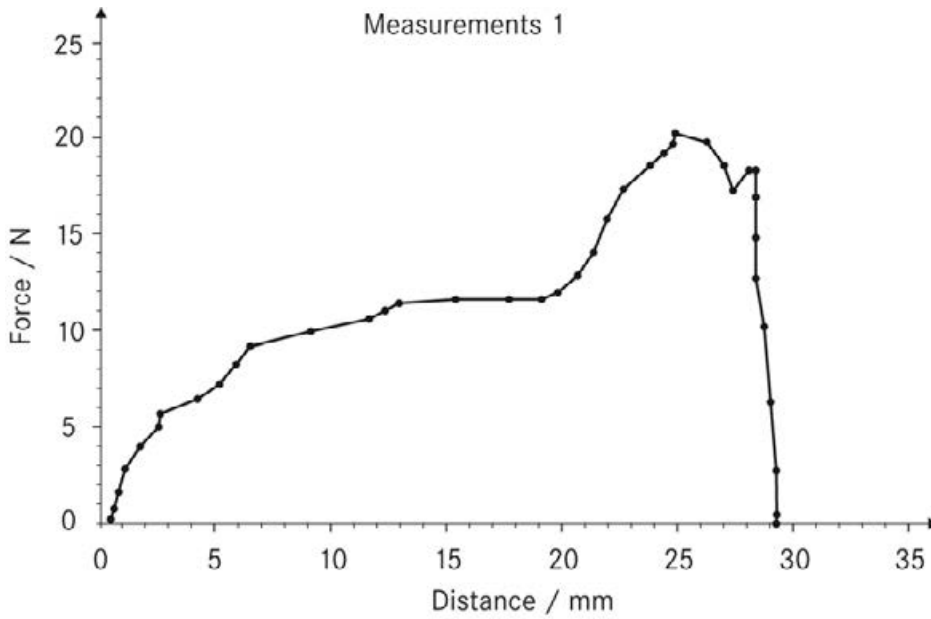

Data transfer software for force-displacement-measurements

Features

- AFH FD/AFH LD software is designed for all applications that require the measurement of forces, depending on the displacement. Typically these are force progression graphs in penetration tests or pullout tests
- The program simultaneously requests the measurements from a force measuring device, e.g. SAUTER FH, as well as a length measuring device, e.g. SAUTER LB or SAUTER LD 1, 2
- The measurements from both instruments are transferred continuously to the PC, synchronised by the AFH FD/AFH LD software and exported in the form of a graphic, as well as free data format for simple processing in Microsoft Excel®
- The software AFH FD/AFH LD is compatible with all instruments of series SAUTER FC, FH, FL, FS
- These measuring instruments are usually used with SAUTER test stands, in particular those from the SAUTER TVM-N and TVS range. However, it is also possible to use them with mechanical testing machines

- Further analysis functions:
 - Extension of the test object
 - Tensile and compressive force
 - Endurance testing
 - Archiving the recorded data
 - Scope of delivery for SAUTER AFH FD/AFH LD:
 - Software AFH FD/AFH LD on DVD
 - User manual
 - RS 232 interface cable for FH (FH-A01)
 - USB interface cable for FL (FL-A01)
 - AFH FD: RS 232 interface cable for LB (LB-A01)
 - Compatible with following operating systems: Microsoft Windows 10®
 - Order example for a complete test system:
 - FH 5K (Digital force gauge)
 - LB 300-2 (Digital length measuring device)
 - AFH FD (Force-distance evaluation software)
 - TVM 5000N230N* (Test stand)
 - LB-A02* (Mounting LB on test stands)
 - 2 x AFH 12 (RS-232/USB adapter)
 - AC 04* (Test object holder)
 - 963-163* (Force calibration)
 - 961-150* (Length calibration)
- * not necessarily required for operating the AFH FD software

SAUTER AFH LD

- Force-displacement software, but only in combination with a length measuring device of SAUTER LD series

Technical data

- Data recording rate max. 3 Hz (specially in combination with SAUTER FH and SAUTER LB)
- Data recording rate max. 25 Hz (in combination with SAUTER LD, dependent on measuring instrument)

Accessories

- Interface cable RS-232 for SAUTER FH: SAUTER FH-A01, € 50,- for SAUTER LB: SAUTER LB-A01, € 390,-
- RS-232/USB adapter, to connect peripheral devices with USB connection, SAUTER AFH 12, € 95,-

STANDARD



Model	Price excl. of VAT ex works €
SAUTER	
AFH FD	710,-
AFH LD	270,-

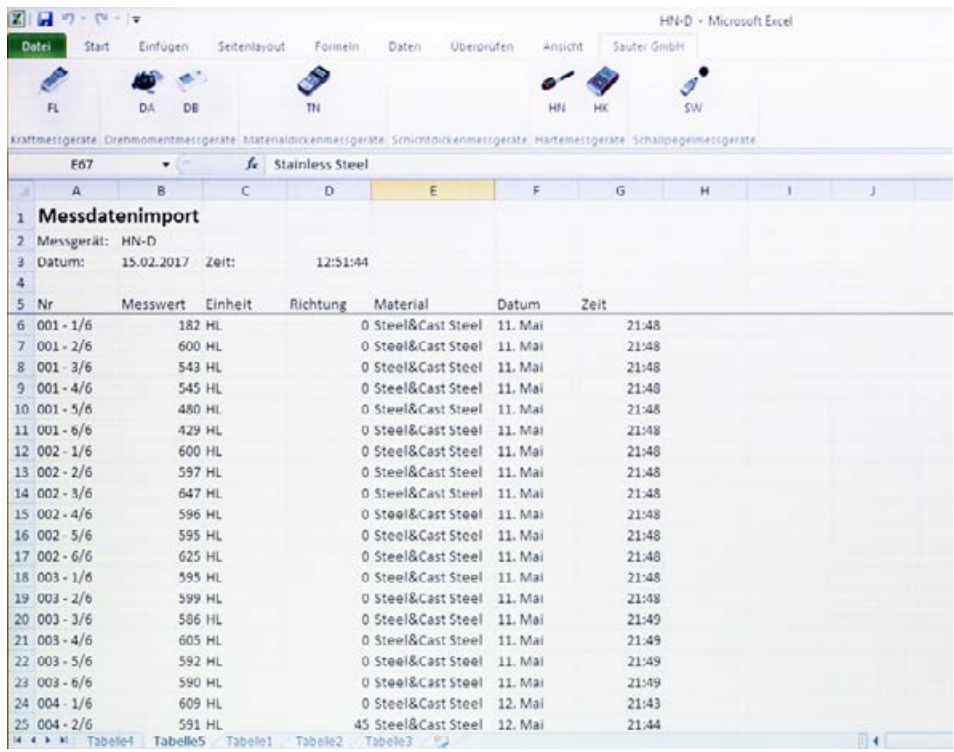

Plug-In for data transfer of measuring data from the measuring instrument and transfer to a PC, e.g. in Microsoft Excel®

Features

- Ideal for transferring measuring data from the internal data memory of the measuring instrument to Microsoft Excel®
- Solution: SAUTER AFI-2.0 plug-in for Microsoft Excel®. By doing this, an installation and learning yet another software can be avoided
- Compatible with Microsoft Excel® 2010 et seq.
- Easy handling: The measuring instrument is connected to the PC. At the push of a button, the SAUTER AFI-2.0 plug-in scans all the existing serial interfaces on the PC, finds the relevant measuring instrument and then reads the measuring data memory

Technical data

- Scope of supply:
 - SAUTER AFI plug-in
 - USB/PC connection cable SAUTER FL-A01
- Suitable for the following ranges: SAUTER FL, FS, DA, DB, HN-D, HK-D, HK-DB, SW

Accessories

- RS-232/Ethernet adapter for connection to an IP-based Ethernet network, KERN YKI-01, **€ 345,-**
- USB/PC connection cable (USB-A/USB mini), SAUTER FL-A01, **€ 50,-**

STANDARD	
Model	Price
	excl. of VAT
	ex works
SAUTER	€
AFI-2.0	95,-

For tension tests ≤ 500 N

 **Long clamp** **AC 17R**
for tension and rupture tests up to 500 N,
clamping width: 3 mm, thread: M6
€ 79,-
1 piece
AC 17
€ 135,-
2 pieces

 **Angle bracket** **AC 01R**
for tension and rupture tests up to 500 N
(e.g. for cable tests),
clamping width: 22 mm, thread: M6
€ 72,-
1 piece
AC 01
€ 138,-
2 pieces

 **Rope and thread clamp** **AC 10S***
for tension and rupture tests up to 500 N
thread: M6
€ 80,-
1 piece

 **Fine point clamp** **AC 14R**
for tension and rupture tests up to 500 N,
width 15 mm, clamping width: 4 mm,
thread: M6
€ 39,-
1 piece
AC 14
€ 66,-
2 pieces

 **Fine point clamp** **AC 22R**
for tension and rupture tests up to 500 N,
width 22 mm, clamping width: 4 mm,
thread: M6
€ 79,-
1 piece
AC 22
€ 138,-
2 pieces

 **Screw tension clamp** **AD 9001**
for 100 N for laboratory tensile force
measurements, incl. jaws with pyramid
grip, clamping width: 4 mm, thread: M6
Further jaws on request
PREMIUM

 **Screw tension clamp** **AD 9005**
for 400 N for laboratory tensile force
measurements, incl. jaws with pyramid
grip **1** with adapter structure for
AD-system, **2** with M6 thread,
clamping width: 8 mm
Further jaws on request
PREMIUM

For tension tests ≤ 5000 N

 **Flat jaw attachment** **AC 03R**
for tension tests up to 5 kN
(e.g. textile, paper etc.),
clamping width: 4 mm, thread: M6
€ 76,-
1 piece
AC 03
€ 151,-
2 pieces

 **Parallel jaw grip** **AC 12R**
for tension and rupture tests up to 5 kN,
clamping width: 5 mm, thread: M10
€ 50,-
1 piece
AC 12
€ 95,-
2 pieces

 **High capacity small clamp** **AC 16R***
for tension and rupture tests up to 5 kN,
clamping width: 5 mm, thread: M10
€ 79,-
1 piece
AC 16*
€ 151,-
2 pieces

 **2 wide jaw grip attachment** **AC 18R**
for tension and extraction tests up to
5 kN, jaw width 60 mm, clamping width:
33 mm, thread: M10
€ 85,-
1 piece
AC 18
€ 156,-
2 pieces

 **Rolling-clamp attachment** **AC 11R**
for tension and rupture tests up to 5 kN,
thread: M10
€ 80,-
1 piece

 **1-jaw-clamp attachment** **AC 13R***
for tension and rupture tests up to 5 kN,
clamping width: 3 mm, thread: M6
€ 55,-
1 piece
AC 13*
€ 104,-
2 pieces

 **Eccentric roll clamp** **AC 41***
in particular for cable tests up to 5 kN,
10×30 mm slotted hole, clamping width:
9 mm
€ 240,-
1 piece

 **Drum clamp** **AC 42***
typically for cable connector extraction
tests up to 5 kN, for test objects with
∅ from 1,5 mm up to 8 mm, thread: M10
€ 240,-
1 piece

 **Wedge tension clamp** **AD 9080**
up to 5 kN, for tensile force tests, due
to the wedge shape of the clamp the
specimen is clamped automatically with
increasing load, clamping width up to
10 mm, jaws with pyramid grip
Price on request
1 piece
PREMIUM

 **Rope and thread tension clamp** **AD 9120**
up to 1 kN, Suitable for wires up to a
diameter of 2 mm, belts up to 7 mm
width, incl. jaws with rubberised surface
Price on request
1 piece
PREMIUM

! *ONLY WHILE STOCKS LAST

For tension tests ≤ 5000 N



Rope and thread tension clamp
up to 5 kN, for clamping belts, ropes, wires, etc.
Suitable for wires up to a diameter of 5 mm, belts up to 8 mm. jaws with pyramid grip

AD 9121
Price on request
1 piece



Roller tension clamp
up to 1 kN, can clamp on one side and eccentrically. suitable for tensile force tests with belts or any other soft, flexible, flat material with a maximum sample thickness of 7 mm, incl. rollers with pyramid grip, the opposite clamping surface is smooth.
Suitable for test objects up to 50 mm width

AD 9205
Price on request
1 piece



Roller tension clamp
up to 5 kN, can clamp on one side and eccentrically. Suitable for tensile force tests with belts or any other soft, flexible, flat material with a maximum sample thickness of 7 mm, incl. rollers with pyramid grip, the opposite clamping surface is smooth.
Suitable for test objects up to 50 mm width

AD 9207
Price on request
1 piece



For tension tests > 5000 N



Belt tension clamp
up to 10 kN, open at one end, suitable for tensile force tests with belts or any other soft, flexible, flat materials with a maximum sample thickness of 2,5 mm a test object width up to 22 mm

AD 9250
Price on request
1 piece



Belt tension clamp
up to 20 kN, suitable for tensile force tests with belts or any other soft, flexible, flat materials with a maximum sample thickness of 2,5 mm a test object width up to 80 mm

AD 9255
Price on request
1 piece



Wedge tension clamp
up to 10kN, for tensile force tests, due to the wedge shape of the clamp the specimen is clamped automatically with increasing load, clamping width up to 10 mm, incl. jaws with pyramid grip
Further jaws on request

AD 9090



Wedge tension clamp
up to 20kN, for tensile force tests, due to the wedge shape of the clamp the specimen is clamped automatically with increasing load, clamping width up to 13 mm, incl. jaws with pyramid grip
Further jaws on request

AD 9095



Wedge tension clamp
up to 50kN, for tensile force tests, due to the wedge shape of the clamp the specimen is clamped automatically with increasing load, clamping width up to 13 mm, incl. jaws with pyramid grip
Further jaws on request

AD 9096



Tip

Have you not found the right fastener? We are happy to manufacture individual fastening options according to your specifications, for all details see page 17

For compression tests > 500 N

01



Concave force sensor **AC 45**
with optimised radius for the measurement particularly of arms and legs up to 1 kN, thread: M6
€ 135,-
1 piece



Flat square-shaped sensor **AC 46**
for lateral power sensing of back, chest or arm up to 1 kN, thread: M6
€ 90,-
1 piece



Round sensor **AC 47**
to measure particular muscle groups, such as, for example, the shoulder up to 1 kN, inner thread: M6
€ 95,-
1 piece



Pressure disc **AFH 06**
out of aluminium, thickness 10 mm, for compression tests up to 5 kN, diam. 110 mm, outer thread: M12
€ 60,-
1 piece



Pressure disc **AC 08R***
for compression tests up to 5 kN (e. g. plastics), \varnothing 49 mm, inner thread: M10
€ 49,-
1 piece

AC 08*
€ 95,-
2 pieces



Ball-shaped head made of nickel-plated steel **AC 02**
for compression and fracture tests up to 5 kN, (e.g. foam, glass), thread: M6/M10
Ball radius: 5mm/8mm
€ 65,-
1 piece each



Small 3-point bending device (steel) **AD 9300**
up to 10 kN, central scale 80-0-80 mm. Consisting of one support beam, two support brackets and a curved fin each with permanently fixed radii, radii on request.
Gap between the two support brackets 4-170 mm. Width of the brackets 30 mm
Price on request
1 piece

PREMIUM
★★★

For tension and compression tests



Threaded adapters **AFM 14**
made of steel for SAUTER force measuring devices, clamps and test stands, external thread 1: M6 external thread 2: M12
€ 18,-
1 piece

PREMIUM
★★★



Threaded adapters **AFM 05**
made of steel, for SAUTER force gauges, clamps and test stands, external thread: M10 internal thread: M6
€ 18,-
1 piece

PREMIUM
★★★



Threaded adapters **AFM 16**
made of steel, for SAUTER force gauges, clamps and test stands, external thread: M12 internal thread: M10
€ 18,-
1 piece

PREMIUM
★★★



Threaded adapters **AFM 22**
made of steel for SAUTER force gauges and clamps, external thread: M6 internal thread: M8
€ 18,-
1 piece

PREMIUM
★★★



Threaded adapters **AFM 07**
made of steel, for SAUTER force gauges, clamps and test stands, external thread: M10 internal thread: M6
€ 18,-
1 piece

PREMIUM
★★★

NEW



Grub screw **AFM 20**
made of steel for SAUTER clamps and test stands, external thread: M6
€ 18,-
1 piece

PREMIUM
★★★

NEW



Threaded adapters **AFM 23**
made of steel, for SAUTER force gauges, clamps and test stands, external thread: M10 internal thread: M8
€ 18,-
1 piece

PREMIUM
★★★

NEW

Numerous more adapters on request.

For tension tests ≤ 500 N



Standard small clamp

Opening width (inside the jaws): 0-7 mm, for tensile tests up to 500 N, thread M6. Overload protection: 150 % of [Max].

Easy handling without tools, the opening and closing of the jaws can be made with the rotary knob on the upper side. Presetting of the jaw opening via attached screws. Pretension due to built-in springs

AE 01
€ 145,-
1 piece



For tension tests ≤ 500 N



Cable removal clamp

Opening width (inside the jaws): 1,5-6 mm, for tensile tests up to 500 N, thread M6. Overload protection: 150 % of [Max].

Easy handling without tools, test item can simply be inserted into the appropriate recess and be tested

AE 06
€ 245,-
1 piece



01



Wide jaw clamp

Opening width (inside the jaws): 0-6 mm, for tensile tests up to 500 N, thread M6. Overload protection: 150 % of [Max].

Easy handling without tools, the opening and closing of the jaws can be made with the rotary knobs on the upper side

AE 02
€ 165,-
1 piece



Wedge tension clamp

Opening width (inside the jaws): 0-6 mm, for tensile tests up to 500 N, thread M6. Overload protection: 150 % of [Max].

Easy handling without tools, test item can simply be inserted into the open clamp. It closes automatically during a tensile test

AE 07
€ 260,-
1 piece



Belt tension clamps

Opening width (inside the jaws): 0-4 mm, for tensile tests up to 500 N, thread M6. Overload protection: 150 % of [Max].

Easy handling without tools, the opening and closing of the jaws can be made with the lever on the upper side

AE 03
€ 320,-
1 piece



For compression tests ≤ 5000 N



Stainless steel pressure disc

For compression tests up to 5 kN, ø 47 mm, internal thread M6, foam rubber attachment for sensitive surfaces included in scope of delivery

AE 08
€ 33,-
1 piece



Belt tension clamps

Opening width (inside the jaws): 0-6 mm, for tensile tests up to 500 N, thread M6. Overload protection: 150 % of [Max].

Easy handling without tools, the opening and closing of the jaws can be made with the lever on the upper side

AE 04
€ 245,-
1 piece



Rope and thread tension clamps

Opening width (inside the jaws): 0-5 mm, for tensile tests up to 500 N, thread M6. Overload protection: 150 % of [Max].

Easy handling without tools, test item can simply be wrapped around the screw and fastened via the clamping screw

AE 05
€ 65,-
1 piece





Quickly fittable universal screw tension clamp for tension and compression testing for a force range up to 500 N

Features

- High-quality screw tension clamp in the lower force range with an enormous flexibility for a fast adaptation to a wide variety of test objects
- Solid version for high clamp forces
- Flexible clamping width (width between the jaws) from 0-10 mm
- **1** Jaws with pyramid grip as standard, W×H 15×10 mm
- The modular construction enables a quick adaptation and cleaning of the clamp
- The threaded rods with hexagon socket allow the test objects to be securely clamped with standard tools and thus adapted to the user's own requirements and operating conditions, e.g. use with a test stand or measuring device, etc.
- Can be used with all SAUTER force measuring devices or test stand systems
- To fix the clamp on a force gauge, there is a M6 thread on the upper side of the clamp
- **2** Scope of supply: 1 clamp with 2 jaws with pyramid-shaped grip

Technical data

- For tension and compression testing up to 500 N
- Overload protection: 150 % of [Max]
- Overall dimensions W×D×H 51×41×15 mm
- Net weight approx. 0,10 kg

STANDARD



1 DAY

Model	Measuring range	Price excl. of VAT ex works €
SAUTER	[Max] N	
AE 500	500	195,-

Attachments



Standard attachments kit AC 43
for all force gauges FA, FH, FL, FC and FS, thread: M6
10-500 N
€ 61,-
6 items



Standard attachments kit AC 430
for force gauge FK, thread: M8
10-1000 N
€ 55,-
6 items



Tensiometer attachment FK-A01
optional for all FK models from FK 10 up to FK 250
€ 230,-
1 piece



Tensiometer attachment FK-A02
for high-capacity tensile strength tests up to FK 500 and FK 1K
€ 320,-
1 piece

Special solutions



Stainless steel handle bar AFH 04
with rubber grip for safe handling, AFH 04 suitable for FA, FH, FL, AFK 02 suitable for FK, FC and FS
€ 105,-
1 piece



Stainless steel handle bar AFH 05
with rubber grip for FH, FL with external sensor, thread: M12
€ 60,-
1 piece



Door tester AFH 03
Handle (length: 300 mm) and two round force receptor plates (ø 85 mm) as an option to FH 1K up to FH 5K for the safe testing of clamping forces (not approved to DIN 18650 or similar), up to 5 kN
€ 320,-
1 piece

Interface cables



RS-232/PC connection cable FH-A01
to connect models from the SAUTER FH range to a PC
€ 50,-
1 piece



RS-232/PC connection cable FL-A04
to connect models from the SAUTER FL, DA and DB range to a PC
€ 50,-
1 piece



USB/PC connection cable FL-A01
to connect models from the SAUTER FL, DA and DB range to a PC
€ 50,-
1 piece



RS-232/PC connection cable LB-A01
to connect models from the SAUTER LB range to a PC
€ 390,-
1 piece



RS-232/USB adapter AFH 12
to connect peripheral devices with USB interface, suitable for all balances and measuring instruments with RS 232 output, scope of supply: adapter, CD with driver
€ 95,-
1 piece



RS-232 connection cable FC-A01
to connect models from the SAUTER FC range
€ 50,-
1 piece



02 LENGTH MEASUREMENT

Measuring geometric characteristics is one of the most common tests when carrying out material testing. The most well-known tool is the calliper gauge or the micrometer gauge (micrometer).

In this area of measurement, SAUTER confines itself to integrated calliper gauges which can be used in combination with deforming material testing.

Very often, the issue of material testing relates to a force which is exerted in connection with a specific deformation, i.e. expansion or compression of the test item.

In these cases, the force must be measured or recorded in relation to the distance travelled by the test item during the test.

Integrated calliper gauges serve to capture this distance. They are typically fitted in test stands, machines or plant.

As a guide, the following has been assembled as a sample system for a typical material test stand:

- Length measuring device, e.g. LB 300-2
- Calibration length measuring device, e.g. 961-150
- Test stand, e.g. TVM-N
- Fitting to test stand, e.g. LB-A02
- Data transfer software, e.g. AFH FD
- Force gauges, e.g. FH
- Calibration Force gauges, e.g. 961-162
- 2× RS-232/USB adapter, e.g. AFH 12



Irmgard Russo
Product specialist
Length measurement

Tel. +49 7433 9933-208
info@sauter.eu

Quick-Finder

Readout	Measuring range	Model	Price	Page
[d] mm	[Max] mm	SAUTER	excl. VAT, ex works €	
0,01		LD	680,-	48
0,01	200	LB 200-2	1140,-	47
0,01	300	LB 300-2	1250,-	47
0,01	500	LB 500-2	1200,-	47



02

Distance measurement directly in machines or sites with RS-232 interface

Features

- Digital sliding calliper with a superior precision even at high operation speed
- Easy mounting to machine tools, conveyer, test stands e.g. SAUTER TVO-N, TVM-N etc.
- Zeroing, pre-added and pre-reduced length as well as switching the unit can be done manually
- Data interface RS-232 as standard
- Selectable measuring units: mm, inch

Technical data

- Overall dimensions W×D×H 350×42×30 mm
- Battery operation, batteries standard (3V CR2032)

Accessories

- RS-232/PC connection cable, SAUTER LB-A01, € 390,-
- Mounting the length measuring device LB onto a SAUTER test stand at the factory, SAUTER LB-A02, € 210,-

STANDARD				OPTION	
RS 232	ZERO	BATT	1 DAY	SOFTWARE	+4 DAYS

Model	Measuring range [Max] mm	Readout [d] mm	Direction of measurement	Price excl. of VAT ex works €	Option Factory calibration certificate	
					KERN	€
SAUTER LB 200-2	200	0,01	vertical	1140,-	961-150	150,-
SAUTER LB 300-2	300	0,01	vertical	1250,-	961-150	150,-
SAUTER LB 500-2	500	0,01	vertical	1200,-	-	-

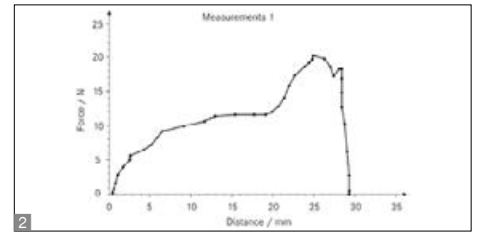

02



Linear potentiometer for length measurement for test stands TVO-S and TVS

Features

- This linear displacement sensor, with its lengthways coupling without rods, is specially constructed for accurate recording of distances
- By means of its compact design it is also suitable for high processing speeds
- 1 Can be used in all electrical SAUTER force testing systems with stepper motor, e.g. SAUTER TVO-S, THM-S, TVS, to determine distances e.g. within the scope of tensile or pressure testing
- Long service life: on average up to 100×10^6 cycles
- High data collection speed
- High-resolution linear position sensor with 65.000 points over the whole measuring range
- Data transfer box with 16-bit AD converter for high resolution and speed
- 2 You will need the SAUTER AFH LD software to read and evaluate data. This allows clear force-displacement analyses
- Scope of supply: Linear potentiometer, Data transfer box, mains adapter, USB cable

Technical data

- Measuring precision: 0,5 % of [Max]
- Reproducibility < 0,03 mm
- Overall dimensions W×D×H 449×68×38 mm
- Cable length USB approx. 1,5 m
- Cable length mains adapter approx. 1,2 m
- Net weight approx. 0,70 kg

Accessories

- Mounting the length measuring device LD onto a SAUTER test stand at the factory, SAUTER LD-A06, € 300,-
- 2 Data transfer software with graphical representation of the measuring process, Force-displacement only in combination with SAUTER LD, SAUTER AFH LD, € 270,-

STANDARD



Model	Measuring range	Readout	Direction of measurement	Price excl. of VAT ex works €
SAUTER LD	[Max] mm Length suitable for the travel of the selected test stand	[d] mm 0,01	vertical/horizontal	680,-

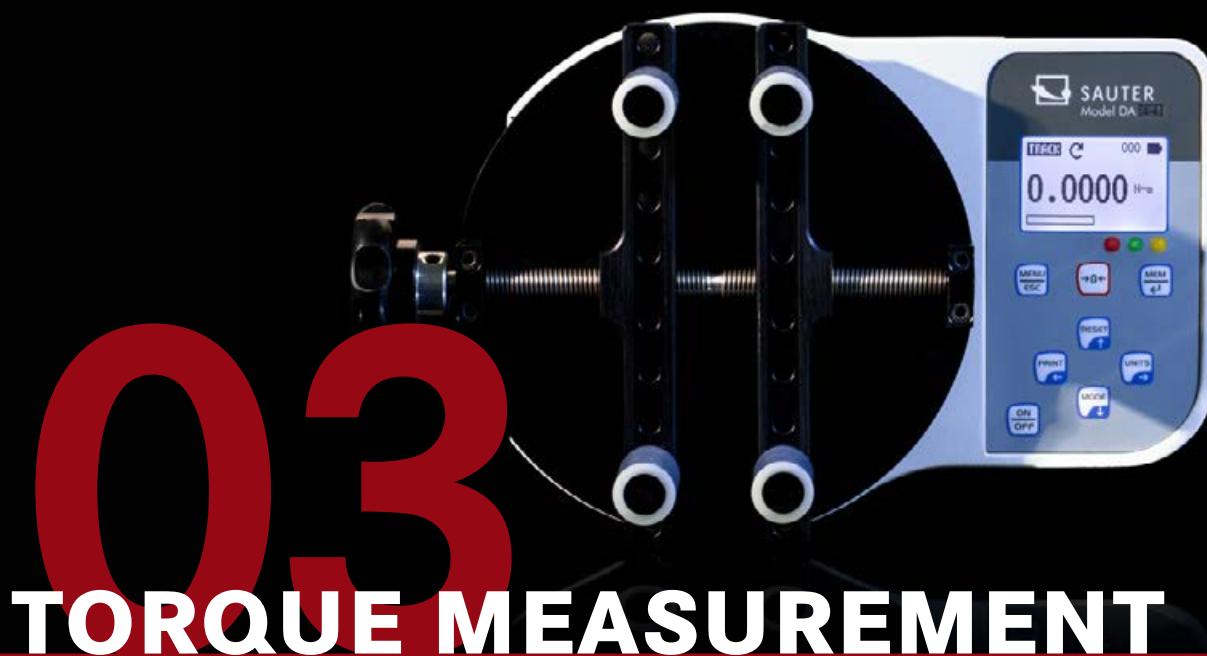

TORQUE MEASUREMENT

There is a fundamental differentiation here between the measurement of static and dynamic torques.

Dynamic torques measurement is typically carried out using torque sensors on test objects which are rotating – during the movement.

Static torques measurement, on the other hand, is always carried out when the item is at rest.

The SAUTER range includes static torques gauges for determining the torque expended when opening rotary or screw caps of any kind.

Further typical applications of static torque measuring devices are testing of assembly tools for screws and nuts, in particular torque keys and mechanical assembly tools such as cordless electric screw drivers.



Helga Biselli
Product specialist Torque measurement

Tel. +49 7433 9933-188
info@sauter.eu

Quick-Finder

Readout	Measuring range	Model	Price	Page
[d]	[Max]		excl. VAT,	
Nm	Nm	SAUTER	ex works	
			€	
0,0001	0,5	DB 0.5-4	1770,-	51
0,0002	1	DA 1-4	1980,-	50
0,0002	1	DB 1-4	1770,-	51
0,001	5	DA 5-3	1990,-	50
0,001	5	DB 5-3	1770,-	51
0,002	10	DA 10-3	1970,-	50
0,002	10	DB 10-3	1770,-	51
0,005	20	DB 20-3	2010,-	51
0,01	50	DB 50-2	2010,-	51
0,02	100	DB 100-2	2010,-	51
0,05	200	DB 200-2	2010,-	51
0,1	500	DB 500-2	2010,-	51



03



Comfortable testing of screw tops, e.g. bottles, jars, etc.

Features

- **1** Optimised for torque testing of bottles, jars and other packaging with screw tops with a minimum diameter of 15 mm and a maximum diameter of 160 mm, in the food industry and pharmaceutical industry, as well as in the manufacturing of cosmetics such as, for example, lipsticks, etc.
- **2** Quick pin system: The four bottle holders are pushed in, instead of being screwed in, to save time. This allows you to reconfigure quickly for other bottle sizes
- Metal housing for durable use in harsh environmental conditions
- **3** Capacity display: A bar lights up to show how much of the measuring range is still available
- **3** LCD graphics display with backlight
- Rubber feet with anti-slip feature
- Internal data memory saves up to 500 measurements. The memory contents can be transferred to the PC using optional software

- **4** Data interface USB and RS-232 included
- Peak-Hold function to capture the peak value or Track function for continuous display of measurement
- Can be used in both directions of rotation
- Measuring with tolerance range (limit-setting function): Upper and lower limiting can be programmed individually. The process is supported by an audible and visual signal
- AUTO-OFF function
- Scope of delivery: four bottle holders with rubber coating, sturdy carrying case

Technical data

- Selectable measuring units: Nm, lbf-in, kgf-cm, kgf-m, ft-lbf
- Measuring precision: $\pm 0,5\%$ of [Max]
- Usable measuring range: 5 - 100 % of [Max]
- Overload protection: 120 % of [Max]
- Rechargeable battery pack integrated, as standard, operating time up to 18 h without backlight, charging time approx. 14 h
- Overall dimensions WxDxH 260x160x60 mm
- Net weight approx. 3,0 kg

Accessories

- Plug-In for data transfer of measuring data from the measuring instrument and transfer to a PC, e.g. in Microsoft Excel®, SAUTER AFI-2.0, **€ 95,-**
- Data transfer software with graphic display of the measurement process, Force-time, SAUTER AFH FAST, **€ 115,-**

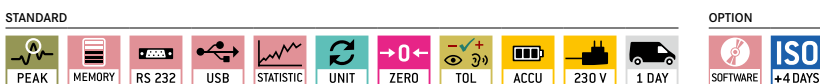

Model	Measuring range [Max] Nm	Readout [d] Nm	Diameter test object mm	Price excl. of VAT ex works €	Option Factory calibration certificate	
					KERN	€
SAUTER DA 1-4	1	0,0002	165	1980,-	961-120	210,-
DA 5-3	5	0,001	165	1990,-	961-120	210,-
DA 10-3	10	0,002	165	1970,-	961-120	210,-



03

Convenient way to test the torque of tools

Features

- **1** Particularly suitable for testing torque wrenches, electric hand screwdrivers and cordless screwdrivers
- **2** Torque pick-up system for dynamic testing of electric screwdrivers (from SAUTER DB 0.5-4 to DB 50-2)
- Metal housing for durable use in harsh environmental conditions
- Capacity display: A bar lights up to show how much of the measuring range is still available
- LCD graphics display with backlight
- Rubber feet with anti-slip feature (from SAUTER DB 0.5-4 to DB 10-3)
- **3** Stable mounting plate for solid fixation (from SAUTER DB 20-3 to DB 500-2)
- Data interface USB and RS-232 included

- Internal data memory saves up to 500 measurements. The memory contents can be transferred to the PC using optional software
- Peak-Hold function to capture the peak value or Track function for continuous display of measurement
- Can be used in both directions of rotation
- Measuring with tolerance range (limit-setting function): Upper and lower limiting can be programmed individually. The process is supported by an audible and visual signal
- AUTO-OFF function
- Scope of delivery: Torque pick-up, sturdy carry case, mounting plate (for models with [Max] ≥ 20 Nm)

Technical data

- Backlit LCD graphics display
- Selectable measuring units: Nm, lbf-in, kgf-cm, kgf-m, ft-lbf
- Measuring precision: ± 0,5 % of [Max]
- Usable measuring range: 5 - 100 % of [Max]
- Overload protection: 120 % of [Max]
- Rechargeable battery pack integrated, as standard, operating time up to 18 h without backlight, charging time approx. 14 h
- Overall dimensions W×D×H 200×100×50 mm
- Net weight approx. 2,2 kg

Accessories

- Plug-In for data transfer of measuring data from the measuring instrument and transfer to a PC, e.g. in Microsoft Excel®, SAUTER AFI-2.0, **€ 95,-**
- Data transfer software with graphic display of the measurement process, Force-time, SAUTER AFH FAST, **€ 115,-**



Model	Measuring range [Max] Nm	Readout [d] Nm	Tool fitting mm/Inch	Price excl. of VAT ex works €	Option Factory calibration certificate	
					KERN	€
SAUTER DB 0.5-4	0,5	0,0001	20 mm & 3/8"	1770,-	961-120	210,-
DB 1-4	1	0,0002	20 mm & 3/8"	1770,-	961-120	210,-
DB 5-3	5	0,001	20 mm & 3/8"	1770,-	961-120	210,-
DB 10-3	10	0,002	20 mm & 3/8"	1770,-	961-120	210,-
DB 20-3	20	0,005	20 mm & 3/8"	2010,-	961-120	210,-
DB 50-2	50	0,01	20 mm & 3/8"	2010,-	961-120	210,-
DB 100-2	100	0,02	3/8"	2010,-	961-120	210,-
DB 200-2	200	0,05	1/2"	2010,-	961-120	210,-
DB 500-2	500	0,1	3/4"	2010,-	961-120	210,-



04 COATING THICKNESS MEASUREMENT

Measurement of coating thicknesses is known from, for example, the paint measurement for coating thickness at cars. In fact, these measurements are used much more widely in industrial applications. This is where the thickness of the surface finish is measured, such as galvanisation, zinc coating etc. or also lacquers.

Fundamentally there are two measuring principles for determining coating thickness:



Typ F: Non-magnetic coatings on magnetic metals, such as iron or steel (magnetic induction principle). Here are some sample material combinations:

- 1) [chrome, copper, rubber, lacquer] on
- 2) [steel, iron, alloys, magnetic stainless steel]



Irmgard Russo

Product specialist

Coating thickness measurement

Tel. +49 7433 9933-208

info@sauter.eu



Typ N: Coatings on non-magnetic metals, such as aluminium (eddy current principle). Here are some sample material combinations:

- 3) [lacquer, paints, enamel, chrome, plastics] on
- 4) [aluminium, brass, sheet metal, copper, zinc, bronze]



Typ FN: All coatings as for type F and N on all metals as for type F and N (combination of magnetic induction and eddy current principle)

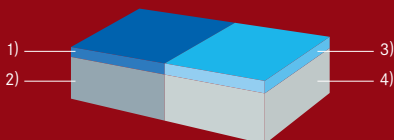

Quick-Finder

Readout	Measuring range	Model	Price	Page
[d]	[Max]	SAUTER	excl. VAT, ex works €	
µm	µm			
0,1 1	100 1000	TB 1000-0.1F	360,-	53
0,1 1	100 1000	TB 1000-0.1FN	455,-	53
0,1 1	100 2000	TB 2000-0.1F	325,-	53
0,1 1	100 1250	TC 1250-0.1F	410,-	54
0,1 1	100 1250	TC 1250-0.1FN	520,-	54
0,1 1	100 1250	TC 1250-0.1FN-CAR	530,-	54
0,1 1	100 1250	TC 1250-0.1N	435,-	54
0,1 1	100 1250	TE 1250-0.1F	410,-	55
0,1 1	100 1250	TE 1250-0.1FN	520,-	55
0,1 1	100 1250	TE 1250-0.1N	450,-	55
0,1 1	100 1250	TF 1250-0.1FN	600,-	56
0,1 1	100 1250	TG 1250-0.1FN	600,-	56



Practical measuring device for measuring the thickness of layers for daily use

Features

- External sensor for difficult-to-access measuring points
- Base plate and calibration foils included
- **1** Delivered in a robust carrying case
- Offset-Accur: This function allows you to adjust the instrument precisely on the locally measured range by a two-point calibration. This results in a superior accuracy of 1 % (or less) of the measured value
- Selectable measuring units: μm , inch (mil)
- Auto-Power-Off
- SAUTER TB 2000-0.1F: Specifically designed for the automobile industry, Precision: Standard 3 % of measured value
- Type F: Non-magnetic coatings on iron and steel
- Type N: Coatings on non-magnetic metals

Technical data

- Measuring precision:
 - Standard: 3 % of measured value
 - Offset-Accur: 1 % of measured value
- Smallest sample surface (radius)
 - Type F
 - Convex: 1,5 mm
 - Flat: 6 mm
 - Concave: 25 mm
 - Type N
 - Convex: 3 mm
 - Flat: 6 mm
 - Concave: 50 mm
- Minimum thickness of base material: 300 μm
- Overall dimensions WxDxH 161x69x32 mm
- Battery operation, batteries standard (4x1.5 V AA)
- Net weight approx. 0,75 kg

Accessories

- **2** Calibration foils for increased measuring accuracy (covers the range from 20 up to 2000 μm , with < 3 % tolerance), SAUTER ATB-US07, **€ 115,-**
- **3** External sensor, Type F, SAUTER ATE 01, **€ 116,-**
- **4** External sensor, Type N, SAUTER ATE 02, **€ 125,-**



Model	Measuring range [Max] μm	Readout [d] μm	Test object	Price excl. of VAT ex works €	Option Factory calibration certificate	
					KERN	€
SAUTER TB 1000-0.1F	100 1000	0,1 1	Type F	360,-	961-110	150,-
SAUTER TB 2000-0.1F	100 2000	0,1 1	Type F	325,-	961-110	150,-
SAUTER TB 1000-0.1FN	100 1000	0,1 1	Combination instrument Type F/Type N	455,-	961-112	210,-



04

Robust measuring device for layer thickness – compact and easy to use

Features

- Ergonomic design for easy handling
- Data interface RS-232 as standard
- Base plate and calibration foils included
- **1** Delivered in a robust carrying case
- Offset-Accur: This function allows you to adjust the instrument precisely on the locally measured range by a two-point calibration. This results in a superior accuracy of 1 % (or less) of the measured value
- Selectable measuring units: μm , inch (mil)
- **2** SAUTER TC 1250-0.1FN-CAR
- Specifically designed for the automobile industry
- Automatic recognition of measuring mode (F or N): “point and shoot”
- Simple and convenient 1-key operation

Technical data

- Measuring precision:
 - Standard: 3 % of measured value or $\pm 2,5 \mu\text{m}$
 - Offset-Accur: 1 % of measured value or $\pm 1 \mu\text{m}$
- Smallest sample surface (radius)
 - Type F
 - Convex: 1,5 mm
 - Flat: 6 mm
 - Concave: 25 mm
 - Type N
 - Convex: 3 mm
 - Flat: 6 mm
 - Concave: 50 mm
- Minimum thickness of base material: 300 μm
- Overall dimensions WxDxH 131x65x28 mm
- Battery operation, batteries standard (4x1.5 V AAA)
- Net weight approx. 0,10 kg

Accessories

- Data transfer software, interface cable included, SAUTER ATC-01, **€ 100,-**
- Calibration foils for increased measuring accuracy (covers the range from 20 up to 2000 μm , with < 3 % tolerance), SAUTER ATB-US07, **€ 115,-**

STANDARD

CAL BLOCK FOCUS RS 232 ZERO BATT 1 DAY

OPTION

SOFTWARE +4 DAYS ISO

Model	Measuring range [Max] μm	Readout [d] μm	Test object	Price excl. of VAT ex works €	Option Factory calibration certificate	
					KERN	€
SAUTER TC 1250-0.1F	100 1250	0,1 1	Non-magnetic coatings on iron, steel, Type F	410,-	961-110	150,-
TC 1250-0.1N*	100 1250	0,1 1	Coatings on non-magnetic metals, Type N	435,-	961-110	150,-
TC 1250-0.1FN	100 1250	0,1 1	Combination instrument Type F/Type N	520,-	961-112	210,-
TC 1250-0.1FN-CAR	100 1250	0,1 1	Combination instrument Type F/Type N	530,-	961-112	210,-



Ergonomic design and external sensor for highest ease of use

Features

- External sensor for difficult-to-access measuring points
- Data interface RS-232 as standard
- Base plate and calibration foils included
- **1** Delivered in a robust carrying case
- Offset-Accur: This function allows you to adjust the instrument precisely on the locally measured range by a two-point calibration. This results in a superior accuracy of 1 % (or less) of the measured value
- Selectable measuring units: μm , inch (mil)
- Auto-Power-Off

Technical data

- Measuring precision:
 - Standard: 3 % of measured value or $\pm 2,5 \mu\text{m}$
 - Offset-Accur: 1 % of measured value or $\pm 1 \mu\text{m}$
- Smallest sample surface (radius)
 - Type F
 - Convex: 1,5 mm
 - Flat: 1,5 mm
 - Concave: 25 mm
 - Type N
 - Convex: 3 mm
 - Flat: 5 mm
 - Concave: 50 mm
- Minimum thickness of base material: 300 μm
- Overall dimensions WxDxH 131x65x28 mm
- Battery operation, batteries standard (4x1.5 V AAA)
- Net weight approx. 0,10 kg

Accessories

- Data transfer software, interface cable included, SAUTER ATC-01, **€ 100,-**
- Calibration foils for increased measuring accuracy (covers the range from 20 up to 2000 μm , with < 3 % tolerance), SAUTER ATB-US07, **€ 115,-**
- **2** External sensor, Type F, SAUTER ATE 01, **€ 116,-**
- **3** External sensor, Type N, SAUTER ATE 02, **€ 125,-**

STANDARD						OPTION	

Model	Measuring range [Max] μm	Readout [d] μm	Test object	Price excl. of VAT ex works €	Option Factory calibration certificate	
					KERN	€
SAUTER TE 1250-0.1F	100 1250	0,1 1	Non-magnetic coatings on iron, steel, Type F	410,-	961-110	150,-
SAUTER TE 1250-0.1N	100 1250	0,1 1	Coatings on non-magnetic metals, Type N	450,-	961-110	150,-
SAUTER TE 1250-0.1FN	100 1250	0,1 1	Combination instrument Type F/Type N	520,-	961-112	210,-



04

Premium coating thickness gauge for paint coating, lacquer coating etc.

Features

- **1** LCD display, backlit, display of all information at a glance
- Offset-Accur: This function allows you to adjust the instrument precisely on the locally measured range by a two-point calibration. This results in a superior accuracy of 1 % (or less) of the measured value
- Scan mode for continuous measurement or single point measuring mode
- Mini Statistics Kit: displays the measured result, the average value and the max and the min value
- Internal data memory for up to 99 values
- Selectable measuring units: μm , inch (mil)
- Base plate and calibration foils included
- Data interface RS-232 as standard
- Delivered in a robust carrying case

SAUTER TG

- External sensor for difficult-to-access measuring points

Technical data

- Measuring precision:
 - Standard: 3 % of measured value or $\pm 2,5 \mu\text{m}$
 - Offset-Accur: 1 % of measured value or $\pm 1 \mu\text{m}$
- Minimum thickness of base material: $300 \mu\text{m}$
- Overall dimensions WxDxH 126x65x35 mm
- Battery operation, batteries standard (2x1.5 V AAA)
- Net weight approx. 0,10 kg

Accessories

- Data transfer software, interface cable included, SAUTER ATC-01, **€ 100,-**
- Calibration foils for increased measuring accuracy (covers the range from 20 up to $2000 \mu\text{m}$, with $< 3 \%$ tolerance), SAUTER ATB-US07, **€ 115,-**
- SAUTER TG: External sensor, Type FN, SAUTER ATG 01, **€ 145,-**

STANDARD

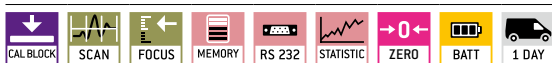

OPTION



Model	Measuring range [Max] μm	Readout [d] μm	Test object	Smallest sample surface (radius) mm	Price excl. of VAT ex works €	Option	
						Factory calibration certificate	
						KERN	€
TF 1250-0.1FN	100 1250	0,1 1	Combination instrument Type F/Type N	F: Convex: 1,5/ Concave: 25	600,-	961-112	210,-
TG 1250-0.1FN	100 1250	0,1 1	Combination instrument Type F/Type N	N: Convex: 3/ Concave: 50	600,-	961-112	210,-



05 MATERIAL THICKNESS MEASUREMENT

In cases, when the walls of the item to be measured are not accessible for traditional calliper gauges, the ultrasonic measuring equipment can be used.

This measurement is based on the following principle: Ultrasonic waves are directed onto one side of the material to be measured. They move with a defined speed through the material and are reflected on the other side. The measuring device measures the time required to do this and with this, calculates the thickness of the material.

In this way the wall thickness of, for example, ship's hulls, pipes, tanks and components in sites or machines can be determined.

Ultrasonic measuring equipment can be used to measure all hard and homogeneous materials, such as metal, glass and hard plastics. This method can not be used to measure materials as, e.g. concrete, asphalt, teflon or wood.



Andreas Vossler
Product specialist
Material thickness measurement

Tel. +49 7433 9933-243
info@sauter.eu

Quick-Finder

Readout [d] mm	Measuring range [Max] mm	Model SAUTER	Price excl. VAT, ex works €	Page
0,01	80	TN 80-0.01US	700,-	61
0,01	230	TN 230-0.01US	700,-	61
0,01	80	TN GOLD 80	770,-	60
0,01	300	TN 300-0.01US	800,-	61
0,01	600	TN 30-0.01EE	980,-	62
0,01	600	TN 60-0.01EE	1340,-	62
0,01	80	TU 80-0.01US	1310,-	63
0,01	230	TU 230-0.01US	1310,-	63
0,01	300	TU 300-0.01US	1410,-	63
0,01	600	TO 100-0.01EE	1490,-	64
0,1	200	TB 200-0.1US-RED	345,-	58
0,1	200	TB 200-0.1US	405,-	58
0,1	225	TD 225-0.1US	485,-	59
0,1	80	TN 80-0.1US	630,-	61
0,1	230	TN 230-0.1US	630,-	61
0,1	300	TN 300-0.1US	740,-	61



05 Reliable material thickness gauge for daily use

Features

- External sensor for difficult-to-access measuring points
- Base plate for adjustment included
- Auto-Power-Off
- Selectable measuring units: mm, inch
- TB 200-0.1US-RED: Can only analyse these materials: cast iron, aluminium, copper, brass, zinc, quartz glass, polyethylene, PVC, grey cast iron, nodular cast iron, steel
- Scope of delivery: Operating instructions, batteries and external measuring head (ø 8 mm)
- **1** Delivered in a robust carrying case

Technical data

- Measuring precision: 0,5 % of [Max]
- Overall dimensions WxDxH 161x69x32 mm
- Battery operation, batteries standard (4x1.5 V AA)
- Net weight approx. 0,30 kg

Accessories

- External sensor, 5 MHz, ø 6 mm, for thin test materials: measuring range (steel) up to approx. 80 mm, SAUTER ATB-US01, **€ 215,-**
- External sensor, 5 MHz, ø 12 mm, for hot test materials: Measuring range (steel) 3-200 mm at temperatures of up to 300 °C, SAUTER ATB-US02, **€ 270,-**
- External sensor, 5 MHz, ø 8 mm, SAUTER ATB-US06, **€ 110,-**
- External sensor, 5 MHz, ø 10 mm, SAUTER ATU-US09, **€ 120,-**
- Ultrasound contact gel, refill pack, approx. 70 ml, SAUTER ATB-US03, **€ 35,-**

STANDARD				OPTION

Model	Measuring range	Readout	Sensor	Sound velocity	Price excl. of VAT ex works €	Option Factory calibration certificate	
						KERN	€
SAUTER TB 200-0.1US	[Max] mm 1,5-200	[d] mm 0,1	5 MHz ø 8 mm	m/sec 500-9000	405,-	961-113	150,-
TB 200-0.1US-RED	1,5-200	0,1	5 MHz ø 8 mm	500-9000	345,-	961-113	150,-



Compact pocket-sized material thickness gauge

05

Features

- External sensor for difficult-to-access measuring points
- Data interface RS-232, included
- AUTO-OFF function to preserve the battery
- Selectable measuring units: mm, inch
- Base plate for adjustment included
- Scope of delivery: Operating instructions, batteries and external measuring head (∅ 8 mm)
- **1** Delivered in a robust carrying case

Technical data

- Measuring precision: 0,5 % of [Max] + 0,1 mm
- Overall dimensions W×D×H 30×65×120 mm
- Battery operation, batteries standard (4×1.5 V AAA)
- Net weight approx. 0,20 kg

Accessories

- Data transfer software, interface cable included, SAUTER ATC-01, **€ 100,-**
- External sensor, 5 MHz, ∅ 6 mm, for thin test materials: measuring range (steel) up to approx. 80 mm, SAUTER ATB-US01, **€ 215,-**
- External sensor, 5 MHz, ∅ 12 mm, for hot test materials: Measuring range (steel) 3-200 mm at temperatures of up to 300°C, SAUTER ATB-US02, **€ 270,-**
- External sensor, 5 MHz, ∅ 8 mm, SAUTER ATB-US06, **€ 110,-**
- External sensor, 5 MHz, ∅ 10 mm, SAUTER ATU-US09, **€ 120,-**
- External sensor, 5 MHz, ∅ 10 mm, transducer at an angle of 90°, SAUTER ATU-US10, **€ 120,-**
- Ultrasound contact gel, refill pack, approx. 70 ml, SAUTER ATB-US03, **€ 35,-**

STANDARD				OPTION	

Model	Measuring range	Readout	Sensor	Sound velocity	Price excl. of VAT ex works	Option	
						Factory calibration	certificate
	[Max] mm	[d] mm		m/sec	€	KERN	€
SAUTER TD 225-0.1US	1,2-225	0,1	5 MHz ∅ 8 mm	500-9000 m/s	485,-	961-113	150,-

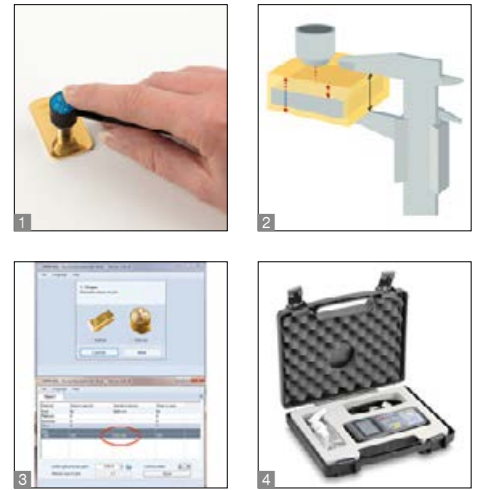

05

Ultrasonic measuring instrument for checking the authenticity of gold bars and coins

Features

- **1** You can use the TN-GOLD to determine whether gold or silver bars and coins are genuine or whether they contain a core of a different material
- The instrument measures the thickness of gold bars and gold coins using ultrasound
- **2** Process: Ultrasound waves are directed onto the test object using a sensor. The waves penetrate the test object, are then reflected from a surface opposite the object and then picked up again by the sensor. The measurement determined by this process will be compared with the material thickness as measured by a traditional calliper gauge. On the basis of the measurement given, false cores (Figure: grey) for example, those made of tungsten, lead, etc. can be easily identified, as the ultrasound reacts differently, compared with pure gold
- Selectable measuring units: mm, inch

- **3** SAUTER SSG software (included) can be used to calculate the sound velocity for various precious metal alloys. This makes it possible to determine whether coins or ingots contain false cores or whether they consist of one and the same material. Compatible with the following operating systems: Windows® 7/8/10
- Known additions in tested gold items – e.g. copper or silver – are compensated by the software
- In addition, the software determines the value of the gold item
- It is a test process which measures right through the whole bar or the whole coin without interference and thereby guarantees the highest level of certainty
- Internal memory for up to 20 files (with up to 100 values per file)
- Base plate for adjustment included
- **4** Delivered in a robust carrying case

Technical data

- Measuring precision: 0,5 % of [Max] ± 0,04 mm
- Overall dimensions W×D×H 150×74×32 mm
- Battery operation, batteries standard (2×1.5 V AA), AUTO-OFF function to preserve the battery
- Net weight approx. 0,25 kg

Accessories

- Data transfer software, interface cable included, SAUTER ATU-04, **€ 120,-**
- USB/PC connection cable (USB-A/USB mini), SAUTER FL-A01, **€ 50,-**
- External sensor, 7 MHz, ø 6 mm, for thin test materials: Measuring range 0,75–80 mm (steel), SAUTER ATU-US02, **€ 120,-**
- Ultrasound contact gel, refill pack, approx. 70 ml, SAUTER ATB-US03, **€ 35,-**



Model	Measuring range	Readout	Sensor	Sound velocity	Price excl. of VAT ex works €	Option Factory calibration certificate
SAUTER TN GOLD 80	[Max] mm 0,75-80	[d] mm 0,01	7 MHz ø 6 mm	m/sec 1000-9999	770,-	KERN 961-113 € 150,-



Portable measuring device for ultrasonic material thickness testing

05

Features

- External sensor
- Data interface USB standard (only for models with readout [d] = 0,01 mm)
- Scan mode (10 measurements per sec.) or single point measuring mode possible
- Internal memory for up to 20 files (with up to 100 values per file)
- Selectable measuring units: mm, inch
- **I** Delivered in a robust carrying case

Technical data

- Measuring precision: 0,5 % of [Max] ± 0,04 mm
- Overall dimensions W×D×H 150×74×32 mm
- Battery operation, batteries standard (2×1.5 V AA), AUTO-OFF function to preserve the battery
- Net weight approx. 0,25 kg

Accessories

- Data transfer software, interface cable included, SAUTER ATU-04, **€ 120,-**
- External sensor, 2,5 MHz, ø 14 mm, for thick samples, in particular cast iron with rough upper surfaces: Measuring range 3–300 mm (steel), SAUTER ATU-US01, **€ 235,-**
- External sensor, 7 MHz, ø 6 mm, for thin test materials: Measuring range 0,75–80 mm (steel), SAUTER ATU-US02, **€ 120,-**
- External sensor, 5 MHz, ø 10 mm, SAUTER ATU-US09, **€ 120,-**
- External sensor, 5 MHz, ø 10 mm, transducer at an angle of 90°, SAUTER ATU-US10, **€ 120,-**
- External sensor, 5 MHz, ø 12 mm, for hot test materials: Measuring range (steel) 3–200 ;mm at temperatures of up to 300°C, SAUTER ATB-US02, **€ 270,-**
- Ultrasound contact gel, refill pack, approx. 70 ml, SAUTER ATB-US03, **€ 35,-**

STANDARD						OPTION	
[d] < 0,01 mm							

Model	Measuring range	Readout	Sensor	Sound velocity	Price excl. of VAT ex works €	Option Factory calibration certificate	
						KERN	€
SAUTER	[Max] mm	[d] mm		m/sec			
TN 80-0.1US	0,75-80	0,1	7 MHz ø 6 mm	1000-9999	630,-	961-113	150,-
TN 230-0.1US	1,2-230	0,1	5 MHz ø 10 mm	1000-9999	630,-	961-113	150,-
TN 300-0.1US	3-300	0,1	2,5 MHz ø 14 mm	1000-9999	740,-	961-113	150,-
TN 80-0.01US	0,75-80	0,01	7 MHz ø 6 mm	1000-9999	700,-	961-113	150,-
TN 230-0.01US	1,2-230	0,01	5 MHz ø 10 mm	1000-9999	700,-	961-113	150,-
TN 300-0.01US	3-300	0,01	2,5 MHz ø 14 mm	1000-9999	800,-	961-113	150,-



05 Hand-held measuring device for ultrasonic material thickness testing in Echo-Echo principle

Features

- External sensor
- USB data interface, as standard
- Scan mode (10 measurements per sec.) or single point measuring mode possible
- Internal memory for up to 20 files (with up to 100 values per file)
- Selectable measuring units: mm, inch
- Two measuring modes to determine material thickness:
 - Pulse-Echo mode
 - Echo-Echo mode
- Echo-Echo measuring: Determining the actual thickness of materials irrespective of any coating which might be present. In this way, the wall thickness of pipes, for example, can be determined in a non-destructive manner, without having to remove the coating and the measurement can be shown on the display, with the adjustment for the coating thickness already taken into account
- Echo-Echo measurements are only possible with the measuring head included as part of the delivery (SAUTER ATU-US12, see accessories)

- Scope of delivery: Operating instructions, batteries, ultrasound contact gel and external measuring head (∅ 12 mm)
- Delivered in a robust carrying case

Technical data

- Measuring precision: 0,5 % of [Max] ± 0,04 mm
- Overall dimensions W×D×H 150×74×32 mm
- Battery operation, batteries standard (2×1.5 V AA), AUTO-OFF function to preserve the battery
- Net weight approx. 0,25 kg

Accessories

- Data transfer software, interface cable included, SAUTER ATU-04, **€ 120,-**
- External sensor, 5 MHz, ∅ 10 mm, for echo-echo measuring, SAUTER ATU-US12, **€ 345,-**
- Ultrasound contact gel, refill pack, approx. 70 ml, SAUTER ATB-US03, **€ 35,-**
- Note: All following Pulse-Echo sensors can only be used in Pulse-Echo mode, not in Echo-Echo mode
- External sensor, 2,5 MHz, ∅ 14 mm, for thick samples, in particular cast iron with rough upper surfaces: Measuring range 3–300 mm (steel), SAUTER ATU-US01, **€ 235,-**
- External sensor, 7 MHz, ∅ 6 mm, for thin test materials: Measuring range 0,75–80 mm (steel), SAUTER ATU-US02, **€ 120,-**
- External sensor, 5 MHz, ∅ 10 mm, SAUTER ATU-US09, **€ 120,-**
- External sensor, 5 MHz, ∅ 10 mm, transducer at an angle of 90°, SAUTER ATU-US10, **€ 120,-**

STANDARD						OPTION	

Model	Measuring range Echo-Echo	Measuring range Pulse-Echo	Readout [d] mm	Sensor	Sound velocity m/sec	Price	Option	
						excl. of VAT ex works €	Factory calibration certificate	
	mm	mm					KERN	€
SAUTER TN 30-0.01EE	3-30	0,65-600	0,01	5 MHz ∅ 10 mm	1000-9999	980,-	961-113	150,-
SAUTER TN 60-0.01EE	3-60	0,65-600	0,01	5 MHz ∅ 10 mm	1000-9999	1340,-	961-113	150,-



Premium ultrasonic thickness gauge

05

Features

- External sensor for difficult-to-access measuring points
- Base plate for adjustment included
- 1 USB data interface, as standard
- Scan mode (10 measurements per sec.) or single point measuring mode possible
- Internal memory for up to 20 files (with up to 100 values per file)
- Measuring with tolerance range (limit-setting function): Upper and lower limiting can be programmed individually. The process is supported by an audible and visual signal
- Selectable measuring units: mm, inch
- Robust metal housing
- 2 Delivered in a robust carrying case

Technical data

- Measuring precision: 0,5 % of [Max] ± 0,04 mm
- Overall dimensions WxDxH 132x76x32 mm
- Battery operation, batteries standard (2x1.5 V AA)
- Net weight approx. 0,35 kg

Accessories

- Software, interface cable included, SAUTER ATU-04TU, € 120,-
- External sensor, 2,5 MHz, ø 14 mm, for thick samples, in particular cast iron with rough upper surfaces: Measuring range 3–300 mm (steel), SAUTER ATU-US01, € 235,-
- External sensor, 7 MHz, ø 6 mm, for thin test materials: Measuring range 0,75–80 mm (steel), SAUTER ATU-US02, € 120,-
- External sensor, 5 MHz, ø 12 mm, for hot test materials: Measuring range (steel) 3–200 mm at temperatures of up to 300 °C, SAUTER ATB-US02, € 270,-
- External sensor, 5 MHz, ø 10 mm, SAUTER ATU-US09, € 120,-
- External sensor, 5 MHz, ø 10 mm, transducer at an angle of 90°, SAUTER ATU-US10, € 120,-
- Ultrasound contact gel, refill pack, approx. 70 ml, SAUTER ATB-US03, € 35,-

STANDARD

CALBLOCK MEMORY USB TOL ZERO BATT 1 DAY

OPTION

SOFTWARE ISO +4 DAYS

Model	Measuring range	Readout	Sensor	Sound velocity	Price excl. of VAT ex works €	Option	
						Factory calibration certificate	
	[Min] mm	[d] mm		m/sec	€	KERN	€
SAUTER TU 80-0.01US	0,75-80	0,01	7 MHz ø 6 mm	1000-9999	1310,-	961-113	150,-
TU 230-0.01US	1,2-230	0,01	5 MHz ø 10 mm	1000-9999	1310,-	961-113	150,-
TU 300-0.01US	3-300	0,01	2,5 MHz ø 14 mm	1000-9999	1410,-	961-113	150,-



05 Material thickness gauge for ultrasonic material thickness testing in Echo-Echo principle

Features

- Premium thickness gauge device using ultrasonic technology: New NT measuring technology generation with automatic sensor adjustment (V-path correction for improved accuracy and more rapid display speed)
- Dual measuring modes to determine material thickness:
 - Pulse-Echo mode (up to 600 mm)
 - Echo-Echo mode (up to 100 mm)
- Echo-Echo measurement: Determining the actual thickness of materials regardless of any existing coating, such as, for example, paint or an anti-corrosion coating on the base metal. In this way, the wall thickness, for example of pipes, can be determined in a non-destructive manner, without having to remove the coating and the measurement can be shown on the display, with the adjustment for the coating thickness taken into account
- Can be used on these materials, as well as others: Metals, plastics, ceramics, composite materials, epoxy, glass and other materials
- High-precision mode: Readout accuracy can be switched from 0.1 mm to 0.01 mm
- **1** Premium display with colour TFT display (320×240 mm) with adjustable brightness so that it can be read easily in any environmental conditions

- Large internal data memory for up to 100 data sets each with 100 individual values
- Energy-saving operation with 2× AA batteries and an operating time of at least 30 hours, adjustable power-off time (sleep mode) and adjustable display switch-off (standby mode)
- **2** USB data output for easy data download from the device memory to the PC, as standard
- Adjustment options: 0-point adjustment, 1-point adjustment, 2-point adjustment by measuring material of different thicknesses
- 3 different measurement modes with standard measuring (single measurement), scan mode (for continuous measurement and display of the ACTUAL value, the MIN and MAX value of the measuring sequence) and DIFF mode with calculation of the difference between the ACTUAL measured value and a manually defined nominal thickness
- Limit alarm function: Upper and lower limit adjustable. The measurement process is supported by an audible and visual signal
- Menu languages: DE, EN, FR, ES, IT
- Date and time can be adjusted. It is possible to store the measurement values with a time stamp
- Standard measuring probe SAUTER ATU-US12 included with delivery
- **3** Delivered in a robust carrying case

- Interface cable SAUTER FL-A01 (for use of the software) included

Technical data

- Measuring precision: 0,4 % of [Max] ± 0,04 mm
- Overall dimensions W×D×H 31×69×130 mm
- Battery operation, batteries standard (2×1.5 V AA), AUTO-OFF function to preserve the battery
- Net weight approx. 0,25 kg

Accessories

- External sensor, 5 MHz, ø 10 mm, for echo-echo measuring, SAUTER ATU-US12, **€ 345,-**
- Ultrasound contact gel, refill pack, approx. 70 ml, SAUTER ATB-US03, **€ 35,-**
- Software BalanceConnection, for flexible recording or transmission of measured values, in particular also to Microsoft® Excel or Access as well as transfer of this data to other Apps and programs, For more details see the internet, Scope of supplies: 1 CD, 1 license, KERN SCD-4.0, **€ 189,-**
- Other sensors on request
- Further details and plenty of further accessories see internet www.kern-sohn.com

STANDARD

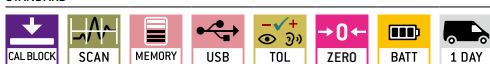

OPTION



Model	Measuring range Echo-Echo	Measuring range Pulse-Echo	Readout [d] mm	Sensor	Sound velocity m/sec	Price	Option
						excl. of VAT ex works €	Factory calibration certificate KERN €
SAUTER TO 100-0.01EE	mm 3-100	mm 0,75-600	0,01	5 MHz ø 10 mm	200-19999	1490,-	KERN 961-113 150,-



06 HARDNESS TESTING OF PLASTICS (SHORE)

To determine the hardness of plastics, in 1915 Albert Shore developed an extremely simple process: A pin made of hardened metal and of a defined shape is held by a spring and is then pushed into the test item. Depending on the depth of the penetration, the material tested is either harder or softer. This procedure is described in DIN ISO 48-4.

Currently, there are two types of devices used for this test: Mechanical measuring devices with drag indicator and electronic measuring devices.

Both types of measuring devices can be operated with test stands (such as the SAUTER TI series). With a test stand, measurements can be carried out more consistently and accurately.

At this time, KERN does not calibrate Shore hardness testing instruments. As an alternative, we recommend that the measuring device is operated with a calibrated kit of hardness comparison plates (such as SAUTER AHBA 01).



Andreas Vossler
Product specialist
Hardness testing of plastics

Tel. +49 7433 9933-243
info@sauter.eu

Quick-Finder

Readout	Measuring range	Hardness scales	Model	Price excl. VAT, ex works €	Page
[d] HS	[Max] HS		SAUTER		
0,1	100 HA	Shore A	HDA 100-1	420,-	67
0,1	100 HA0	Shore C	HDO 100-1	420,-	67
0,1	100 HD	Shore D	HDD 100-1	420,-	67
1	100 HA	Shore A	HBA 100-0	121,-	66
1	100 HO	Shore A0	HBO 100-0	146,-	66
1	100 HD	Shore D	HBD 100-0	167,-	66
-	-	A/A0	TI-AC	270,-	68
-	-	D	TI-ACL	365,-	68
-	-	A/O	TI-D	355,-	68
-	-	D	TI-DL	445,-	68



Compact handheld durometer with drag indicator

Features

- Typical application: measurement of penetration (Shore)
- Particularly recommended for internal comparison measurement. Standard calibrations e.g. to DIN 48-4 are not possible because of very narrow standard tolerances
- Shore A: Rubber, elastomers, neoprene, silicone, vinyl, so plastics, felt, leather and similar material
- Shore D: Plastics, formica, epoxides, plexiglass etc.
- Shore 0: Foam, sponge etc.
- Max mode: Records the peak value indication by drag pointer
- Can be attached to the test stands SAUTER TI-AC (for Shore A and 0), SAUTER TI-D (for Shore D)
- Delivery in a plastic box
- The measuring tips are not interchangeable

Technical data

- Measuring precision: 3 % of [Max]
- Overall dimensions W×D×H 115×60×25 mm
- Net weight approx. 0,15 kg
- Screws to screw on to the TI: M7 fine thread
- Material thickness of the sample, min. 4 mm

Accessories

- Shore comparison plates for testing and calibration of Shore hardness testing devices. By regular comparisons the measuring accuracy increases significantly:
 - 7 hardness comparison plates for Shore A, tolerance up to ± 2 HA, SAUTER AHBA-01, **€ 105,-**
 - 3 hardness comparison plates for Shore D, tolerance up to ± 2 HD, SAUTER AHBD-01, **€ 86,-**
- Factory calibration of the comparison plates, SAUTER 961-170, **€ 119,-**
- Test stand for HBA and HBO, SAUTER TI-AC, **€ 270,-**
- Test stand for HBD, SAUTER TI-D, **€ 355,-**

STANDARD



Model	Hardness scales	Measuring range	Readout	Price excl. of VAT ex works €
SAUTER		[Max]	[d]	
HBA 100-0	Shore A	100 HA	1 HA	121,-
HBO 100-0	Shore 0	100 H0	1 H0	146,-
HBD 100-0	Shore D	100 HD	1 HD	167,-

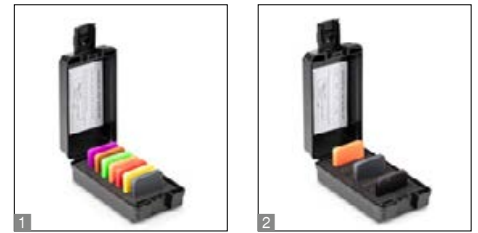

Professional Shore hardness tester

Features

- To measure the hardness of plastics through penetration measurement
- Shore A: Rubber, elastomers, neoprene, silicone, vinyl, so plastics, felt, leather and similar material
- Shore 0: foam, sponge
- Shore D: Plastics, formica, epoxides, plexiglass etc.
- Delivered in a robust carrying case
- Particularly recommended for internal comparison measurement. Standard calibrations e.g. to DIN 48-4 are not possible because of very narrow standard tolerances
- Can be attached to the test stands TI-ACL (for Shore A and 0), TI-DL (for Shore D) to improve measuring uncertainty
- Large display with backlight
- Selectable: AUTO-OFF function or continuous operation, battery level indicator

Technical data

- Tolerance: 1 % of [Max]
- Overall dimensions W×D×H 162×65×38 mm
- Net weight approx. 0,20 kg
- Transfer via RS-232 to the PC, e.g. to Microsoft Excel®
- Battery operation, batteries standard (2×1.5 V AAA)
- Material thickness of the sample, min. 4 mm

Accessories

- Shore comparison plates for testing and calibration of Shore hardness testing devices. By regular comparisons the measuring accuracy increases significantly
 - 1 7 hardness comparison plates for Shore A, tolerance up to ± 2 HA, SAUTER AHBA-01, € 105,-
 - 2 3 hardness comparison plates for Shore D, tolerance up to ± 2 HD, SAUTER AHBD-01, € 86,-
- Factory calibration of the comparison plates, SAUTER 961-170, € 119,-
- Test stand for HDA and HD0, SAUTER TI-ACL, € 365,-
- Test stand for HDD, SAUTER TI-DL, € 445,-
- Data transfer software, interface cable included, SAUTER ATC-01, € 100,-



Model	Hardness scales	Measuring range	Readout	Price excl. of VAT ex works €
SAUTER		[Max]	[d]	
HDA 100-1	Shore A	100 HA	0,1 HA	420,-
HD0 100-1	Shore HA0	100 HA0	0,1 HA0	420,-
HDD 100-1	Shore D	100 HD	0,1 HD	420,-



Lever operated test stand for hardness testing with base plate made of glass

Features

- For Shore hardness testing of plastics, leather etc.
- **1** Glass plate: high measurement accuracy by means of superior hardness of the glass plate
- **2** Mechanical construction: Robust design enables accurate measuring movements
- **3** Level adjustment: For the precise levelling of the base plate, e.g. for the correction of inhomogeneous test objects
- **4** TI-DL: with exchangeable longer column for use with digital hardness tester HD
- Hardness measuring device is not included in delivery

Operation:

1. The SAUTER hardness testing device HB/HD is fitted in a suspended position
 2. The test object is placed on the round testing table right under the durometer measuring tip
 3. By pressing the lever down, the test weight will be released, and this then presses the measuring tip into the test object with its own weight (see table)
- The accuracy of the displayed result is about 25 % higher than in a manual operated test

Technical data

- Stroke length: 15 mm
- Maximum test object height: 63 mm
- Base plate \varnothing 75 mm
- Overall dimensions WxDxH
 TI-AC: 150x110x330 mm
 TI-D: 150x110x400 mm
 TI-ACL: 150x110x380 mm
 TI-DL: 150x110x380 mm

STANDARD

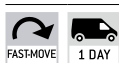

Model	Suitable for	Length of column	Poids de contrôle	Net weight approx.	Price excl. of VAT ex works €
SAUTER		mm	kg	kg	
TI-AC	HBA, HBO	250	1	4,6	270,-
TI-D	HBD	250	5	9	355,-
TI-ACL	HDA, HDO	300	1	4,6	365,-
TI-DL	HDD	300	5	4,6	445,-



07 HARDNESS TESTING OF METALS (LEEB)

Determining the hardness of metals is of particular significance during the preparation and use of metallic materials. Usually, hardness is determined using test machines in accordance with Vickers, Rockwell or Brinell.

For mobile measurements, the rebound method according to Dietmar Leeb, which was first used in 1978, has prevailed. To do this, a standardised impact body (such as SAUTER AHMO D01) is shot against the item to be tested. The rebound of the impact body leads to a deformation of the upper surface, which results in a loss of kinetic energy. This loss of energy is determined by measuring the speed and herefrom the Leeb hardness value (HL) is calculated.

These measuring devices can be used in any location. Usually they are equipped with a large internal data memory, which allows to record the measurements at goods receipt or in production.

Our range is equipped with compact measuring devices of the so-called "Pen Type" shape (HN-D) or measuring devices with external sensors connected by cables.



Andreas Vossler
Product specialist
Hardness testing of metal

Tel. +49 7433 9933-243
info@sauter.eu

Quick-Finder

Readout	Measuring range	Sensor	Model	Price excl. VAT, ex works	Page
[d] HL	[Max] HL		SAUTER	€	
1	960	D	HN-D	930,-	72
1	960	D	HMM-NP	1060,-	71
1	960	D	HMM	1180,-	71
1	960	D	HK-D	1420,-	70
1	960	D	HK-DB	1520,-	70
1	960	D	HMO	2020,-	73



Premium Leeb hardness tester – now also with hardness comparison block included

Features

- External impact sensor standard (Type D)
- Mobility: In comparison with stationary table-top devices and testing devices with an internal sensor, using the SAUTER HK-D offers the highest level of mobility and flexibility
- All measurement directions possible (360°) thanks to an automatic compensation function
- **1** SAUTER HK-DB: Hardness comparison block, hardness approx. 800 HLD, included in delivery
- Measurement value display: Rockwell (Type A, B, C), Vickers (HV), Shore (HS), Leeb (HL), Brinell (HB)
- Internal memory for up to 600 data groups, with up to 32 values per group forming the average value of the group
- Mini statistics function: displays the measured result, the average value, the impact direction, date and time
- Automatic unit conversion: The measuring result is automatically converted into all specified hardness units
- Measuring with tolerance range (limit-setting function): Upper and lower limiting can be programmed individually. The process is supported by an audible and visual signal

- Matrix display: Backlit multi-function display for all relevant functions at a glance
- Robust metal housing
- **2** Delivered in a robust carrying case

Technical data

- Precision: ± 1 % at 800 HLD
- Minimum sample radius (concave/convex): 50 mm (with support ring: 10 mm)
- Thinnest measurable material thickness: 3 mm, with coupling on fixed base
- The lowest weight of the test item on solid support unit: 2 kg with fixed coupling
- Overall dimensions W×D×H 132×82×31 mm
- Permissible ambient temperature -10 °C/40 °C
- Optional battery operation, 2×1.5 V AA not included in scope of delivery, operating time up to 200 h
- Net weight approx. 0,45 kg

Accessories

- Plug-In for data transfer of measuring data from the measuring instrument and transfer to a PC, e.g. in Microsoft Excel®, SAUTER AFI-2.0, € 95,-

- Software BalanceConnection, for flexible recording or transmission of measured values, in particular also to Microsoft® Excel or Access as well as transfer of this data to other Apps and programs, For more details see the internet, Scope of supplies: 1 CD, 1 license, KERN SCD-4.0, € 189,-
- Support rings for bended test objects, SAUTER AHMR 01, € 370,-
- Impact body Type D, net weight approx. 0,05 kg, hardness ≥ 1600 HV, tungsten carbide, Impact ball Ø 3 mm, in accordance with the standard ASTM A956-02, SAUTER AHMO D01, € 115,-
- External impact sensor Type C. Low energy sensor: requires only 25 % impact energy compared to type D, for testing tiny or light objects or the surface of hardened layer, SAUTER AHMR C, € 590,-
- External impact sensor Type D, SAUTER AHMR D, € 590,-
- External impact sensor Type D+15. Slim front section for holes, grooves or re-entrant surfaces, SAUTER AHMR D+15, € 590,-
- External impact sensor Type DL, for very narrow surfaces (Ø 4,5 mm), SAUTER AHMR DL, € 1480,-
- External impact sensor Type G. High energy sensor: 900 % impact energy compared to type D, SAUTER AHMR G, € 1480,-
- Connection cable impact sensor, SAUTER HMO-A04, € 115,-
- **3** Test block Type D/DC, Ø 90 mm (± 1 mm), net weight < 3 kg, hardness range 790 ± 40 HL, SAUTER AHMO D02, € 205,- 630 ± 40 HL, SAUTER AHMO D03, € 205,- 530 ± 40 HL, SAUTER AHMO D04, € 205,-
- Factory calibration certificates for SAUTER AHMO D02, AHMO D03, AHMO D04, SAUTER 961-132, € 150,-

STANDARD



OPTION



Model	Sensor	Measuring range	Readout	Test block	Price excl. of VAT ex works €	Option Factory calibration certificate	
						KERN	€
SAUTER		[Max] HL	[d] HL	Typ D/DC approx. 800 HL			
HK-D	D	170-960	1	not standard	1420,-	961-131	150,-
HK-DB	D	170-960	1	standard	1520,-	961-131	150,-



Advanced features for demanding applications

Features

- **1** Impact (rebound) sensor: The bounce module is accelerated by a spring against the item being tested. Depending on how hard the object is, the kinetic energy of the module will be absorbed. The speed reduction will be measured and converted to Leeb hardness values
- External impact sensor (Type D) included
- Mobility: In comparison with stationary table-top devices and testing devices with an internal sensor, using the SAUTER HMM offers the highest level of mobility and flexibility
- All measurement directions possible (360°) thanks to an automatic compensation function
- **2** Hardness test block for calibration included (790 ± 40 HL)
- Internal memory for up to 9 measurement values
- Mini statistics function: displays the measured result, the average value, the impact direction, date and time
- SAUTER HMM-NP: identical product features as the SAUTER HMM model, but comes without the printer

- Measurement value display: (B & C), Vickers (HV), Brinell (HB), Shore (HSD), Leeb (HL), tensile strength (MPa)
- Automatic unit conversion: The measuring result is automatically converted into all specified hardness units
- **3** Delivered in a robust carrying case

Technical data

- Precision: ± 1 % at 800 HLD (± 6 HLD)
- Measuring range tensile strength: 375–2639 MPa (steel)
- Minimum sample weight on a solid and stable support: 2 kg with fixed coupling
- Minimum sample material thickness: 3 mm with coupling on fixed base
- Minimum sample radius (concave/convex): 50 mm (with support ring: 10 mm)
- Overall dimensions W×D×H 150×80×30 mm
- SAUTER HMM: External mains adapter for printer, as standard
- Batteries included, 3×1.5 V AAA, operating time up to 30 h, AUTO-OFF function to preserve the battery
- Net weight approx. 0,25 kg

Accessories

- External impact sensor Type D, as standard, can be reordered, SAUTER AHMO D, **€ 315,-**
- Connection cable, without impact sensor, SAUTER HMM-A02, **€ 45,-**
- **3** Support rings for bended test objects, SAUTER AHMR 01, **€ 370,-**
- **4** Impact body Type D, net weight approx. 0,05 kg, hardness ≥ 1600 HV, tungsten carbide, Impact ball Ø 3 mm, in accordance with the standard ASTM A956-02, SAUTER AHMO D01, **€ 115,-**
- Test block Type D/DC, Ø 90 mm (± 1 mm), net weight < 3 kg, hardness range 790 ± 40 HL, SAUTER AHMO D02, **€ 205,-** 630 ± 40 HL, SAUTER AHMO D03, **€ 205,-** 530 ± 40 HL, SAUTER AHMO D04, **€ 205,-**
- Paper roll, 1 piece, SAUTER ATU-US11, **€ 17,-**
- Factory calibration certificates for SAUTER AHMO D02, AHMO D03, AHMO D04, SAUTER 961-132, **€ 150,-**



Model	Sensor	Measuring range	Readout	Price	
				excl. of VAT ex works €	Option Factory calibration certificate €
SAUTER HMM	D	[Max] HL 170-960	[d] HL 1	1180,-	KERN 961-131 150,-
HMM-NP	D	170-960	1	1060,-	961-131 150,-



“Pen type“ Leeb hardness tester for mobile hardness testing of metals

Features

- User-friendly operation: The compact version enables the product to be used in a significantly wider range of applications compared with traditional devices
- The measuring device has been designed for one-hand operation and this allows the user to work more quickly and flexibly
- Modern LCD display: Optimised for industrial applications: increased luminosity and backlight can be switched on, that way the display can be read from any angle
- All measurement directions possible (360°) thanks to an automatic compensation function
- Internal impact sensor included (Type D)
- Measurement value display: (B & C), Vickers (HV), Brinell (HB), Leeb (HL)
- Standard block for calibration not included in scope of delivery
- Internal data memory for up to 500 measurements with date and time
- Data interface USB, including USB interface cable
- **1** Delivered in a robust carrying case

Technical data

- Measurement uncertainty ± 4 HLD
- Minimum sample weight on a solid and stable support: 2 kg with fixed coupling
- Thinnest measurable material thickness: 3 mm, with coupling on fixed base
- Overall dimensions WxDxH 22x35x147 mm
- Rechargeable battery pack integrated, as standard, operating time up to 16 h without backlight, charging time approx. 3 h
- Mains adapter external, standard
- Net weight approx. 0,20 kg

Accessories

- Plug-In for data transfer of measuring data from the measuring instrument and transfer to a PC, e.g. in Microsoft Excel®, SAUTER AFI-2.0, **€ 95,-**
- Impact body Type D, net weight approx. 0,05 kg, hardness ≥ 1600 HV, tungsten carbide, Impact ball $\varnothing 3$ mm, in accordance with the standard ASTM A956-02, SAUTER AHMO D01, **€ 115,-**
- **2** Test block Type D/DC, $\varnothing 90$ mm (± 1 mm), net weight < 3 kg, hardness range 790 ± 40 HL, SAUTER AHMO D02, **€ 205,-** 630 ± 40 HL, SAUTER AHMO D03, **€ 205,-** 530 ± 40 HL, SAUTER AHMO D04, **€ 205,-**
- Factory calibration certificates for SAUTER AHMO D02, AHMO D03, AHMO D04, SAUTER 961-132, **€ 150,-**

STANDARD



OPTION



Model	Sensor	Measuring range	Readout	Price		Option	
				excl. of VAT ex works €	€	Factory calibration certificate	€
SAUTER		[Max] HL	[d] HL			KERN	
HN-D	D	170-960	1	930,-		961-131	150,-



Advanced features for professional applications

Features

- Innovative touchscreen
- Automatic recognition of the impact (rebound) sensor connected to the HMO
- Mobility: In comparison with stationary table-top devices and testing devices with an internal sensor, using the SAUTER HMO offers the highest level of mobility and flexibility
- All measurement directions possible (360°) by defining the direction of impact on the device
- USB bearing for connection to the printer and charging the batteries
- **1** Standard block for calibration included
- Internal data memory for up to 500 values
- Mini statistics function: Displays the measure value, the average value, the difference between the maximum and minimum values, date and time
- Measurement value display: (B & C), Vickers (HV), Brinell (HB), Leeb (HL), tensile strength (MPa)
- Automatic unit conversion: The measuring result is automatically converted into all specified hardness units
- **2** Delivered in a robust carrying case

Technical data

- Precision: $\pm 1\%$ at 800 HLD (± 6 HLD)
- Measuring range tensile strength: 375–2639 MPa (steel)
- Minimum sample weight on a solid and stable support: Sensor D + DC: 2 kg with fixed coupling
- Minimum sample material thickness: Sensor D + DC: 3 mm with coupling on fixed base
- Minimum sample radius (concave/convex): 50 mm (with support ring: 10 mm)
- Overall dimensions WxDxH 24x83x135 mm
- Internal rechargeable battery pack, operating time up to 50 h without backlight, charging time approx. 8 h, standard
- Mains adapter included
- Net weight approx. 0,25 kg

Accessories

- External impact sensor Type D, as standard, can be reordered, SAUTER AHMO D, **€ 315,-**
- **3** External impact sensor Type DC. Short impact sensor for tests in holes or hollowed objects, SAUTER AHMO DC, **€ 455,-**
- **4** External impact sensor Type G. High energy sensor: 9-fold impact energy compared to type D, SAUTER AHMO G, **€ 1595,-**
- On request: Support rings for bended test objects, SAUTER AHMR 01, **€ 370,-**
- **5** Impact body Type D, net weight approx. 0,05 kg, hardness ≥ 1600 HV, tungsten carbide, Impact ball $\varnothing 3$ mm, in accordance with the standard ASTM A956-02, SAUTER AHMO D01, **€ 115,-**
- Connection cable impact sensor, SAUTER HMO-A04, **€ 115,-**
- Test block Type D/DC, $\varnothing 90$ mm (± 1 mm), net weight < 3 kg, hardness range 790 ± 40 HL, SAUTER AHMO D02, **€ 205,-** 630 ± 40 HL, SAUTER AHMO D03, **€ 205,-** 530 ± 40 HL, SAUTER AHMO D04, **€ 205,-**
- Paper roll, 1 piece, SAUTER ATU-US11, **€ 17,-**

07

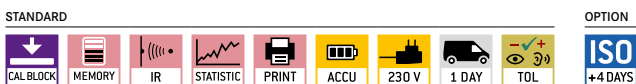

Model	Sensor	Measuring range	Readout	Price		Option	
				excl. of VAT ex works €	Factory calibration certificate	KERN	€
SAUTER HMO	D	[Max] HL 170-960	[d] HL 1	2020,-	961-131	150,-	

ASSORTMENT RANGE LEADER AND HIDDEN CHAMPION IN THE REGION: KERN WEIGHING & MEASURING TECHNOLOGY

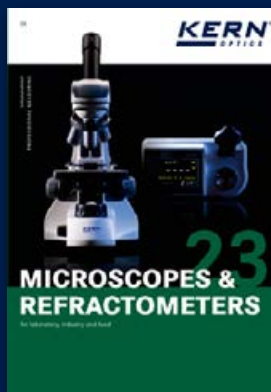

KERN – the king of broad product ranges

Reliable, easy, durable products from the world of weighing and measuring technology, innovative software and the competent test service from KERN and SAUTER will win you over.

The best thing to do is to request our special catalogues straightaway – free of charge, of course!

There is also plenty for you to discover online: latest offers, new models, sale items and interesting news ...

You can also place orders by going online unter: www.kern-sohn.com



PROFESSIONAL MEASURING

08 HARDNESS TESTING OF METALS (UCI)



Ultrasonic contact impedance (UCI) hardness testing devices are filling wisely a void in the area of hardness testing.

This area of testing is, on one hand, dominated by mobile hardness testing devices which are using the Leeb procedure and, on the other hand, by stationary hardness testing devices which are predominantly carrying out destructive tests.

Because of the high demands required by this system on the minimum weight and thickness of the test object, the Leeb procedure is not suitable for the majority of tests for small test objects. A good example of this is hardness testing of the flanks of gear wheels. Often in this test, the question is whether the flanks have been hardened or whether the hardened layer has already been removed.

UCI hardness testing devices therefore are offering significantly better measurement performance at small test objects in comparison with Leeb hardness testing devices.

One advantage of the UCI hardness testing devices compared with stationary hardness testing machines is, that the test object does not have to be cut out of the whole object.

By using the optional support rings, the minimum weight of the test object can even be reduced from 300 g to 100 g.

By means of optional ISO calibration, SAUTER UCI hardness testing devices can be used not only for internal testing purposes but also for measurements where the results have to be changed externally.



Andreas Vossler
Product specialist

Hardness testing of metals (UCI)

Tel. +49 7433 9933-243
info@sauter.eu

Quick-Finder

Hardness scale	Model	Price excl. VAT, ex works €	Page
	SAUTER		
HV 1	HO 1K	5820,-	76
HV 2	HO 2K	5820,-	76
HV 5	HO 5K	5820,-	76
HV10	HO 10K	5820,-	76

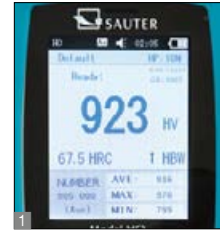

Premium UCI hardness testing device for Rockwell, Brinell and Vickers

Features

- Application: This ultrasound hardness testing device is ideally suited for mobile hardness testing, where the main emphasis is on obtaining rapid and precise results
- Principle: The SAUTER HO measures by using a vibrating rod which vibrates at ultrasonic frequency and is pressed onto the sample at a defined test force. At the lower end there is a Vickers indenter. Its resonant frequency increases as soon as an indentation is created when it comes into contact with the sample. Through appropriate adjustment of the device, the resulting change in resonant frequency is matched with the corresponding Vickers hardness
- Examples: The SAUTER HO ultrasound hardness testing system is primarily used for measuring small forgings, castings, welding points, punched parts, casting tools, ball bearings and the flanks of gear wheels as well as for measuring the influence of warmth or heat
- Advantages compared with Rockwell and Brinell: Means that the testing is almost nondestructive, small penetrations means that the testing is less destructive

- Advantages compared with Vickers: Demanding optical measuring is not required. You can therefore carry out measurements directly on-site, for example, on a permanently installed workpiece
- Advantages compared with Leeb: The high requirements concerning the proper weight of the test object can be widely omitted
- Standards: The device meets following technical standards: DIN 50159-1; ASTM-A1038-2005; JB/T9377-2013
- Measurement data memory saves up to 1000 measurement groups each with 20 individual values
- **1** Mini statistics function: Display of the measuring result, the number of measurements, the maximum and minimum value as well as the average value and the standard deviation
- Calibration: The device can be set to both standard hardness test blocks as well as to up to 20 reference calibration values. When doing this it is possible to measure different materials quickly, without having to re-adjust the device to the individual materials
- **2** Scope of delivery: Standard block for calibration (approx. 61 HRC), USB cable, Display unit, UCI sensor unit, transport case, software to transfer the saved data to the PC, accessories

Technical Data

- Measuring ranges: HRC: 20,3–68; HRB: 41–100; HRA: 61–85,6; HV: 80–1599; HB: 76–618; Tensile strength: 255–2180 N/mm²
- Measurement precision: ± 3 % HV; ± 1,5 HR; ± 3 % HB
- Display units: HRC, HV, HBS, HBW, HK, HRA, HRD, HR15N, HR30N, HR45N, HS, HRF, HR15T, HR30T, HR45T, HRB.
- Rechargeable battery pack integrated, as standard, operating time up to 12 h without backlight, charging time approx. 8 h
- Minimum weight of the test object: 300 g for direct measurement with the sensor (included); 100 g with supporting ring (optional)
- Minimum thickness of the test object: 2 mm
- Minimum dimensions the test surface size around: approx. 5×5 mm (recommended)
- Overall dimensions W×D×H 28×83×160 mm
- Net weight approx. 0,50 kg

08

Mobile ultrasound hardness testing device SAUTER HO



Accessories

- External impact sensor Type D, as standard, can be reordered, SAUTER AHMO D, € 315,-
- 7 Calibration and adjustment plate (hardness test blocks) with defined and tested steel hardness for regular testing and adjustment of hardness testing devices. The hardness values are indicated. A key feature of the plates is the low-granular, homogenous finish of the steel, \varnothing 90 mm, including calibration certificate
28 to 35 HRC, SAUTER HHO-A09, € 440,-
38 to 43 HRC, SAUTER HO-A10, € 440,-
48 to 53 HRC, SAUTER HO-A11, € 440,-
58 to 63 HRC, SAUTER HO-A12, € 440,-

- 8 Test stand for repeatable movements during testing. In this way you can avoid errors which could occur in manual handling of the sensor. This ensures even more stable measurements and more precise measuring results. Smooth-running mechanical system, stroke length 34 mm, maximum height of the test object within the test stand 240 mm, swivel probe device for measurements outside the base plate, very robust construction, net weight approx. 9 kg, SAUTER HO-A08, € 1610,-
- Motorised probe. Enables testing at the touch of a button while maintaining the same procedure (while stocks last)
HV 0,3, SAUTER HO-A15, € 3900,-
HV 0,5, SAUTER HO-A16, € 3900,-
HV 0,8, SAUTER HO-A17, € 3900,-
HV 1, SAUTER HO-A18, € 3900,-

SAUTER HO 1K, HO 2K

- 3 Support ring, flat, SAUTER HO-A04N, € 510,-
- 4 Support ring, small cylinder, \varnothing 8-20 mm, SAUTER HO-A05N, € 510,-
- 5 Support ring, large cylinder, \varnothing 20-80 mm, SAUTER HO-A06N, € 510,-

SAUTER HO 5K, HO 10K

- 3 Support ring, flat, SAUTER HO-A04, € 510,-
- 4 Support ring, small cylinder, \varnothing 8-20 mm, SAUTER HO-A05, € 510,-
- 5 Support ring, large cylinder, \varnothing 20-80 mm, SAUTER HO-A06, € 510,-
- 6 Deep-hole protective cover, SAUTER HO-A07, € 280,-

STANDARD



OPTION



Model	Hardness scale	Min. weight of test item	Min. thickness of test item	Price excl. of VAT ex works €	Option	
					Factory calibration certificate	
		g	mm		KERN	€
SAUTER HO 1K	HV 1	300	2	5820,-	961-270	325,-
SAUTER HO 2K	HV 2	300	2	5820,-	961-270	325,-
SAUTER HO 5K	HV 5	300	2	5820,-	961-270	325,-
SAUTER HO 10K	HV 10	300	2	5820,-	961-270	325,-



OCCUPATIONAL SAFETY/ ENVIRONMENT

Prevention of accidents as well as modern health care have got the same operational starting point in many countries. With industrialisation and the formation of conurbations, transport infrastructures and large companies, regular preventive medical examinations were introduced for wide sections of the population.

In addition to preventive medical examinations, monitoring of working conditions with defined limits was also introduced. To date, the regular checking of these limits as part of safety and accident prevention measures is domiciled as a business responsibility up till now.

For this purpose, SAUTER provides a targeted selection of the most commonly-used instruments in general measuring technology. They can be used to measure environmental influences such as noise (acoustic pressure) or light.

For regular calibration, our pick-up and return service can be used, which will save you a lot of efforts and expenses.



Irmgard Russo
Product specialist
Occupational safety/Environment

Tel. +49 7433 9933-208
info@sauter.eu

Quick-Finder

Readout	Measuring range	Model	Price excl. VAT, ex works €	P.
[d] lx/dB	[Max] lx/dB	SAUTER		
0,1	130	SU 130	128,-	81
0,1	134	SW 1000	2 150,-	82
0,1	136	SW 2000	1 320,-	82
0,1 1 10 100	200 2000 20000 200000	SO 200K	92,-	79
0,1 1 10 100	200 2000 20000 200000	SP 200K	105,-	80



Photometer for precise light measurement up to 200,000 Lux

Features

- Helps to determine if workplace lighting meets standard requirements, e.g. DIN EN 12464-1 "Lighting of workplaces indoors"
- Photo sensor: silicon diode
- Cosine correction for angular incident light
- Track function for continuous recording of changing environmental conditions
- Peak Hold function to capture peak value
- Selectable measuring units: fc (foot-candle), lux
- Sturdy protective cover for the photo sensor
- Increased service life: Impact protection by means of a protective casing
- **1** Delivery in a robust box

Technical data

- Measuring frequency: 2 Hz
- Cable length (Photo sensor) approx. 1 m
- Overall dimensions W×D×H 160×72×40 mm
- Battery operation, battery not standard (9V Block), AUTO-OFF function for battery conservation
- Net weight approx. 0,25 kg



Model	Measuring range	Readout	Price excl. of VAT ex works €	Option	
				Factory calibration certificate	
	[Max] lx	[d] lx		KERN	€
SAUTER	200	0,1	92,-	961-190	205,-
SO 200K	2000	1			
	20000	10			
	200000	100			



Compact photometer, optimised for accurate light measurement, including LED light measurement

Features

- For measuring illumination of office workstations, production workstations, etc.
- Photo sensor: silicon diode, filtered
- Cosine correction for angular incident light
- Data-hold function, to freeze the current measurement
- 1 Rotatable sensor unit (+90 and -180°) for optimum alignment to the light source
- Track function for continuous recording of changing environmental conditions
- By pressing the key, the current measured value can be frozen until the key is pressed again
- Selectable measuring units: fc (foot-candle), lux
- Easy to toggle between units at the press of a button
- Option of fitting a stand on the rear of the housing, 1/4" thread
- Sturdy protective cover for the photo sensor
- 2 Increased service life: Impact protection through delivery in a soft box with light protection

Technical data

- Measurement precision up to 20.000 Lux: ± 4 % of the result + 10 scale intervals
- Measurement precision from 20.000 Lux: ± 5 % of the result + 10 scale intervals
- Repeatability: ± 2 % of [Max]
- Temperature error: ± 0,1 % von [Max]/°C
- Measuring frequency: 2 Hz
- Overall dimensions W×D×H 185×68×38 mm
- Ready for use: Battery included, 9 V block, operating time up to 200 h
- Net weight approx. 0,15 kg

09

STANDARD OPTION

BATT 1 DAY +10 DAYS

Model	Measuring range	Readout	Price excl. of VAT ex works €	Option	
				Factory calibration certificate	
	[Max] lx	[d] lx		KERN	€
SAUTER	0-200	0,1			
SP 200K	200-2000	1	105,-	961-190	205,-
	2000-20000	10			
	20000-200000	100			



Professional sound level meter

Features

- Professional sound level meter for measuring noise in areas such as, environment, mechanical applications, car industry and much more
- Measures the sound intensity in the workplace
- Helps in differentiating between normal noise influences, and excessive noise, nuisances e.g. in a production hall
- **1** Data interface RS-232, included
- Multi measuring functions:
 - Lp: Standard sound level measuring function
 - Leq: Energy equivalent sound level measuring mode (type A)
 - Ln: Shows the deviation from a pre-defined limit in %
- Selectable methods of evaluation:
 - A: As sensitive as the human ear
 - C: Sensitive for noisier environmental conditions, where there are machines, plant, motors etc.
 - F: For areas with constant sound intensity
- Limit value function: programmable value for the maximum level value
- Track function for continuous recording of changing environmental conditions

- Peak Hold function to capture peak value
- Internal memory for 30 measured values, transferable to PC with SAUTER ATC-01
- **2** Delivered in a robust carrying case

Technical data

- Measuring precision: 3 % of [Max]
- Dimensions W×D×H 236×63×26 mm
- Battery operation, batteries standard (4×1.5 V AAA)
- Net weight approx. 0,20 kg

Accessories

- Data transfer software, interface cable included, SAUTER ATC-01, **€ 100,-**
- Adjustment device for regular adjustment of the sound level meter, SAUTER ASU-01, **€ 290,-**
- Foam protective cover, SAUTER ASU-02, **€ 8,-**



Model	Type	Measuring range [Min]-[Max] dB	Readout [d] dB	Price excl. of VAT ex works €	Option Factory calibration certificate	
					KERN	€
SAUTER SU 130	Lp A	30-130	0,1	128,-	961-281	235,-
	Lp C	30-130				
	Lp F	30-130				



First-class professional Class I, Class II sound level meter

09

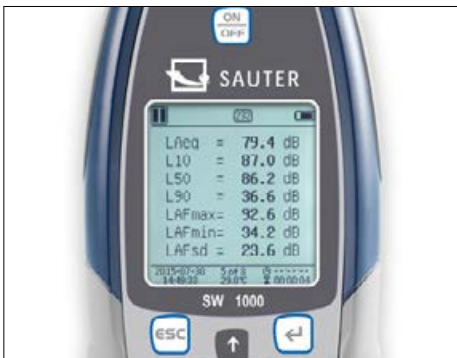

Data logging function with date and time in the device...



... and data transfer using MicroSD (4G) memory card (included in delivery), RS-232 or USB

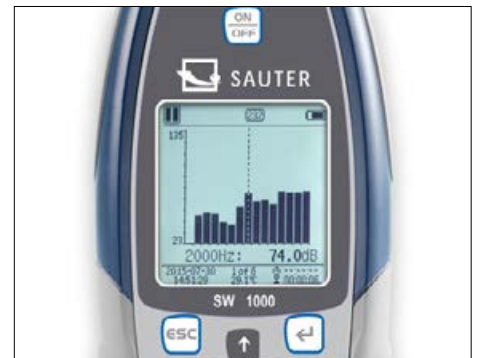



Different sound pressure levels can be selected, such as, Laeq, LcPeak, LaF, LaFMax, LaFMin, SD, SEL, E

Sound level meter SAUTER SW





Features

- Ideal for measurements for workplaces outdoor, e.g. at airports, on building sites, in road traffic etc. with wide frequency access
- Modern microcontroller architecture for increased stability and accuracy
- A specially-developed algorithm permits a compliant dynamic range of more than 120 dB! (SW 1000: > 123 dB; SW 2000: > 122 dB)
- Three profiles and 14 user-defined measurements can be calculated in parallel with different frequency and time weighting
- LN statistics and display of the graph showing the progression of time
- User-defined integral interval measurement up to a maximum of 24 hours is possible
- Frequency weighting (filter) A, B, C, Z
- Time interval during measurement: F (fast), S (slow), I (pulse)
- Freely-definable limits for the output of an optical alarm signal
- Peak Hold function to capture peak value
- Octave function for targeted sound analysis, can be expanded to 1/3 octave through the purchase of a licence
- TRACK function with graphic display of a measurement
- Calibration mode (with optional calibrator)
- Trigger mode: external start/stop of measurement via 3.5 mm connector
- Automatic measurement for timer function is possible
- Operating languages: EN, DE, FR, ES, PT
-  Option of fitting a stand on the rear of the housing, 1/4" thread
-  Delivery in robust transport case

Technical data

- Applicable standards:
 - IEC61672-1:2014-07
 - GB/T3785.1-2010
 - 1/1 Octave in accordance with IEC 61260:2014
- 1/2" microphone
- Output (direct or alternating current) AC (max 5 VRMS), DC (10 mV/DB)
- Mains operation as standard
- Battery operation possible, 4x1.5 V AA not included, operating time up to 10 h
- Overall dimensions WxDxH 300x80x36 mm
- Permissible ambient temperature -10 °C/50 °C
- Net weight approx. 0,40 kg

Accessories

- Plug-In for data transfer of measuring data from the measuring instrument and transfer to a PC, e.g. in Microsoft Excel®, SAUTER AFI-2.0, **€ 95,-**
-  Stand, WxDxH 430x90x90 mm, 1250x750x750 mm (moved out), SAUTER SW-A05, **€ 70,-**
- SD-memory card, storage capacity 4 GB, SAUTER SW-A04, **€ 54,-**
- Foam protective cover, SAUTER SW-A03, **€ 45,-**
-  Calibrator for regular adjustment of the sound level meter, class 1, as well as testing the linearity of sound level meters
 - Applicable standards: IEC60942:2003 Class 1, ANSI S1.40-1984, GB/T 15173-1994.
 - Output frequency 1 kHz (+/- 0,5 %)
 - Output of acoustic pressure, can be selected at 94 dB or 114 dB (± 0.3 dB)
 - Distortion factor < 2 %
 - Stabilisation time < 10 s
 - Permissible ambient temperature range -10 °C/50 °C
 - The calibrator is designed for 1/2" as well as 1/4" microphones (adapter included in the delivery) in accordance with the IEC 61094-4 standard
 - Battery operation, 2x 1.5 V AA, not standard, operating time up to 40 hours
 - Dimensions WxDxH 70x70x48 mm
 - Net weight approx. 137 g, SAUTER BSWA-01, **€ 770,-**
 - Factory calibration certificate, for calibrator, SAUTER 961-291, **€ 182,-**
 - DAKkS calibration certificate, for calibrator, SAUTER 963-291, **€ 255,-**
- Expansion of the octave band to 1/3 octave, SAUTER SW-A10, **€ 440,-**

STANDARD



OPTION



Model	Accuracy class	Measuring range Linear range [Min]-[Max] dB	Readout [d] dB	Frequency range [Min]-[Max] kHz	Sensitivity mV/Pa	Price excl. of VAT ex works €	Option DAKkS calibration certificate		Option Factory calibration certificate	
							DAKkS KERN	€	KERN	€
SAUTER SW 1000	1	20-134	0,1	0,01-20	50	2150,-	963-281	335,-	961-281	235,-
SAUTER SW 2000	2	25-136	0,1	0,02-12,5	40	1320,-	963-281	335,-	961-281	235,-

10



SYSTEM SOLUTIONS INDUSTRY 4.0 /DISPLAY DEVICES

BALANCE MANUFACTURE

Load cell + Junction Box + KERN YKV

FORCE MEASUREMENT

Load cell + SAUTER FL + Software

BALANCE CONSTRUCTION

Load cell + evaluation device

BALANCE MANUFACTURE

Load cell + KERN YKV + KERN Software BalanceConnection

BALANCE MANUFACTURE

Load cell + Junction Box + evaluation device



We help to interlink industrial production with state-of-the-art information and communication technology with the aim of increasing quality, using costs, time and resources more efficiently and being able to react more flexibly to the demands of the future. You can benefit from our standardized data protocols in conjunction with our BalanceConnection 4.0 data software, for details see Internet.

The SAUTER team of our competence center – Industry 4.0 (IoT)



Daniel Egeler



Ralf Schmiegl



Maximilian Pfister

▷ We are glad to inform and advise you
Tel. +49 7433 9933-200
ITsupport@kern-sohn.com

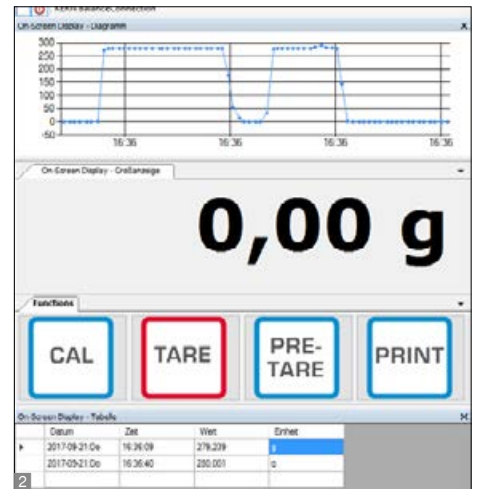

Modern digital weighing transmitter for the rapid recording of weighing data and forwarding it to the most varied output channels such as tablets, networks, SPS controllers, etc.
 – ideal for operating balances in systems or conveyors

Features

- With this digital weighing transmitter your weighing processes are ready for the requirements of Industry 4.0. Simply connect a weighing platform or load cell, integrate the digital weighing transmitter into the network and start weighing
- For rapid transfer of weighing data to connected networks, computers, etc.
- USB and RS-232 data interface standard, Power supply via USB interface
- Transfer formats are freely configurable
- Functions: Weighing, taring
- Measuring frequency 10 Hz
- Easy configuration using the software supplied
- Robust plastic die-cast housing

- **1** Suitable for wall mounting and DIN track mount
- Compatible with all KERN weighing platforms
- Included with the delivery:
 - Digital weighing transmitter KERN YKV-01
 - USB cable incl. mains plug
 - DIN rail mounting bracket
 - Configuration software for adjusting and managing, for large-format display of the values collected on the PC as well as transfer of this data to other Apps and programs. The displayed result can therefore be converted to any format for communication with the different user programs, such as, e.g. SAP, Oracle etc.

Technical data

- Overall dimensions W×D×H 100×140×36 mm
- Net weight approx. 0,35 kg
- Permissible ambient temperature -10 °C/40 °C

Accessories

- Bluetooth data interface, KERN YKV-A02, **€ 98,-**
- WiFi interface, KERN YKV-A01, **€ 98,-**
- **2** Software BalanceConnection, for flexible recording or transmission of measured values, in particular also to Microsoft® Excel or Access as well as transfer of this data to other Apps and programs, For more details see the internet, Scope of supplies: 1 CD, 1 license, KERN SCD-4.0, **€ 189,-**

STANDARD											FACTORY	
CAL EXT	RS 232	USB	LAN	KCP PROTOCOL	GLP PRINTER	UNIT	B MULTI	1 DAY	BT 4.0	WLAN		

Model	Standard interfaces	Price excl. of VAT ex works €
KERN YKV-01	RS-232, USB	265,-
KERN YKV-02	RS-232, USB, Ethernet	320,-

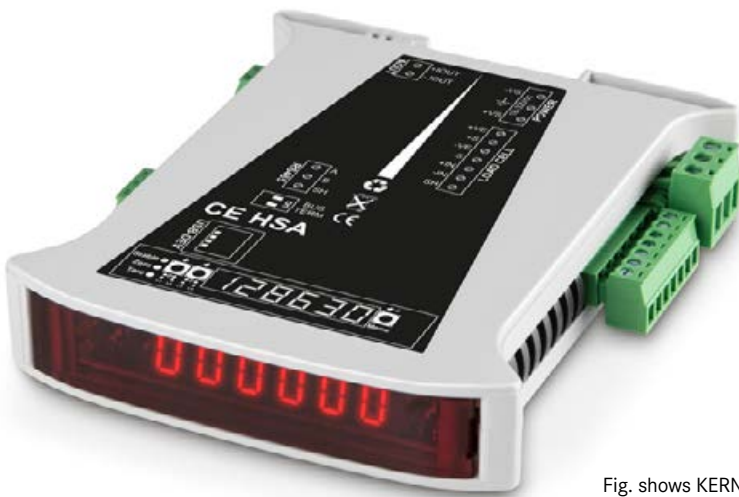

Fig. shows KERN CE HSA



Super compact display device (rail-mounted module) for installation in switch cabinets

Features

- Compact display unit for recording weighing data using strain gauge load cells, e.g. in industrial applications
- Due to its small size, it is particularly space-saving to install in switch cabinets
- Thanks to the many interface variants, the modules can be ideally integrated into existing infrastructures and systems
- The modules can be used either individually or as a Buslink system with a total of up to 332 DIN rail modules
- The configuration of the module can be carried out conveniently via a connected PC with the suitable software (Download see web)
- Bright LED display for optical control and settings
- Time-saving G-Cal™ (Geographic Calibration) technology for fast and accurate calibration without weights conveniently over a network or the Internet worldwide
- Convenient communication via remote devices
- Backup and restore function via USB port

- Can handle various industrial protocols such as Ethernet IP, Modbus TCP, Modbus RTU, FINS, PROFIBUS DP and PROFINET (according to model)
- Extremely high measurement frequency possible, up to 1600 data records/s
- Internal resolution 24 Bit

Technical data

- 7 segment LED display, digit height 7,62 mm
- Dimensions W×D×H 120×101×23 mm
- Power supply 18-32 Vdc; 4 W max.
- Load cell power supply 5 Vdc
- Sensitivity 0,1 µV/d
- Adjustable nominal sensitivity: 1; 1.5; 2; 2.5; 3 mV/V
- Input voltage Unipolar @3mV/V: -1 mV to +16 mV
- Input voltage Bipolar @3mV/V: -16 mV to +16 mV
- Max. load cell impedance: 1200Ω
- Min. load cell impedance: 43,75 Ω
- Max. no. of load cells 350 Ω: 8

- Max. no. of load cells 1000 Ω: 22
- Max. number of d: 10.000
- Display steps: 1, 2, 5, 10, 20, 50, 100, 200
- Permissible ambient temperature -10 °C/40°C

Accessories

- Mains adapter for voltage supply to the KERN CE, can be fitted on the DIN rail, KERN CE HSS, € 90,-
- Large display with superior display size, KERN YKD-A02, € 310,-
- For further accessories, such as load and load cells, torque sensors and weighing platforms (strain gauge based only) from the SAUTER and KERN range, see www.sauter.eu
- Further accessories such as DIN rail, housing as well as individual assembly, configuration, adjustment, etc. on request

Note: Models also available with verification approval, please enquire

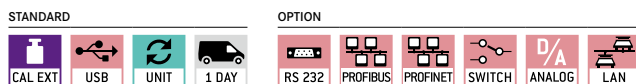

Model	Communication/Interfaces	Digital I/O	Analog output	Price excl. of VAT ex works €
KERN				
CE HSA*	USB	-	0/4-20/24mA	495,-
CE HSAIO ^{NEW}	USB	3 input/4 output	0/4-20/24mA	640,-
CE HSE*	USB, Ethernet	3 input/4 output	-	560,-
CE HSP*	USB, PROFIBUS	3 input/4 output	-	560,-
CE HSR*	USB, RS232/422	3 input/4 output	-	530,-
CE HSN	USB, PROFINET	3 input/4 output	-	560,-

^{NEW} New model

[!] * ONLY WHILE STOCKS LAST



Analogue weighing transmitter to amplify the DMS signal with current or voltage output (depending on model)

Features

- Voltage supply 12V or 24V
- Output signal voltage or current
- Suitable for transfer to SPS, analogue measuring card etc.
- Integrated overvoltage protection
- Polarity reversal protection at the input and protection of the output
- CE WT1-Y4 and CE WT2-Y4: up to 4 sensors connectable without junction box
- Scope of delivery: weighing transmitter, connection plug for sensor, cable incl. plug for output signal and power supply
- 12V DC or 24V DC voltage source (depending on model) required (e.g. for 24V voltage source CE is HSS compatible)
- Compatible with all analogue SAUTER load cells and analogue KERN weighing platforms

Technical data

- Measuring range 0 - 20 mV
- Accuracy: $\leq \pm 0.1\%$ F.S.
- Ambient temperature: -20 to +85°C
- Overall dimensions WxDxH
 CE WT1: 110x45x32 mm, see larger picture
 1 CE WT2: 110x45x32 mm
 2 CE WT4: 110x45x32 mm
- Net weight
 CE WT1: approx. 0,25 kg
 CE WT2: approx. 0,50 kg
 CE WT4: approx. 0,85 kg

Accessories

- Mains adapter for power supply of the KERN CE (only for models with 24 V), KERN CE HSS, € 90,-

STANDARD

CAL EXT	D/A	IP 54	IP 65	1 DAY
---------	-----	-------	-------	-------

Model	Sensor connections	Supply voltage	Output signal	Housing	Class of protection	Price excl. of VAT ex works €
SAUTER						
CE WT1-Y1	1	12V	Analog (4 - 20 mA)	Steel plate	IP54	175,-
CE WT2-Y1	1	24V	Analog (4 - 20 mA)	Steel plate	IP54	175,-
CE WT3-Y1	1	12V	Analog 0 +/-5V	Steel plate	IP54	175,-
CE WT4-Y1	1	24V	Analog 0 +/-5V	Steel plate	IP54	175,-
CE WT1-Y2	1	12V	Analog (4 - 20 mA)	Aluminium	IP65	270,-
CE WT2-Y2	1	24V	Analog (4 - 20 mA)	Aluminium	IP65	270,-
CE WT2-Y4	4	24V	Analog (4 - 20 mA)	Aluminium	IP65	350,-
CE WT1-Y4	4	12V	Analog (4 - 20 mA)	Aluminium	IP65	350,-



LOAD CELLS

Various accuracy classes with nominal loads from 300 g to 100 t and protection classes up to IP69K are available to you in the SAUTER product range. Whatever the project – whether it’s the development of customised weighing systems, installation in silos and storage tanks or in shelving for continuous inventory, for special application in mechanical engineering or in any type of test stand – SAUTER can offer you just the right load cell.

Of course, we can also supply you with the appropriate accessories such as load corners, pivot heads, display devices, junction boxes or the relevant calibration certificate at the same time.

Any special requests? Do you need special load cells, other capacities or cable lengths, individual force test stands or a special mount for your test item? No problem, our product specialist for load cells Mr Stefan Herrmann is available at any time to help you and will work with you to develop a customised concept for your application.

Accuracy class	Combined error
C5	≤ 0,01 %
C4	≤ 0,015 %
C3	≤ 0,02 %
C2	≤ 0,03 %
C1	≤ 0,05 %
G1	≤ 0,1 %
G2	≤ 0,2 %
G3	≤ 0,3 %
G5	≤ 0,5 %
G10	≤ 1,0 %

Note

Individual scale construction according to your individual requirements, also possible with third-party components see page 99



Stefan Herrmann

Product specialist Load cells

Tel. +49 7433 9933-214
 stefan.herrmann@kern-sohn.com



Tip

Analogue torque sensors are compatible with the SAUTER CE HSx display device (rail-mounted module) (see page 86)

DC Y1

Alloy steel static torque sensor

STANDARD



- High precision (comprehensive Error 0,5 % F.S.)
- RoHS compliant
- For monitoring or measurement of static torques, tests of manual torque wrenches or transfer of static load torques
- Nominal sensitivity 1.0~1.5 mV/V, depending on nominal load
- Supply voltage max. 10 V DC
- 4-wire connection
- Simple and quick installation
- High torsional stiffness
- Other designs and nominal loads on request

DC Y2

Alloy steel static torque sensor

STANDARD



OPTION



- High precision (comprehensive Error 0,3 % F.S.)
- RoHS compliant
- Dust and spray protection to IP65 (in accordance with EN 60529)
- For monitoring or measurement of static torques, tests of manual torque wrenches or transfer of static load torques
- Nominal sensitivity 1,5 mV/V
- Supply voltage max. 15 V DC
- 4-wire connection
- High torsional stiffness
- Other designs and nominal loads on request

Model	Nominal load Nm	Price excl. of VAT ex works €
SAUTER		
DC 5-Y1	5	290,-
DC 10-Y1	10	285,-
DC 20-Y1	20	285,-
DC 50-Y1	50	285,-
DC 100-Y1	100	285,-
DC 200-Y1	200	285,-
DC 500-Y1	500	360,-

Model	Nominal load Nm	Price excl. of VAT ex works €
SAUTER		
DC 200M-Y2	0,2	490,-
DC 1-Y2	1	490,-
DC 10-Y2	10	490,-
DC 20-Y2	20	490,-
DC 50-Y2	50	490,-

Tip

- Further details and technical data sheet as well as an extensive range of accessories can be found at www.sauter.eu



CP P4 · CP Y4

Single-point load cells made of anodised aluminium

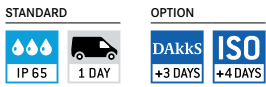

- CP P4: Accuracy in accordance with OIML R60 C3
- CP Y4: Accuracy in accordance with OIML R60 C2
- CE and RoHS compliant
- Dust and spray protection to IP65 (in accordance with EN 60529)
- Aluminium, anodised
- Suitable for price-computing scales, bench scales, platform scales, etc.
- Maximum platform size 200×200 mm
- 4-wire connection
- Nominal sensitivity: 0,9 mV/V

Model	Nominal load	Price excl. of VAT ex works
SAUTER	kg	€
CP 300-0P4	0,3	65,-
CP 600-0P4	0,6	65,-

Model	Nominal load	Price excl. of VAT ex works
SAUTER	kg	€
ECO design		
CP 300-0Y4	0,3	55,-
CP 1500-0Y4	1,5	55,-
CP 3000-0Y4	3	55,-

CP P1 · CP Y1

Single-point load cells made of anodised aluminium

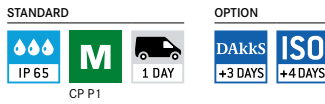

- CP P1: Accuracy in accordance with OIML R60 C3
- CP Y1: Accuracy in accordance with OIML R60 C2
- CE and RoHS compliant
- Dust and spray protection to IP65 (in accordance with EN 60529)
- Aluminium, anodised
- Suitable for price-computing scales, bench scales, platform scales, etc.
- Maximum platform size 250×350 mm
- 4-wire connection
- Nominal sensitivity: 2 mV/V
- Note: Version in accordance with OIML R60 C4 or C5 on request

Model	Nominal load	Price excl. of VAT ex works
SAUTER	kg	€
CP 3-3P1	3	60,-
CP 5-3P1	5	60,-
CP 6-3P1	6	60,-
CP 8-3P1	8	60,-
CP 10-3P1	10	60,-
CP 15-3P1	15	60,-
CP 20-3P1	20	60,-
CP 30-3P1	30	60,-
CP 35-3P1	35	60,-
CP 40-3P1	40	60,-
CP 50-3P1	50	60,-

Model	Nominal load	Price excl. of VAT ex works
SAUTER	kg	€
ECO design (without EC type approval)		
CP 3-2Y1	3	33,-
CP 5-2Y1	5	33,-
CP 10-2Y1	10	33,-
CP 15-2Y1	15	33,-
CP 20-2Y1	20	33,-
CP 30-2Y1	30	33,-

CP P3

Single-point load cells made of anodised aluminium

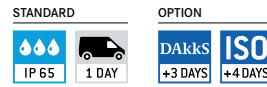

- Accuracy in accordance with OIML R60 C3
- CE and RoHS compliant
- Dust and spray protection to IP65 (in accordance with EN 60529)
- Suitable for price-computing scales, bench scales, platform scales, etc.
- Maximum platform size 350×400 mm
- 4-wire connection
- Nominal sensitivity: 2 mV/V
- Note: Version in accordance with OIML R60 C4 on request

Model	Nominal load	Price excl. of VAT ex works
SAUTER	kg	€
CP 30-3P3	30	76,-
CP 40-3P3	40	76,-
CP 50-3P3	50	76,-
CP 75-3P3	75	76,-
CP 100-3P3	100	77,-

Tip

Further details and technical data sheet as well as an extensive range of accessories can be found at www.sauter.eu



CP P2 · CP P8

Single-point load cell of aluminium

STANDARD
 IP 65
 1 DAY

OPTION
 DAKkS +3 DAYS
 ISO +4 DAYS

- Accuracy in accordance with OIML R60 C3
- RoHS compliant
- Dust and spray protection to IP65 (in accordance with EN 60529)
- Aluminium, anodised
- Suitable for price-computing scales, bench scales, etc.
- Maximum platform size 100–300 kg: 400×400 mm
- Maximum platform size 400–500 kg: 450×450 mm
- Nominal sensitivity: 2 mV/V
- Note: Version in accordance with OIML R60 C4 or C5 on request

CP P7

Single-point load cells of Stainless steel

STANDARD
 IP 67
 1 DAY

OPTION
 DAKkS +3 DAYS
 ISO +4 DAYS

- Accuracy in accordance with OIML R60 C3
- RoHS compliant
- Dust and spray protection to IP67 (in accordance with EN 60529)
- Stainless steel
- Application example: Weight as well as compressive force measurements under harsh environmental conditions
- Suitable for bench scales, price-computing scales
- Maximum platform size 400×400 mm
- 6-wire connection
- Nominal sensitivity: 2 mV/V
- Note: Version in accordance with OIML R60 C4 on request

CP P9

Single-point load cells of stainless steel

STANDARD
 IP 68
 IP 69K
 M
 1 DAY

OPTION
 DAKkS +3 DAYS
 ISO +4 DAYS

- Accuracy in accordance with OIML R60 C3
- RoHS compliant
- Dust and spray protection to IP68/IP69K (in accordance with EN 60529), welded to create a hermetic seal
- Stainless steel
- Area of application: Weight measurement as well as compressive force in harsh environments
- Suitable for platform scales, checkweighers
- Maximum platform size 10–50 kg: 400×400 mm
- Maximum platform size 100–500 kg: 800×800 mm
- 4-wire connection (10–50 kg)
- 6-wire connection (100–500 kg)
- Nominal sensitivity: 2 mV/V
- Note: Version in accordance with OIML R60 C4 or C5 on request

Model	Nominal load	Price
	kg	excl. of VAT ex works €
SAUTER		
CP 100-3P2	100	81,-
CP 150-3P2	150	81,-
CP 200-3P2	200	81,-
CP 300-3P2	300	81,-
CP 400-3P2	400	81,-
CP 500-3P2	500	81,-
CP 50-3P8	50	123,-
CP 100-3P8	100	123,-
CP 150-3P8	150	123,-
CP 200-3P8	200	123,-
CP 250-3P8	250	123,-
CP 300-3P8	300	123,-
CP 500-3P8	500	123,-
CP 600-3P8	600	123,-

Model	Nominal load	Price
	kg	excl. of VAT ex works €
KERN		
CP 30-3P7	30	270,-
CP 50-3P7	50	270,-
CP 75-3P7	75	270,-
CP 100-3P7	100	270,-
CP 150-3P7	150	270,-

Model	Nominal load	Price
	kg	excl. of VAT ex works €
SAUTER		
CP 10-3P9	10	380,-
CP 20-3P9	20	380,-
CP 50-3P9	50	380,-
CP 100-3P9	100	570,-
CP 200-3P9	200	580,-
CP 300-3P9	300	580,-
CP 400-3P9	400	580,-
CP 500-3P9	500	580,-

ONLY WHILE STOCKS LAST!

New model

Tip

Further details and technical data sheet as well as an extensive range of accessories can be found at www.sauter.eu

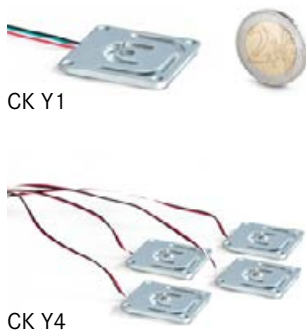
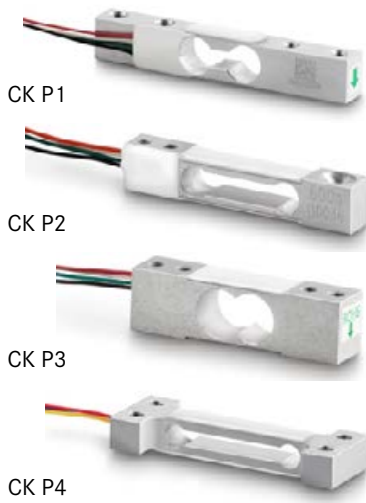
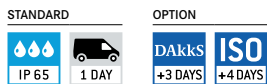

Fig. shows optional accessories, mounting kit SAUTER CE P4136

CK P1-4

Miniature load cells made of aluminium



- Dust and spray protection to IP65 (in accordance with EN 60529)
- Aluminium
- High level of accuracy
- Suitable for small scales and kitchen scales and force-measuring devices
- 4-wire connection

CK Y1 · Y4

Flat miniature alloy steel load cells

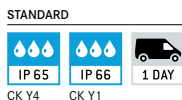

- Accuracy class in accordance with OIML C1
- RoHS compliant
- High precision (comprehensive Error 0,05 % F.S.)
- Very low design
- Suitable for e.g. personal scales, kitchen scales, post scales or other scales with lowest installation height

CK Y1:

- Protection against dust and water splashes IP66
- Scope of delivery: 1 piece
- Full-bridge circuit (Junction box required for connecting several load cells)

CK Y4:

- Protection against dust and water splashes IP65
- Scope of delivery: 1 set (4 pieces)
- Quarter-bridge circuit: 4 load cells are connected to a full-bridge
- No junction box required
- Corner adjustment not possible

CD P1

Load cells made of stainless steel



- Accuracy in accordance with OIML R60 C3
- RoHS compliant
- Dust and spray protection to IP68 (in accordance with EN 60529), hermetically encapsulated
- Stainless steel
- Area of application: Weight measurement as well as compressive force
- Suitable for vehicle scales, funnel scales, vehicle testing equipment, test stands
- Note: EX version or accuracy class C4 on request
- Nominal sensitivity: 2 mV/V

Accessories CD P1:

- Pressure piece, steel, rustproof, suitable for CD 10-3P1, CD 20-3P1, SAUTER CE P10330, € 98,-
- Pressure piece, steel, rustproof, suitable for CD 40-3P1, CD 50-3P1, SAUTER CE P10350, € 92,-
- Mounting kit, steel, rustproof, suitable for CD 10-3P1, CD 20-3P1, SAUTER CE P41430, € 660,-
- Mounting kit, steel, rustproof, suitable for CD 40-3P1, CD 50-3P1, SAUTER CE P14150, € 730,-

Model	Nominal load	Comprehensive Error	Price excl. of VAT ex works
SAUTER			
	kg		€
CK 600-0P1	0,6	0,03 %	33,-
CK 1-0P1	1	0,03 %	33,-
CK 2-0P1	2	0,03 %	33,-
CK 3-0P1	3	0,03 %	33,-
CK 5-0P1	5	0,03 %	33,-
CK 6-0P1	6	0,03 %	33,-
CK 300-0P2	0,3	0,03 %	49,-
CK 600-0P2	0,6	0,03 %	49,-
CK 1000-0P3*	1	0,1 %	27,-
CK 100-0P4	0,1	0,05 %	44,-
CK 120-0P4	0,12	0,05 %	44,-
CK 300-0P4	0,3	0,05 %	44,-
CK 500-0P4	0,5	0,05 %	44,-

* ONLY WHILE STOCKS LAST!

Model	Nominal load	Price excl. of VAT ex works
SAUTER		
	kg	€
CK 10-Y1	10	23,-
CK 30-Y1	30	23,-
CK 10-Y4	10	23,-
CK 30-Y4	30	25,-
CK 50-Y4	50	25,-

Model	Nominal load	Price excl. of VAT ex works
SAUTER		
		€
CD 10-3P1	10 t/100 kN	460,-
CD 20-3P1	20 t/200 kN	460,-
CD 40-3P1	40 t/400 kN	460,-
CD 50-3P1	50 t/500 kN	460,-

* up to max. 25 t/250 kN

! ONLY WHILE STOCKS LAST!

Tip

- Further details and technical data sheet as well as an extensive range of accessories can be found at www.sauter.eu



Fig. shows accessories, load corner SAUTER CE Q42901, for further accessories please visit our online shop

CR Q1

Load cells made of stainless steel

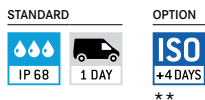

- Accuracy in accordance with OIML R60 C1
- RoHS compliant
- Dust and spray protection to IP68 (in accordance with EN 60529), hermetically encapsulated
- Stainless steel
- Area of application: Weight measurement as well as compressive force
- Suitable for vehicle scales, funnel scales, vehicle testing equipment, test stands
- Nominal sensitivity: 2 mV/V

Accessories CR Q1:

- Load corner, steel, galvanised, suitable for CR Q1 with nominal load ≤ 10 t, SAUTER CE Q42901, € 265,-
- Load corner, steel, galvanised, suitable for CR Q1 with nominal load ≥ 20 t, SAUTER CE Q42902, € 420,-
- Load corner, steel, rustproof, suitable for CR Q1 with nominal load ≤ 10 t, SAUTER CE RQ42901, € 475,-
- Load corner, steel, rustproof, suitable for CR Q1 with nominal load ≥ 20 t, SAUTER CE RQ42902, € 810,-

Model	Nominal load	Price excl. of VAT ex works
SAUTER		
CR 2500-1Q1	2,5 t/25 kN	285,-
CR 5000-1Q1	5 t/50 kN	285,-
CR 10000-1Q1	10 t/100 kN	285,-
CR 20000-1Q1	20 t/200 kN	560,-
CR 30000-1Q1	30 t/300 kN	560,-

** up to max. 25 t/250 kN

CR P1

Load cells made of stainless steel

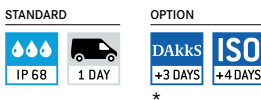

- Accuracy in accordance with OIML R60 C3
- RoHS compliant
- Dust and spray protection to IP68 (in accordance with EN 60529), hermetically encapsulated
- Stainless steel
- Area of application: Weight measurement as well as compressive force
- Suitable for truck scales, suspended scales, silo scales and other diverse scales, test stands, etc.
- Nominal sensitivity: 1-2 mV/V, depending on nominal load

Accessories CR P1:

- Load corner for CR 1000-3P1, CR 250-3P1, CR 500-3P1 Steel, incl. pressure piece, SAUTER CE P244011, € 600,-
- Pressure piece for CR 1000-3P1, CR 250-3P1, CR 500-3P1 steel, SAUTER CE P244012, € 115,-
- Load corner for CR 2000-3P1 steel, rustproof, incl. pressure piece, SAUTER CE P244021, € 720,-
- Pressure piece for CR 2000-3P1 steel, rustproof SAUTER CE P244022, € 125,-

Model	Nominal load	Price excl. of VAT ex works
SAUTER		
CR 60-3P1	60 kg/0,6 kN	930,-
CR 130-3P1	130 kg/1,3 kN	980,-
CR 250-3P1	250 kg/2,5 kN	980,-
CR 500-3P1	500 kg/5 kN	860,-
CR 1000-3P1	1000 kg/10 kN	860,-
CR 2000-3P1	2000 kg/20 kN	860,-

* up to max. 500 kg/5 kN

CR Y1

Load cells made of alloyed steel

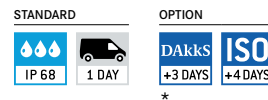

- High precision (comprehensive Error 0,05 % F.S.)
- Accuracy in accordance with OIML R60 C1
- RoHS compliant
- Dust and spray protection to IP68 (in accordance with EN 60529), hermetically encapsulated
- Stainless steel
- Area of application: for weight, tensile and compressive force measurement
- Suitable for weight measurement as well as force and force test stands
- Force transmission via pressure piece or threaded hole
- Nominal sensitivity: 2 mV/V
- Pressure piece included in delivery
- Thread for pressure piece or other force application: up to 5000 kg M16×1,5, from 10000 kg M32×1,5

Model	Nominal load	Price excl. of VAT ex works
SAUTER		
CR 500-1Y1	0,5 t/5 kN	270,-
CR 1000-1Y1	1 t/10 kN	270,-
CR 5000-1Y1	5 t/50 kN	270,-
CR 10000-1Y1	10 t/100 kN	430,-
CR 20000-1Y1	20 t/200 kN	430,-

* up to max. 500 kg/5 kN

Tip

- Further details and technical data sheet as well as an extensive range of accessories can be found at www.sauter.eu



Fig. shows accessories, base plate 1 SAUTER CE Q30903 and bearings 2 SAUTER CE Q30904, for further accessories please visit our online shop



Fig. shows optional accessories load corner 3 SAUTER CE P4022

CB Q1 · CB Q2

Bending beam and shear beam load cells made of stainless steel



- Accuracy in accordance with OIML R60 C3
- CE and RoHS compliant
- Dust and spray protection to IP68/IP69K (in accordance with EN 60529), welded to create a hermetic seal
- Stainless steel
- Area of application: Weight measurement as well as compressive force in harsh environments
- Suitable for platform scales, funnel scales, floor scales and other weighing devices
- 4-wire connection
- Nominal sensitivity: 2 mV/V
- Note: Accuracy class OIML R60 C6 or EX version on request

* up to max. 500 kg

Model	Nominal load kg	Price excl. of VAT ex works €
SAUTER		
CB 5-3Q1	5	230,-
CB 10-3Q1	10	230,-
CB 20-3Q1	20	230,-
CB 30-3Q1	30	230,-
CB 50-3Q1	50	230,-
CB 75-3Q1	75	230,-
CB 100-3Q1	100	230,-
CB 150-3Q1	150	230,-
CB 200-3Q1	200	230,-
CB 250-3Q1	250	230,-
CB 300-3Q1	300	230,-
CB 500-3Q1	500	230,-
CB 750-3Q2**	750	240,-
CB 1000-3Q2**	1000	240,-
CB 1500-3Q2**	1500	240,-

11 ** ONLY WHILE STOCKS LAST!

CB P1

Load cells made of stainless steel



- Accuracy in accordance with OIML R60 C3
- CE and RoHS compliant
- Dust and spray protection to IP67 (in accordance with EN 60529), hermetically encapsulated
- Nickel-plated steel
- Area of application: Weight measurement as well as compressive force in harsh environments
- Suitable for platform scales, silo scales, bed scales and other diverse scales
- 4-wire connection
- Nominal sensitivity: 3 mV/V

Model	Nominal load kg	Price excl. of VAT ex works €
SAUTER		
CB 100-3P1	100	114,-
CB 250-3P1	250	114,-

Accessories CB Q1 · CB Q2:

- Traction device, steel, galvanised, suitable for CB Q1, SAUTER CE Q30901, € 85,-
- Traction device, steel, rustproof, suitable for CB Q2, SAUTER CE Q34905, € 90,-
- 1 Base plate, steel, galvanised, suitable for CB Q1, SAUTER CE Q30903, € 100,-
- Base plate, steel, rustproof, suitable for CB Q1, SAUTER CE RQ30903, € 190,-
- Base plate, steel, rustproof, suitable for CB Q2, SAUTER CE Q34903, € 95,-
- 2 Bearing, steel, rustproof, suitable for CB Q1 (nominal load 5 kg-50 kg), SAUTER CE Q30904, € 120,-
- Bearing, steel, rustproof, suitable for CB Q1 (nominal load 75 kg-300 kg), SAUTER CE Q30905, € 120,-
- Bearing, steel, rustproof, suitable for CB 500-3Q1, SAUTER CE Q30906, € 205,-
- Bearing, steel, rustproof, suitable for CB 750-3Q2, CB 1000-3Q2, CB 1500-3Q2, SAUTER CE Q34906, € 190,-
- Load corner, steel, galvanised, suitable for CB Q1, SAUTER CE Q30907, € 220,-
- Load corner, steel, rustproof, suitable for CB Q1, SAUTER CE RQ30907, € 315,-
- Adjustable foot, steel, rustproof, suitable for SAUTER CE Q34901, € 70,-

Accessories CB P1:

- Adjustable foot, steel, nickel-plated, load base M12 for CT 500-3P1, CT 1000-3P1 and CT 1500-3P1, SAUTER CE P2012, € 27,-
- 3 Load corner, steel, nickel-plated for CT 500-3P1, CT 1000-3P1 and CT 1500-3P1, SAUTER CE P4022, € 195,-
- Spacer plates for bending beam CB P1 made of steel, SAUTER CE P3012, € 9,-

Tip

- Further details and technical data sheet as well as an extensive range of accessories can be found at www.sauter.eu



Fig. shows optional accessories load corner 1 SAUTER CE RQ35903



Fig. shows optional accessories load corner 2 SAUTER CE P4022

CT Q1

Shear beam made of stainless steel

STANDARD

- IP 68
- IP 69K
- 1 DAY

OPTION

- DAkkS
- ISO
- +3 DAYS
- +4 DAYS

- Accuracy in accordance with OIML R60 C3
- CE and RoHS compliant
- Dust and spray protection to IP68/IP69K (in accordance with EN 60529), welded to create a hermetic seal
- Stainless steel
- Area of application: Weight measurement as well as compressive force in harsh environments
- Suitable for platform scales, funnel scales, flush-mounted floor scales and other weighing devices
- 6-wire connection
- Nominal sensitivity: 2 mV/V
- Note: EX version on request

Model	Nominal load	Price
SAUTER	kg	excl. of VAT ex works €
CT 300-3Q1	300	220,-
CT 500-3Q1	500	220,-
CT 750-3Q1	750	220,-
CT 1000-3Q1	1000	220,-
CT 1500-3Q1	1500	220,-
CT 2000-3Q1	2000	220,-
CT 3000-3Q1	3000	435,-
CT 5000-3Q1	5000	435,-
CT 7500-3Q1	7500	570,-
CT 10000-3Q1	10000	570,-

* up to max. 500 kg

CT P1 · CT P2

Load cells made of stainless steel

STANDARD

- IP 67
- M
- 1 DAY

OPTION

- DAkkS
- ISO
- +3 DAYS
- +4 DAYS

- Accuracy in accordance with OIML R60 C3
- CE and RoHS compliant
- Dust and spray protection to IP67 (in accordance with EN 60529), welded to create a hermetic seal
- Nickel-plated steel
- Area of application: Weight measurement as well as compressive force in harsh environments
- Suitable for platform scales, funnel scales, flush-mounted floor scales and other weighing devices
- 4-wire connection
- Nominal sensitivity: 3 mV/V
- Note: EX version, 6-wire connection and accuracy class C4 or C5 on request
- **CT P2:** Delivery with calibrated characteristic value, if several cells are ordered, this means significantly less effort when aligning the corners of a platform

Model	Nominal load	Price
SAUTER	kg	excl. of VAT ex works €
CT 500-3P1	500	98,-
CT 1000-3P1	1000	98,-
CT 1500-3P1	1500	98,-
CT 2500-3P1	2500	119,-
CT 3000-3P1	3000	119,-
CT 5000-3P1	5000	119,-
CT 10000-3P1	10000	173,-
CT 500-3P2	500	103,-
CT 1000-3P2	1000	103,-
CT 3000-3P2	3000	125,-
CT 5000-3P2	5000	124,-
CT 10000-3P2	10000	178,-

* up to max. 500 kg

Accessories CT Q1:

- Base plate, steel, rustproof, suitable for CT Q1, SAUTER CE RQ35911, € 200,-
- Base plate, steel, rustproof, suitable for CT 3000-3Q1, CT 5000-3Q1, SAUTER CE RQ35912, € 200,-
- Base plate, steel, rustproof, suitable for CT 7500-3Q1, CT 10000-3Q1, SAUTER CE RQ35919, € 860,-
- Bearing, steel, rustproof, suitable for CT Q1, SAUTER CE RQ35909, € 165,-
- Bearing, steel, rustproof, suitable for CT 3000-3Q1, CT 5000-3Q1, SAUTER CE RQ35910, € 320,-
- Bearing, steel, rustproof, suitable for CT 7500-3Q1, CT 10000-3Q1, SAUTER CE RQ35918, € 390,-
- Load corner, steel, rustproof, suitable for CT Q1, SAUTER CE RQ35902, € 420,-
- Load corner, steel, rustproof, suitable for CT 3000-3Q1, CT 5000-3Q1, SAUTER CE RQ35903, € 620,-

Accessories CT P1 · CT P2:

- Load corner, steel, rustproof, suitable for CT 10000-3P1, CT 10000-3P2, SAUTER CE P40210, € 510,-
- Load corner, steel, nickel-plated, suitable for CT 500-3P1, CT 1000-3P1, CT 1500-3P1, SAUTER CE P4022, € 195,-
- Load corner, steel, nickel-plated, suitable for CT 2500-3P1, CT 3000-3P1, CT 5000-3P1, SAUTER CE P4025, € 260,-
- Adjustable foot, steel, rustproof, suitable for CT 500-3P1, CT 1000-3P1, CT 1500-3P1, SAUTER CE P2012, € 27,-
- Adjustable foot, steel, rustproof, suitable for CT 2500-3P1, CT 3000-3P1, CT 5000-3P1, SAUTER CE P2018, € 38,-
- Adjustable foot, steel, rustproof, suitable for CT 10000-3P1, SAUTER CE P2024, € 113,-
- Spacer plate for CT 500-3P1, CT 500-3P2, CT 1000-3P1, CT 1000-3P2 and CT 1500-3P1, SAUTER CE P3012, € 9,-
- Spacer plate for CT 2500-3P1, CT 3000-3P1, CT 3000-3P2, CT 5000-3P1 and CT 5000-3P2 SAUTER CE P3015, € 8,-
- Spacer plate for CT 10000-3P1 and CT 10000-3P2 SAUTER CE P30110, € 27,-

Tip

Further details and technical data sheet as well as an extensive range of accessories can be found at www.sauter.eu



Fig. shows optional accessories SAUTER CE R20, for further accessories please visit our online shop



Fig. shows optional accessories traction device SAUTER CE Q12, for further accessories please visit our online shop



CS P2 0,5-7,5 t

CS P2 50-250 kg

CS P1

4-wire “S” load cells made of nickel-plated steel for force and mass measurement

STANDARD: IP 67, 1 DAY
 OPTION: DAKkS +3 DAYS, ISO +4 DAYS

- Accuracy in accordance with OIML R60 C3
- RoHS compliant
- Dust and spray protection to IP67 (in accordance with EN 60529), welded to create a hermetic seal
- Nickel-plated steel
- Scope of application: for tensile and compressive force measurement
- Suitable for handling scales, funnel scales and other weighing devices as well as force measurement devices and test stands
- 4-wire connection***
- Note: EX version and accuracy class C4 on request
- Nominal sensitivity: 2 mV/V

CS Q1

6-wire “S” load cells made of nickel-plated steel for force and mass measurement

STANDARD: IP 67, 1 DAY
 OPTION: DAKkS +3 DAYS, ISO +4 DAYS

- Accuracy in accordance with OIML R60 C3
- RoHS compliant
- Dust and spray protection to IP67 (in accordance with EN 60529), hermetically encapsulated
- Nickel-plated steel
- Scope of application: for tensile and compressive force measurement
- Suitable for handling scales, funnel scales and other weighing devices as well as force measurement devices and test stands
- 6-wire connection***
- Nominal sensitivity: 2 mV/V

CS P2

“S” load cells/load cells made of stainless steel

STANDARD: IP 68, 1 DAY
 OPTION: DAKkS +3 DAYS, ISO +4 DAYS

- Accuracy in accordance with OIML C3
- RoHS compliant
- Dust and spray protection to IP68
- Stainless steel
- Scope of application: Weight measurement as well as force
- Suitable for handling scales, silo scales, force test stands and other diverse scales
- 4-wire connection***
- Nominal sensitivity: 2 mV/V

Model	Nominal load	Price excl. of VAT ex works €
SAUTER		
CS 25-3P1	25 kg/250 N	200,-
CS 50-3P1	50 kg/500 N	200,-
CS 100-3P1	100 kg/1 kN	200,-
CS 150-3P1	150 kg/1,5 kN	200,-
CS 250-3P1	250 kg/2,5 kN	200,-
CS 500-3P1	500 kg/5 kN	200,-
CS 600-3P1	600 kg/6 kN	200,-
CS 750-3P1	750 kg/7,5 kN	200,-
CS 1000-3P1	1 t/10 kN	230,-
CS 1500-3P1	1.5 t/15 kN	230,-
CS 2000-3P1	2 t/20 kN	260,-
CS 2500-3P1	2.5 t/25 kN	260,-
CS 5000-3P1	5 t/50 kN	260,-
CS 7500-3P1	7.5 t/75 kN	530,-
CS 10000-3P1	10 t/100 kN	530,-
CS 15000-3P1	15 t/150 kN	690,-
CS 20000-3P1	20 t/200 kN	760,-
CS 30000-3P1	30 t/300 kN	1950,-

* up to max. 500 kg/5 kN,
 ** up to max. 25 t/250 kN

Model	Nominal load	Price excl. of VAT ex works €
SAUTER		
CS 50-3Q1	50 kg/500 N	215,-
CS 100-3Q1	100 kg/1 kN	215,-
CS 150-3Q1	150 kg/1,5 kN	215,-
CS 200-3Q1	200 kg/2 kN	215,-
CS 300-3Q1	300 kg/3 kN	215,-
CS 500-3Q1	500 kg/5 kN	215,-
CS 750-3Q1	750 kg/7,5 kN	215,-
CS 1000-3Q1	1 t/10 kN	215,-
CS 1500-3Q1	1.5 t/15 kN	250,-
CS 2000-3Q1	2 t/20 kN	250,-
CS 3000-3Q1	3 t/30 kN	370,-
CS 5000-3Q1	5 t/50 kN	370,-
CS 6000-3Q1	6 t/60 kN	370,-

* up to max. 500 kg/5 kN,
 ** up to max. 12 t/120 kN

Model	Nominal load	Price excl. of VAT ex works €
SAUTER		
CS 50-3P2	50 kg/500 N	430,-
CS 100-3P2	100 kg/1 kN	460,-
CS 250-3P2	250 kg/2,5 kN	430,-
CS 500-3P2	500 kg/5 kN	335,-
CS 1000-3P2	1 t /10 kN	340,-
CS 2000-3P2	2 t/20 kN	340,-
CS 5000-3P2	5 t/50 kN	405,-
CS 7500-3P2	7.5 t/75 kN	405,-

* up to max. 500 kg/5 kN

*** With 6-wire measuring circuits, the cable can be shortened without affecting the temperature compensation and the actual characteristic value. For 4-wire measuring circuits the cable length should not be changed

Tip

Further details and technical data sheet as well as an extensive range of accessories can be found at www.sauter.eu



CS Y1



CO Y1



CO Y2/CO Y3



CO Y4



CS Y1

Miniature “S” load cells/load cells made of stainless steel



- High precision (comprehensive Error 0,05 % F.S.)
- RoHS compliant
- Dust and spray protection to IP65
- Stainless steel
- Scope of application: for tensile and compressive force measurement, Weight measurement as well as force
- Suitable for force test stands, handing scales, silo scales and other diverse scales
- Nominal sensitivity: 1,3 – 2 mV/V, depending on nominal load

CO Y1 – Y4

Miniature button-type load cells made of stainless steel

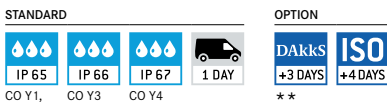

- RoHS compliant
- Dust and spray protection to IP65/IP67
- Scope of application: compressive force applications
- Suitable for Weight measurement as well as force and force test stands
- Nominal sensitivity: 1.0 – 1.5 mV/V, depending on nominal load

CO Y2/Y3:

- RoHS compliant
- Dust and spray protection to IP65/IP66
- Scope of application: for tensile and compressive force measurement
- Suitable for Weight measurement as well as force and force test stands
- Nominal sensitivity: 1,5 – 2 mV/V, depending on nominal load

CO Y5

Tension and compression load cells made of stainless steel

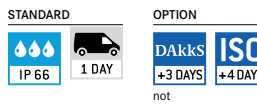

- Accuracy in accordance with OIML R60 G1
- CE and RoHS compliant
- Dust and spray protection to IP66 (in accordance with EN60529)
- Stainless steel
- Very low design
- Suitable for test stands, force gauges, automation systems, etc.
- 4-wire connection
- Nominal sensitivity: CO 0.5-Y5, CO 1-Y5: 1 mV/V
CO 5-Y5, CO 10-Y5: 2 mV/V

Model	Nominal load	Price excl. of VAT ex works €
SAUTER		
CS 1-Y1	1 kg/ 10 N	345,-
CS 2-Y1	2 kg/20 N	345,-
CS 5-Y1	5 kg/50 N	345,-
CS 10-Y1	10 kg/100 N	345,-
CS 20-Y1	20 kg/200 N	345,-

Model	Nominal load	Price excl. of VAT ex works €
SAUTER		
CO 10-Y1	10 kg/100 N	170,-
CO 20-Y1	20 kg/200 N	170,-
CO 50-Y1	50 kg/500 N	170,-
CO 100-Y1	100 kg/1 kN	170,-
CO 200-Y1	200 kg/2 kN	170,-
CO 500-Y1	500 kg/5 kN	200,-
CO 1000-Y1	1000 kg/10 kN	200,-
CO 2000-Y1	2000 kg/20 kN	235,-
CO 10-Y2	10 kg/100 N	250,-
CO 20-Y2	20 kg/200 N	250,-
CO 50-Y2	50 kg/500 N	250,-
CO 100-Y2	100 kg/1 kN	310,-
CO 200-Y2	200 kg/2 kN	310,-
CO 500-Y2	500 kg/5 kN	310,-
CO 1000-Y2	1000 kg/10 kN	310,-
CO 2000-Y2	2000 kg/20 kN	345,-
CO 5-Y3	5 kg/50 N	380,-
CO 10-Y3	10 kg/100 N	380,-
CO 5-Y4	5 kg/50 N	235,-
CO 10-Y4	10 kg/100 N	230,-

Model	Nominal load	Price excl. of VAT ex works €
SAUTER		
CO 0.5-Y5	0,5 kg/5 N	365,-
CO 1-Y5	1 kg/10 N	365,-
CO 5-Y5	5 kg/50 N	365,-
CO 10-Y5	10 kg/100 N	365,-

** up to 500 kg/5 kN



CJ P4



CJ P6



CJ P4PG



CJ X467



CJ X468

CJ P

Junctionbox for connecting several measuring cells to one evaluation unit

STANDARD

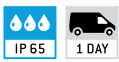

- Prepared for 4-wire and 6-wire load cells
- Models available for 2, 4, 6 or 8 load cells
- Robust aluminium die-cast housing
- Protection against dust and spray IP65

CJ X

Junctionbox for connecting several measuring cells to one evaluation unit

STANDARD

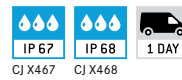

- Prepared for 4-wire and 6-wire load cells
- Models available for 4 load cells

CJ X467:

- Robust stainless steel housing with protection against dust and water splashes IP67

CJ X468:

- Robust aluminium die-cast housing with protection against dust and water splashes IP68

Model	Number of connection options	Price excl. of VAT ex works €
SAUTER		
CJ P2	2	87,-
CJ P4	4	87,-
CJ P4PG	4	98,-
CJ P6 *	6	108,-
CJ P8 *	8	108,-

* ONLY WHILE STOCKS LAST!

Model	Number of connection options	Price excl. of VAT ex works €
SAUTER		
CJ X467	4	220,-
CJ X468	4	130,-

Tip

- Further details and technical data sheet as well as an extensive range of accessories can be found at www.sauter.eu

12 SCALE KITS



Even the most comprehensive range of scales and measurement technology in some cases does not fully meet all requirements. A few weighing processes do require an individual special solution.

For this reason, we have special scale kits ready for you, with which you can realize customized solutions for your applications.

All individual parts are matched to each other and thus offers the suitable solution for every case of application.

With the SAUTER scale kits, you become even more flexible in your application possibilities and benefit from a lower order effort and a price advantage.

Would you like advice on this? Our product specialist will be happy to assist you with your inquiries and will create a personal concept together with you.



Stefan Herrmann
Product specialist
Scale kits

Tel. +49 7433 9933-214
stefan.herrmann@kern-sohn.com

Quick-Finder

Nominal load	Model	Price excl. VAT, ex works €	Page
kg	SAUTER		
300	CW 300	640,-	100
300	CW 300KFB	920,-	100
300	CW 300R	1090,-	101
300	CW 300RKFN	1490,-	101
600	CW 600R	1090,-	101
600	CW 600RKFN	1490,-	101
750	CW 750	640,-	100
750	CW 750KFB	920,-	100
1500	CW 1500	580,-	100
1500	CW 1500KFB	860,-	100
1500	CW 1500R	1200,-	102
1500	CW 1500RKFN	1610,-	102
3000	CW 3000	590,-	100
3000	CW 3000KFB	860,-	100
3000	CW 3000R	1610,-	102
3000	CW 3000RKFN	1610,-	102
4500	CW 4500	580,-	100
4500	CW 4500KFB	860,-	100
4500	CW 4500R	1200,-	102
4500	CW 4500RKFN	1610,-	102
6000	CW 6000R	1200,-	102
6000	CW 6000RKFN	1610,-	102
7500	CW 7500	680,-	100
7500	CW 7500KFB	970,-	100
9000	CW 9000	680,-	100
9000	CW 9000KFB	980,-	100
9000	CW 9000R	2890,-	102
9000	CW 9000RKFN	3290,-	102
15000	CW 15000	690,-	100
15000	CW 15000KFB	980,-	100



Illustration: series CW without display device



Illustration: series CW KFB with display device

Balance kit with type approval for individual assembly of floor scales – suitable for use in harsh industrial environments with humid environmental conditions

Features

- With SAUTER balance kits, individual weighing solutions can be put together, for example, individual balance manufacturing in industry, automotive manufacturing and agriculture. In this way, a wide range requirements in terms of dimensions, materials, combinations of peripheral devices etc. can be fulfilled. Especially suitable for the manufacturing of platform scales, funnel scales, silo scales, flush-mounted floor scales and other weighing devices. Area of use: Measuring mass as well as compressive force in harsh environments
- Details for weighing cells:
 - Accuracy in accordance with OIML R60 C3
 - CE and RoHS compliant
 - **1** Protection against dust and water splashes IP67 (in accordance with EN 60529)
 - Nickel-plated steel
 - Nominal sensitivity: 3 mV/V
 - 4-wire connection

- Junction box SAUTER CJ P4PG:
 - The robust aluminium diecast housing
 - **2** Protection against dust and water splashes IP65
- Note: Use the SAUTER CW in combination with one of our display devices, for example, KFS-TM, YKV, CE HS (see www.kern-sohn.com)

Accessories

- Assembly of components, 50 kg to 350 kg, KERN 965-412, **€ 108,-**
- Assembly of components, 350 kg to 1500 kg, KERN 965-413, **€ 130,-**
- Assembly of components, 2900 kg to 6000 kg, KERN 965-415, **€ 270,-**

Note: Powerful balances and efficient weighing systems which support you in your work, should be adapted to your individual requirements. Standard models are therefore not sufficient under some circumstances. For this reason we have special balance kits available for you, with or without display device, which you can use to create a tailor-made solution which is just right for you. In this way you can use the most varied platform sizes or individual weighing systems, e.g. within larger production plants, which match your requirements perfectly.

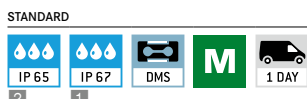

Model	Nominal load	Scope of load cells	Scope of delivery	Price excl. of VAT ex works €
SAUTER	kg			
CW 300	300	4 × CB 100-3P1		640,-
CW 750	750	4 × CB 250-3P1	- 4 Adjustable feet CE P2012	640,-
CW 1500	1500	4 × CT 500-3P2	- 4 Distance CE P3012	580,-
CW 3000	3000	4 × CT 1000-3P2	- 1 Junction box CJ P4PG	590,-
CW 4500	4500	4 × CT 1500-3P1		580,-
CW 7500	7500	4 × CT 2500-3P1	- 4 Adjustable feet CE P2018	680,-
CW 9000	9000	4 × CT 3000-3P2	- 4 Distance CE P3015	680,-
CW 15000	15000	4 × CT 5000-3P1	- 1 Junction box CJ P4PG	690,-
CW 300KFB	300	4 × CB 100-3P1		920,-
CW 750KFB	750	4 × CB 250-3P1	- 1 Display device KFB-TM	920,-
CW 1500KFB	1500	4 × CT 500-3P2	- 4 Adjustable feet CE P2012	860,-
CW 3000KFB	3000	4 × CT 1000-3P2	- 4 Distance CE P3012	860,-
CW 4500KFB	4500	4 × CT 1500-3P1	- 1 Junction box CJ P4PG	860,-
CW 7500KFB	7500	4 × CT 2500-3P1	- 1 Display device KFB-TM	970,-
CW 9000KFB	9000	4 × CT 3000-3P2	- 4 Adjustable feet CE P2018	980,-
CW 15000KFB	15000	4 × CT 5000-3P1	- 4 Distance CE P3015 - 1 Junction box CJ P4PG	980,-



Illustration: series CW RB without display device



Illustration: series CW KFNB with display device

Balance kit for individual assembly of floor scales – suitable for use in harsh industrial environments with humid environmental conditions

Features

- With SAUTER balance kits, individual weighing solutions can be put together, for example, individual balance manufacturing in agriculture or the food industry. In this way, a wide range requirements in terms of dimensions, materials, combinations of peripheral devices etc. can be fulfilled. Especially suitable for the manufacturing of platform scales, funnel scales, silo scales, weighing devices for manure spreaders in agriculture, weighing device in municipal vehicles, e.g. waste disposal or winter road services, flush-mounted floor scales and other weighing devices
- Details for weighing cells:
 - CE and RoHS compliant
 - **1** Protection against dust and water splashes IP68/IP69K
 - Stainless steel
 - 2-wire connection
 - Nominal sensitivity: 3 mV/V
- Junctionbox SAUTER CJ X467:
 - **2** Robust housing made of stainless steel with dust and spray protection to IP67
- Note: Use the SAUTER CW RB in combination with one of our display devices, for example, KFS-TM, YKV, CE HS (see www.kern-sohn.com)

Accessories

- Assembly of components, 50 kg to 350 kg, KERN 965-412, **€ 108,-**
- Assembly of components, 350 kg to 1500 kg, KERN 965-413, **€ 130,-**

Note: Powerful balances and efficient weighing systems which support you in your work, should be adapted to your individual requirements. Standard models are therefore not sufficient under some circumstances. For this reason we have special balance kits available for you, with or without display device, which you can use to create a tailor-made solution which is just right for you. In this way you can use the most varied platform sizes or individual weighing systems, e.g. within larger production plants, which match your requirements perfectly.

STANDARD

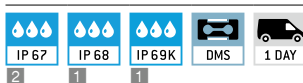

Model	Nominal load	Scope of delivery load cell	Scope of delivery	Price excl. of VAT ex works €
SAUTER	kg			
CW 300R	300	4 × CB 100-3Q1	- 1 Junctionbox CJ X467	1090,-
CW 600R	600	4 × CB 200-3Q1		1090,-
CW 300RKFN	300	4 × CB 100-3Q1	- 1 Display device KFN-TM	1490,-
CW 600RKFN	600	4 × CB 200-3Q1	- 1 Junctionbox CJ X467	1490,-



Illustration: series CW R without display device



Illustration: series CW KFN with display device

Balance kit with type approval for individual assembly of floor scales – suitable for use in harsh industrial environments with humid environmental conditions

Features

- With SAUTER balance kits, individual weighing solutions can be put together, for example, individual balance manufacturing in industry, automotive manufacturing and agriculture. In this way, a wide range requirements in terms of dimensions, materials, combinations of peripheral devices etc. can be fulfilled. Especially suitable for the manufacturing of platform scales, funnel scales, silo scales, flush-mounted floor scales and other weighing devices. Area of use: Measuring mass as well as compressive force in harsh environments
- Details for weighing cells:
 - Accuracy in accordance with OIML R60 C3
 - CE and RoHS compliant
 - **1** Protection against dust and water splashes IP68/IP69K
 - alloy steel
 - 6-wire connection
 - Nominal sensitivity: 2 mV/V

- Junctionbox SAUTER CJ X467:
 - **2** Robust housing made of stainless steel with dust and spray protection IP67
- Note: Use the SAUTER CW R in combination with one of our display devices, for example, KFS-TM, YKV, CE HS (see www.kern-sohn.com)

Accessories

- Assembly of components, 350 kg to 1500 kg, KERN 965-413, **€ 130,-**
- Assembly of components, 2900 kg to 6000 kg, KERN 965-415, **€ 270,-**

Note: Powerful balances and efficient weighing systems which support you in your work, should be adapted to your individual requirements. Standard models are therefore not sufficient under some circumstances. For this reason we have special balance kits available for you, with or without display device, which you can use to create a tailor-made solution which is just right for you. In this way you can use the most varied platform sizes or individual weighing systems, e.g. within larger production plants, which match your requirements perfectly.

STANDARD

IP 67	IP 68	IP 69K	DMS	1 DAY
2	1	1		

Model	Nominal load kg	Scope of delivery Load cells	Scope of delivery	Price excl. of VAT ex works €
SAUTER				
CW 1500R	1500	4 × CT 500-3Q1		1200,-
CW 3000R	3000	4 × CT 1000-3Q1	- 4 Distance CE P3012	1610,-
CW 4500R	4500	4 × CT 1500-3Q1	- 4 Adjustable feet CE RQ12	1200,-
CW 6000R	6000	4 × CT 2000-3Q1	- 1 Junction box CJ X467	1200,-
CW 9000R	9000	4 × CT 3000-3Q1	- 4 Distance CE P3015 - 4 Adjustable feet CE RQ35917 - 1 Junction box CJ X467	2890,-
CW 1500RKFN	1500	4 × CT 500-3Q1	- 1 Display device KFN-TM	1610,-
CW 3000RKFN	3000	4 × CT 1000-3Q1	- 4 Adjustable feet CE RQ12	1610,-
CW 4500RKFN	4500	4 × CT 1500-3Q1	- 4 Distance CE P3015	1610,-
CW 6000RKFN	6000	4 × CT 2000-3Q1	- 1 Junction box CJ X467	1610,-
CW 9000RKFN	9000	4 × CT 3000-3Q1	- 1 Display device KFN-TM - 4 Distance CE P3012 - 4 Adjustable feet CE RQ35917 - 1 Junction box CJ X467	3290,-

Accredited calibration with DAkkS calibration certificate for force gauges

The KERN calibration laboratory is at your side when you need to calibrate DAkkS reliably.

From the transducer to the full measuring chain, we are happy to take care of traceable calibration of your test equipment for you. Our accreditation includes the calibration of tensile and compressive force up to 5 kN according to the standards DIN EN ISO 376 and DKD-R 3-3, each with the Newton (N) display unit for a complete measuring chain (situation A) or voltage ratio/transmission coefficient (mV/V, situation B). Below you will find a comparison of which standard meets which criteria:

Comparison of DIN EN ISO 376 and DKD-R 3-3

	ISO 376	DKD-R 3-3
Standardization	ISO standard (internationally standardized)	Standard of the DKD (Germany)
Measuring equipment	Force transducers and complete measuring chains	Force transducers and complete measuring chains
Area of application	Specifically force gauges for the testing of testing equipment	General force gauges
Number of power stages	8	5
Classification/Assessment	Classification in classes 00; 0,5; 1 and 2	None in standard
Test sequences	Fixed procedure	Processes A, B, C and D possible. Standard is A; B, C and D are reduced processes, corresponding previous knowledge is necessary
Summary	Higher-quality calibration, as 8 force levels are calibrated	High-quality calibration, reduced sequences with less effort possible

Prices for DAkkS calibration of force gauges and force transducers

Situation A: Force transducer (voltage ratio, in mV/V)^{*1,2}

ISO 376 (8 stages)			DKD-R 3-3 (5 stages, sequence A)		
KERN	Measuring range	Price € ex works excl. of VAT	KERN	Measuring range	Price € ex works excl. of VAT
Tensile force:					
963-161IV (R)	≤ 500 N	225,-	963-161V (R)	≤ 500 N	210,-
963-162IV (R)	≤ 2 kN	270,-	963-162V (R)	≤ 2 kN	250,-
963-163IV (R)	≤ 5 kN	350,-	963-163V (R)	≤ 5 kN	325,-
Compression force:					
963-261IV (R)	≤ 500 N	225,-	963-261V (R)	≤ 500 N	210,-
963-262IV (R)	≤ 2 kN	270,-	963-262V (R)	≤ 2 kN	250,-
963-263IV (R)	≤ 5 kN	350,-	963-263V (R)	≤ 5 kN	325,-
Tensile and Compression force:					
963-361IV (R)	≤ 500 N	375,-	963-361V (R)	≤ 500 N	350,-
963-362IV (R)	≤ 2 kN	450,-	963-362V (R)	≤ 2 kN	420,-
963-363IV (R)	≤ 5 kN	600,-	963-363V (R)	≤ 5 kN	550,-

Situation B: Complete force gauge (in N)^{*2}

ISO 376 (8 stages)			DKD-R 3-3 (5 stages, sequence A)		
KERN	Measuring range	Price € ex works excl. of VAT	KERN	Measuring range	Price € ex works excl. of VAT
Tensile force:					
963-161I (R)	≤ 500 N	186,-	963-161 (R)	≤ 500 N	168,-
963-162I (R)	≤ 2 kN	225,-	963-162 (R)	≤ 2 kN	205,-
963-163I (R)	≤ 5 kN	310,-	963-163 (R)	≤ 5 kN	285,-
Compression force:					
963-261I (R)	≤ 500 N	186,-	963-261 (R)	≤ 500 N	168,-
963-262I (R)	≤ 2 kN	225,-	963-262 (R)	≤ 2 kN	205,-
963-263I (R)	≤ 5 kN	310,-	963-263 (R)	≤ 5 kN	285,-
Tensile and Compression force:					
963-361I (R)	≤ 500 N	335,-	963-361 (R)	≤ 500 N	305,-
963-362I (R)	≤ 2 kN	415,-	963-362 (R)	≤ 2 kN	375,-
963-363I (R)	≤ 5 kN	560,-	963-363 (R)	≤ 5 kN	500,-

(R): Recalibration

For each force gauge without interface or from other manufacturers we charge a surcharge of € 10,- for the additional effort.

^{*1} Compatibility with our amplifiers required

^{*2} Installation in our measuring equipment required

Factory calibration for force

Situation A: Force transducer (voltage ratio, in mV/V)* ^{1,2}			Situation B: Complete force gauge (in N)* ²		
KERN	Measuring range	Price € ex works excl. of VAT	KERN	Measuring range	Price € ex works excl. of VAT
Tensile force:					
961-161V (R)	≤ 500 N	210,-	961-161 (R)	≤ 500 N	168,-
961-162V (R)	≤ 2 kN	250,-	961-162 (R)	≤ 2 kN	205,-
961-163V (R)	≤ 5 kN	325,-	961-163 (R)	≤ 5 kN	285,-
961-164V (R)	≤ 20 kN	415,-	961-164 (R)	≤ 20 kN	370,-
961-165V (R)	≤ 50 kN	415,-	961-165 (R)	≤ 50 kN	370,-
961-166V (R)	≤ 120 kN	445,-	961-166 (R)	≤ 120 kN	410,-
961-167V (R)	≤ 250 kN	445,-	961-167 (R)	≤ 250 kN	410,-
Compression force:					
961-261V (R)	≤ 500 N	210,-	961-261 (R)	≤ 500 N	168,-
961-262V (R)	≤ 2 kN	250,-	961-262 (R)	≤ 2 kN	205,-
961-263V (R)	≤ 5 kN	325,-	961-263 (R)	≤ 5 kN	285,-
961-264V (R)	≤ 20 kN	415,-	961-264 (R)	≤ 20 kN	370,-
961-265V (R)	≤ 50 kN	415,-	961-265 (R)	≤ 50 kN	370,-
961-266V (R)	≤ 120 kN	445,-	961-266 (R)	≤ 120 kN	410,-
961-267V (R)	≤ 250 kN	445,-	961-267 (R)	≤ 250 kN	410,-
Tensile and Compression force:					
961-361V (R)	≤ 500 N	350,-	961-361 (R)	≤ 500 N	305,-
961-362V (R)	≤ 2 kN	420,-	961-362 (R)	≤ 2 kN	375,-
961-363V (R)	≤ 5 kN	550,-	961-363 (R)	≤ 5 kN	500,-
961-364V (R)	≤ 20 kN	590,-	961-364 (R)	≤ 20 kN	550,-
961-365V (R)	≤ 50 kN	590,-	961-365 (R)	≤ 50 kN	550,-
961-366V (R)	≤ 120 kN	650,-	961-366 (R)	≤ 120 kN	600,-
961-367V (R)	≤ 250 kN	650,-	961-367 (R)	≤ 250 kN	600,-

(R): Recalibration

For each force gauge without interface or from other manufacturers we charge a surcharge of € 10,- for the additional effort.

*1 Compatibility with our amplifiers required

*2 Installation in our measuring equipment required

Factory calibration certificates

As DAkkS calibration certificates cannot be offered for all measuring devices or measurement sizes, or where it is not customary, we then offer factory calibration certificates. These calibrations are carried out according to in-house specifications and are available for many measuring instruments, such as:

- Mechanical balances (spring balances, etc.)
- Force-measuring devices up to 250 kN
- Measuring devices for layer thickness 0 µm – 2000 µm
- Hardness testing devices in accordance with Leeb tests
- Ultrasonic material thickness testing device 25 mm – 300 mm

We carry out calibrations independent of brand. In order to avoid any unnecessary delays when processing your order, please send us the technical documents and necessary accessories with the checking device. Calibration time 4 working days.

For up-to-date information on test services for further measuring sizes, please visit our website www.kern-lab.com

Factory calibration certificates

KERN	Physical unit	Measuring range	Price excl. of VAT ex works €
Factory calibration			
961-102K	Force (for digital dynamometer KERN MAP)	≤ 130 kg	150,-
961-110	Coating thickness	≤ 2000 µm F or N	150,-
961-112	Coating thickness	≤ 2000 µm FN	210,-
961-113	Wall thickness (ultra sound)	≤ 300 mm (in stainless steel)	150,-
961-114	Wall thickness (Test blocks)	≤ 300 mm	187,-
961-170	Hardness comparison plate (Shore)	For sets up to 7 plates	119,-
961-131	Hardness tester (Leeb)	400 – 800 HLD	150,-
961-132	Hardness comparison plate (Leeb)	Hardness comparison plate (for Leeb durometer)	150,-
961-270	Hardness (UCI)	200 – 800 HV	325,-
961-150	Length	≤ 300 mm	150,-
961-190	Light	≤ 200000 lx	205,-
961-100	Mass (Mechanical balances/ spring balances)	≤ 5 kg	89,-
961-101	Mass (Mechanical balances/ spring balances)	> 5 – 50 kg	110,-
961-102	Mass (Mechanical balances/ spring balances)	> 50 – 350 kg	131,-
961-103	Mass (Mechanical balances/ spring balances)	> 350 – 1500 kg	205,-
961-120	Torque wrench test devices	1 Nm – 200 Nm	210,-
Additional services			
962-116	Express service with 48 hour delivery		52,-/ instrument