

KERN Pictograms

 Internal adjusting: Quick setting up of the balance's accuracy with internal adjusting weight (motordriven)	 Network interface: For connecting the scale to an Ethernet network	 Suspended weighing: Load support with hook on the underside of the balance
 Adjusting program CAL: For quick setting up of the balance's accuracy. External adjusting weight required	 KERN Communication Protocol (KCP): It is a standardized interface command set for KERN balances and other instruments, which allows retrieving and controlling all relevant parameters and functions of the device. KERN devices featuring KCP are thus easily integrated with computers, industrial controllers and other digital systems	 Battery operation: Ready for battery operation. The battery type is specified for each device
 Easy Touch: Suitable for the connection, data transmission and control through PC or tablet.	 GLP/ISO log: The balance displays weight, date and time, independent of a printer connection	 Rechargeable battery pack: Rechargeable set
 Memory: Balance memory capacity, e.g. for article data, weighing data, tare weights, PLU etc.	 GLP/ISO log: The balance displays weight, date and time, independent of a printer connection	 Universal plug-in power supply: with universal input and optional input socket adapters for A) EU, CH, GB B) EU, CH, GB, USA C) EU, CH, GB, USA, AUS
 Alibi memory: Secure, electronic archiving of weighing results, complying with the 2014/31/EU standard.	 GLP/ISO log: With weight, date and time. Only with KERN printers.	 Plug-in power supply: 230V/50Hz in standard version for EU, CH. On request GB, USA or AUS version available
 KERN Universal Port (KUP): allows the connection of external KUP interface adapters, e.g. RS-232, RS-485, SB, Bluetooth, WLAN, Analogue, Ethernet etc. for the exchange of data and control commands, without installation effort	 Piece counting: Internal memory for complete recipes with name and target value of the recipe ingredients. User guidance through display	 Integrated power supply unit: Integrated in balance. 230V/50Hz standard EU. More standards e.g. GB, USA or AUS on request
 Data interface RS-232: To connect the balance to a printer, PC or network	 Recipe level A: The weights of the recipe ingredients can be added together and the total weight of the recipe can be printed out	 Weighing principle: Strain gauges Electrical resistor on an elastic deforming body
 RS-485 data interface: To connect the balance to a printer, PC or other peripherals. Suitable for data transfer over large distances. Network in bus topology is possible	 Recipe level B: Internal memory for complete recipes with name and target value of the recipe ingredients. User guidance through display	 Weighing principle: Tuning fork A resonating body is electromagnetically excited, causing it to oscillate
 USB data interface: To connect the balance to a printer, PC or other peripherals	 Totalising level A: The weights of similar items can be added together and the total can be printed out	 Weighing principle: Electromagnetic force compensation Coil inside a permanent magnet. For the most accurate weighings
 Bluetooth* data interface: To transfer data from the balance to a printer, PC or other peripherals	 Percentage determination: Determining the deviation in % from the target value (100 %)	 Weighing principle: Single cell technology: Advanced version of the force compensation principle with the highest level of precision
 WiFi data interface: To transfer data from the balance to a printer, PC or other peripherals	 Weighing units: Can be switched to e.g. nonmetric units. See balance model. Please refer to KERN's website for more details	 Verification possible: The time required for verification is specified in the pictogram
 Control outputs (optocoupler, digital I/O): To connect relays, signal lamps, valves, etc.	 Weighing with tolerance range: (Checkweighing) Upper and lower limiting can be programmed individually, e.g. for sorting and dosing. The process is supported by an audible or visual signal, see the relevant model	 DAkKS calibration possible (DKD): The time required for DAkKS calibration is shown in days in the pictogram
 Analogue interface: to connect a suitable peripheral device for analogue processing of the measurements	 Hold function: (Animal weighing program) When the weighing conditions are unstable, a stable weight is calculated as an average value	 Factory calibration (ISO): The time required for Factory calibration is shown in days in the pictogram
 Interface for second balance: For direct connection of a second balance	 Protection against dust and water splashes IPxx: The type of protection is shown in the pictogram.	 Package shipment: The time required for internal shipping preparations is shown in days in the pictogram
		 Pallet shipment: The time required for internal shipping preparations is shown in days in the pictogram

KERN – Measuring technology and testing services from a single source



Balances & Test service catalogue

Provides a complete overview of the KERN line of balances, test weights, and services such as verification, calibration, etc.

Medical scales catalogue

Complete line of medical scales, from infant scales to patient scales, chair scales and adiposity scales, as well as hand grip dynamometers, chemist's balances and veterinary scales.

Microscopes & Refractometers catalogue

Extensive range in the area of optical instruments, such as, biological microscopes, stereo microscopes, metallurgical microscopes, polarisation microscopes as well as analogue and digital refractometers.

SAUTER measuring equipment catalogue

Test instruments for industry and commerce, such as force, coating thickness, material thickness and calibration service.

Test service brochure

Detailed information on topics pertaining to the calibration and verification of balances, test weights, and force measuring devices.

Your advantages

fast

- 24 hours delivery service for products in stock – ordered today, on its way tomorrow
- Sales & service hotline available from 8:00 am to 6:00 pm

reliable

- Up to 3 years warranty
- Precision in weighing technology for more than 175 years

competent

- DAkKS accreditation
DIN EN ISO/IEC 17025
- Certified QM system
DIN EN ISO 9001
- Authorisation for initial verification by the manufacturer 2014/31/EU
- Medical certifications
DIN EN ISO 13485 and 93/42/EWG

versatile

- One-stop shopping: from pocket balances through to 12 t crane balance – everything from one supplier
- Find the product you want at lightning speed with the "Balance Quick-Finder" at www.kern-sohn.com

 **Order hotline**
+49 7433 9933-0

 **Service hotline**
+49 7433 9933-199

 **Calibration hotline**
+49 7433 9933-196

 **Online Shop**
www.kern-sohn.com

 **E-mail order**
info@kern-sohn.com

 **Our team of consultants will assist you**
from Monday to Friday
from 8:00 am to 5:00 pm

Keyword index

A	
Adiposity scales	see website
Accessories	169-181
Alibi memory	223
Aluminium sample plate	49-52
Analogue refractometer	see website
Analytical balances	38-48
Animal scales	57-58, 64-65, 72-73, 97-110, 113-126, 159-162

B	
Baby scales	see website
Bench scales	53-60
Bluetooth/RS-232 Adapter	177
Body fat scales	see website

C	
Calibration Service	210-222
Carat balances	13, 17, 26-37, 39-44, 46-48
Catalogues, Brochures, Flyer	2, 226
Chair scales	see website
Chair weighers	see website
Coating thickness gauges	see website
Column	179
Control of checking equipment	210-222, 225
Counting scales	78-92
Counting systems	88-91
Crane scales	163-168

D	
DakKS/DKD	210-222
Density determination	13-14, 22-23, 25, 27-28, 30-32, 36-41, 98
Display devices	130, 140-141
Drive-through scale	124-126
Drying balance	49-52

E	
Earth's gravitational force	224
EasyTouch App	132-135
Equipment qualification	211
Ethernet/RS-232 Adapter	176
Explosion hazard	226

F	
Factory calibration	211, 221-222
Floor scales	101-126
Foot switch	26, 73, 110
Force gauges	see website

G	
Grain balances	see website
Glossary	223-225

H	
Handrail scales	see website
Hanging scales	156-168
Hardness tester	see website
Height rods	see website
Hydrostatic balances	16-17, 24-25, 27, 30-31, 33, 35, 40-44, 46-48, 107

I	
Industrial scales	53-155
Information	223-226
Interface cable	173
Ioniser	39-44, 180
IP 65...68 protected scales	65-73, 108, 123, 126
ISO calibration	211, 221-222

J	
Junction box	153

K	
Kitchen scales	63

L	
Laboratory balances	14-52
Length measuring devices	see website
Lexicon	223-225
Load cells	146-152
Luggage scale	158

M	
Material thickness gauge	see website
Load cells	146-152
Mechanical balances (spring balances)	see website
Medical scales	see website
Microscopes, biological	see website
Microscopes, metallurgical	see website
Microscopes, polarisation	see website
Microscopes, stereo	see website
Minimum sample weight	215
Mobile pallet weigher	154-155
Moisture analysers	49-52

P	
Pallet scales	120-123
Personal floor scales	see website
Personal scales	see website
Pictogram overview	2
Platform scales	93-110
Platforms	128, 131, 142-145
Plummet, density determination	179
Pocket balances	11-13
Power supply adapter set	178
Pre-packaging legislation (FPVO)	224
Precious stones plate	32, 39
Precision balances	20-37
PREMIUM+ WEIGHTS	183
Price computing scales	74-77
Printers	170-172
Protective dust cover	179

R	
Recalibration	214, 218
Refractometers, digital	see website
Retail balances	74-77
Roller conveyor	181
Round fiberglass filter	50-52
RS-232/Bluetooth-Adapter	177
RS-232/Ethernet-Adapter	176
RS-232/USB-Adapter	178
RS-232/WiFi-Adapter	176

S	
Safety Set	184
Semi-micro balances	40/41, 44, 46-48
Shop balances	74-77
Signal lamp	178
Software	132-135, 174-175
Spring balances	see website
Stainless steel scales	65-67, 69-73, 108-110, 118, 123, 126

T	
Tare pan	179
Temperature calibration set	49-52
Tensile force measurement device	164-165
Terminals	130, 140-141
Test service	210-222
Test stands	see website
Test weights	189-209
Touchscreen scales	132-135
Tweezers	205

U	
Underfloor weighing, accessories	16-17, 24-25, 30-32, 36, 40-44, 46-48, 85, 87, 107

V	
Verification	219, 223
Verification plug	104-105, 114-115, 121

W	
Weighing beams	119
Weighing bridges	142-145
Weighing Systems Industry 4.0	128-131
Weighing table	180
Weighing transmitter, digital	129
Wheelchair platform scales	see website
WiFi/RS-232 Adapter	176

Product group index 2023

01 Pocket balances
11 – 13



02 School balances
14 – 19



03 Precision balances
20 – 37



04 Analytical balances
38 – 48



05 Moisture analysers
49 – 52



06 Bench scales
53 – 60



07 Food (kitchen/stainless steel/IP65...68 protection)
61 – 73



08 Price computing scales
74 – 77



09 Counting scales/
Counting systems
78 – 92



10 Parcel scales/
Platform scales
93 – 110



11 Floor scales/Pallet scales
/Drive-through scales
111 – 126



12 Weighing Systems
Industry 4.0/EasyTouch
127 – 135



13 Display devices/Platforms
/Weighing bridges/
Load cells
136 – 153



14 Pallet truck scales
154 – 155



15 Hanging scales/
Crane scales
156 – 168



16 Accessories
169 – 181



17 Test weights
182 – 209



18 DAkkS Calibration Service
/Verification service
210 – 222



Do you have questions about our products? Our customer consultants will be pleased to assist you:

UK, IE, IS, FR, Maghreb, BE, LUX



Maren Möwert
Customer support
Tel. +49 7433 9933-132
Mobil +49 151 46143240
maren.moewert@kern-sohn.com

UK, IE IS



Rebecca Schäfer
Back Office
Tel. +49 7433 9933-119
rebecca.schaefer@kern-sohn.com

BE, LUX



Kerstin Schweitzer
Back Office
Tel. +49 7433 9933-289
kerstin.schweitzer@kern-sohn.com

DK, SE, FI, NO, PL, LV, LT, EE



Mark Hauder
Customer support
Tel. +49 7433 9933-310
Mobil +49 160 3378426
mark.hauder@kern-sohn.com



Rebecca Schäfer
Back Office
Tel. +49 7433 9933-119
rebecca.schaefer@kern-sohn.com

GR, CY, BG, HU, RO, SK, CZ, AL, Ex-Yugoslavia, GUS



Ariana Sevcenco
Customer support
Tel. +49 7433 9933-203
Mobil +49 151 72434692
ariana.sevcenco@kern-sohn.com



Kassiani Chasioti
Back Office
Tel. +49 7433 9933-153
kassiani.chasioti@kern-sohn.com

North America, Near- & Middle East, Africa, Asia, Oceania, TR



Corinna Matthes
Customer support
Tel. +49 7433 9933-215
Mobil +49 151 44568364
corinna.matthes@kern-sohn.com



Corinna Matthes
Back Office
Tel. +49 7433 9933-215
Mobil +49 151 44568364
corinna.matthes@kern-sohn.com

Technical Service



Daniel Egeler
Tel. +49 7433 9933-199
daniel.egeler@kern-sohn.com



Sven Göggel
Tel. +49 7433 9933-199
goeggel@kern-sohn.com

DAkKS Calibration Service Test weights



Waldemar Fleitling
Tel. +49 7433 9933-163
fleitling@kern-sohn.com



Karl-Richard Fuchs
Tel. +49 7433 9933-136
fuchs@kern-sohn.com

DAkKS Calibration Service Balances & Measuring instruments

Board of Management



Albert Sauter
Tel. +49 7433 9933-157
albert.sauter@kern-sohn.com



Jutta Osswald
Tel. +49 7433 9933-159
jutta.osswald@kern-sohn.com

Accountancy

Sales & Marketing Manager



Stephan Ade
Tel. +49 7433 9933-121
Mobil +49 171 3060086
ade@kern-sohn.com



Hendrik Neff
Tel. +49 7433 9933-161
Mobil +49 171 3059946
hendrik.neff@kern-sohn.com

Team Manager Printdesign & CRM



Katharina Faradacco
Tel. +49 7433 9933-192
katharina.faradacco@kern-sohn.com

Laboratory



Sales department

Aleksandar Delić
Tel. +49 7433 9933-120
Mobil +49 151 11196197
aleksandar.delic@kern-sohn.com

Industry



Sales department

Florian Bächle
Tel. +49 7433 9933-118
Mobil +49 151 44611168
florian.baechle@kern-sohn.com

Medical Sector



Sales department

Julia Sauter
Tel. +49 7433 9933-168
Mobil +49 151 72838959
julia.sauter@kern-sohn.com

Test Weights



Sales department

Taras Mikitisin
Tel. +49 7433 9933-143
Mobil +49 171 5590115
mikitisin@kern-sohn.com

Food



Sales department

Riccardo Spataro
Tel. +49 7433 9933-147
Mobil +49 151 46143234
riccardo.spataro@kern-sohn.com

Software KERN EasyTouch



Sales department

Ina Reger
Tel. +49 7433 9933-218
ina.reger@kern-sohn.com

KERN Hotlines

+49 7433 9933- ...

Service hotline	199	for general technical questions about your KERN or SAUTER product
System solutions Industry 4.0	200	for all technical questions concerning the interlocking of the latest information and communication technology with our scales, load cells and measuring devices as well as questions about KERN software
Industrial scales	333	for all technical questions concerning our basic scales (laboratory & industry), pocket balances, school balances, bench scales, price-computing scales, platform scales, counting scales, counting systems, floor scales, pallet truck scales, crane scales
Laboratory and analytical balances	444	for all technical questions concerning our high quality precision balances, analytical balances (especially with electromagnetic force-compensated measuring systems, tuning fork and high application density)
Medical scales	499	for all technical questions concerning our baby scales, personal scales, handrail scales, chair scales, wheelchair scales, dynamometers
SAUTER measuring instruments	555	for all technical questions concerning our SAUTER measuring instruments, test benches, force measuring accessories (clamps etc.), SAUTER software
Moisture analysers	599	for all technical questions concerning our moisture analysers
Optical devices	777	for all technical questions concerning our microscopes, microscope cameras, refractometers, etc.
EasyTouch Hotline	322	for all technical questions about the installation and commissioning of the EasyTouch software
EasyTouch Presale	324	for general questions and information about the EasyTouch software

WHEN DESIGN MEETS PERFORMANCE

May we introduce...? The new models from the KERN IoT Line are celebrating their debut.

Together we can enjoy the shared, advanced-looking KERN design, the consistent and simplified handling, the high connectivity level, and a persuasive performance that operates across all devices.



Dive into our new KERN brand universe.



Design

- + Trend-setting, high-quality KERN design
- + Recognisability through uniform product range
- + Reliable brand values are reflected visually and functionally in the product



Performance

- + Cross-device functionality and protocols
- + Consistently reliable performance
- + The latest technologies
- + Cross-device functionality and protocols



Philosophy

- + Sustainable due to high energy efficiency
- + Standardisation of design components across all units
- + Controlled value chain
- + Tested and monitored technology for maximum user safety



Are you curious about the models in the KERN IoT range and what opportunities they offer?

Then take a look at pages 8/9, because thanks to new technologies such as KUP and KCP these models are perfectly equipped for the wide range of challenges of Industry 4.0



User Interface

- + Uniform, simplified user guidance
- + Problem-free commissioning, use and expansion
- + Cross-model software



Service

- + Fast and competent help from our IoT specialists
- + Even more efficient repair process
- + Accessories can be flexibly combined

Note: Our KERN IoT accessories can be easily combined with all our IoT models.

Find the right printer and other practical accessories on page 169 or in our online shop www.kern-sohn.com

ARE YOU READY?

With the KERN Universal Port (KUP) and the KERN Communication Protocol (KCP) we ensure the perfect integration of your KERN balance into production or process chains for a complete, simplified work process.

Our products will make sure you are prepared for the future of weighing in the Internet of Things. Get IoT ready – with the IoT models from KERN.



KERN Universal Port (KUP)

The integrated KERN Universal Port (KUP) allows the connection of external KUP interface adapters such as RS-232, USB, Bluetooth, WiFi, Analogue, Ethernet etc.

The outstanding advantage here is that the KUP interface adapters are simply plugged in, i.e. retrofitting interfaces is conveniently possible without opening the scale housing or complicated installation.

The interface adapters enable convenient transmission of weighing data to networks, PCs, smartphones, tablets, laptops, printers etc. In addition, control commands and data inputs can also be sent to the scale via the connected devices.

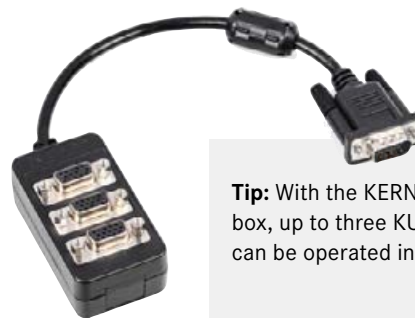
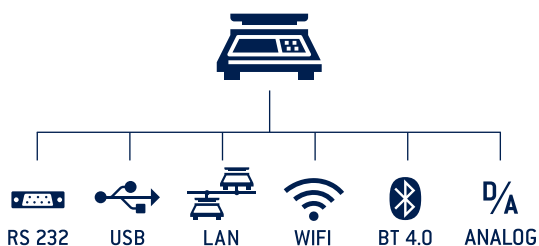

Tip: With the KERN KUP-13 extension box, up to three KUP interface adapters can be operated in parallel on the scale.

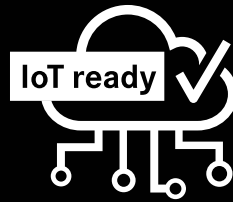

KERN Communication Protocol (KCP)

The KERN Communication Protocol (KCP) permits searching and remote control of the balance through external control devices or computers using the KERN Communication Protocol. KCP is a standardised interface command structure for KERN balances and other measuring instruments which allows you to recall and manage all relevant parameters and device functions. You can therefore simply connect KERN models with KCP to computers, industrial control systems and other digital systems.

In a large number of cases the KERN Communication Protocol is compatible with the MT-SICS protocol. KCP is available through all KUPs, and on the KERN KIB-TM display device through the interfaces available.

KCP – EXPORT („OUTBOUND“) – THE HIGHLIGHTS

- Stable, immediate weight
- Live transfer of weights
- Storing of gross weight, tare weight, net weight, stability, date, time etc., in the tamper-proof Alibi memory
- Output of the weighing result in percent
- Output of the weighing result in pieces (piece-counting function)
- Output of the weight at freely-definable timed intervals
- and much more

KCP – IMPORT („INBOUND“) – THE HIGHLIGHTS

- Recall of the central device data
- Setup or recall of an individual device ID number
- Setting or searching for a tare value (pre-tare value) externally
- Recall of stored weighing results from the alibi memory
- Carrying out external adjustment/linearization
- Setting the reference values in the balance externally and outputting the weighing result in percent or in pieces
- Setting a network address for the balance (IP) – also for WiFi
- and much more

Still got questions?

We will be happy to give you more comprehensive information on this topic – talk to us:

Hotline +49 7433 9933-0
www.kern-sohn.com

NEW IN → 2023

Innovative technology, stunning performance, improved features – all in proven KERN quality. You can see all our new additions in 2023 here – come and be inspired.



The born stacker – happily comes back to school

→ KERN EFS SCHOOL BALANCE

The uncomplicated companion for all school laboratories and other educational institutions. Easy handling, durable and robust, it can cope well with changing users. With its tremendous weighing range, it is a typical nerd and without a doubt at the top of its class. For details, see page 15



First Class products in an IP-protected stainless steel housing

→ KERN PWS PRECISION BALANCE

Resistant to fine particles and water splashes, withstands high loading. Let its high performance for reliable, high precision measurements impress you.

For details, see page 34



Proven KERN models – now with a facelift!

Proven KERN models – now with a facelift! These KERN models feature plenty of improved technology (IoT, KUP) and a refreshed KERN look:

→ KERN PCB PRECISION BALANCE
For details, see page 26/27

→ KERN 572 PRECISION BALANCE
For details, see page 30

→ KERN CKE COUNTING BALANCE
For details, see page 85

→ KERN CDS COUNTING BALANCE
For details, see page 87

→ KERN IOC PLATFORM SCALES
For details, see page 104/105

→ KERN DS PLATFORM SCALES
For details, see page 107



High-capacity precision balances with password-protected user administration

→ KERN FES/FEJ PRECISION BALANCE

With this robust allrounder you are particularly well-equipped for the pharmaceutical industry. Here you can easily allocate and manage different users.

For details, see page 37



Our Flagship – now with fully automatic doors

→ KERN ABP-A ANALYTICAL BALANCE

Our KERN Showcase model now features a super practical innovation, making your daily laboratory life easier—singlehandedly. For details, see page 47/48



→ IoT-ready models (with KUP) carry this icon

01

POCKET BALANCES































Pocket size precision

Pocket balances are the ideal helpers whenever mobility and high precision are required. Since they have fewer keys, operation is simple and fast. Different weighing units stored in the pocket balance, such as g, oz, ct, gn, etc., make them universally usable. An integrated calculator allows you to use the measured weight immediately in calculations, to e.g. determine a price, quantity, average value and much more. Compact in size and well protected with a flap or protective cover, which can be used as a convenient taring container, the pocket balance is always a useful tool for mobile weighing.

- In production, to control of production weights or during the picking of small parts
- In quality control for the quick testing of small parts like plastic parts from injection moulding machines, milled parts, screws, etc.
- For mobile weighing, on-site sampling, and fast analysis wherever there's no power outlet
- In hobbies and sports, e.g. when filling black powder, weighing parts from modelling kits etc.
- In commerce, for the fast determination of the weights of coins, jewellery, precious stones, etc.
- In veterinary sector for the weighing of small animals, the mixing of food, etc.
- In the food sector for the preparation of spice or tea mixes, for the weighing of food in line with a diet sheet

Quick-Finder Pocket balances

Readability [d] g	Weighing capacity [Max] g	Model KERN	Price excl. of VAT ex works €	Page	 DAYS	 CAL EXT	 UNIT	 BATT
For an explanation on the pictos, see front flap								
0,001	50	TGD 50-3CS05 	295,-*	13	1			
0,01	60	CM 60-2N	93,-	12	1			
0,01	150	TGC 150-2S05	107,-*	13	1			
0,1	150	CM 150-1N	60,-	12	1			
0,1	320	CM 320-1N	63,-	12	1			
0,1	500	TGC 500-1S05	107,-*	13	1			
1	1000	CM 1K1N	60,-	12	1			
1	1000	TGC 1K-3S05	107,-*	13	1			

*Price set of 5 units

 = Carat balances

 = standard

 = option



KERN CM

Pocket balance with integrated pocket calculator

STANDARD				OPTION
CAL EXT	UNIT	BATT	1 DAY	+3 DAYS

- Simple and convenient 4-key operation
- Hard case cover as protection against pressure and dust
- Robust, handy, well-protected
- Integrated calculator

Note

KERN pocket balances also excellent as a gift for your customers or for personalised marketing and sales campaigns. We will be happy to add your logo to the cover, the lid or the packaging, up from quantities of 100 items. Please ask for details.

KERN	CM 60-2N	CM 150-1N	CM 320-1N	CM 1K1N
Weighing capacity [Max] g	60 g	150 g	320 g	1000 g
Readability [d]	0,01 g	0,1 g	0,1 g	1 g
LCD display	backlit, digit height 12 mm			
Dimensions of weighing plate	W×D 70×80 mm			
Overall dimensions	W×D×H 85×130×25 mm			
Power supply	Batteries included with delivery, 2×1,5 V AAA, AUTO-OFF function to preserve battery life, operating time up to 33 h			
Net weight	0,20 kg			
Permissible ambient temperature	5 °C/35 °C			
Price €, excl. of VAT, ex works	93,-	60,-	63,-	60,-
Option DAkkS Calibr. Certificate	963-127, 93,-			



KERN TGC

Slim pocket balance with large stainless steel weighing plate and practical tare pan



KERN TGD

Compact pocket carat balance for precision weighing of jewellery and precious stones

STANDARD

CAL EXT UNIT BATT 1 DAY

OPTION

DAkKS +3 DAYS

- High-resolution pocket balance with particularly rapid reaction and stabilisation time, which means that you can work extremely efficiently
- Particularly flat design
- 1 Cover made of shock proof plastic as protection against pressure and dust. Can also be used as a tare cup
- Stainless steel weighing plate, which makes cleaning easy and hygienic
- **Note:** The models are delivered in a set of 5 units. That means the prices given in the table refer to 5 units. Cannot be delivered individually. The calibration prices given here refer to calibration of a single balance

STANDARD

CAL EXT UNIT BATT 1 DAY

OPTION

DAkKS +3 DAYS

- Simple and convenient 4-key operation
- Can be switched over from g to ct, gn, dwt, ozt, oz at the touch of a key
- Innovative touchscreen: Large touch-sensitive, backlit touch display with very good contrast for easy operation and convenient reading
- Hard case cover as protection against pressure and dust
- Stainless steel weighing plate, which makes cleaning easy and hygienic
- Weighing pan standard
- Powder scale with Grain division (gn), ideal for sport shooters, reloaders etc. for self-filling cartridge cases
- USB cable for power supply as standard
- 2 Delivered in single design packaging
- **Note:** The models are delivered in a set of 5 units. That means the prices given in the table refer to 5 units. Cannot be delivered individually. The calibration prices given here refer to calibration of a single balance

Note

KERN pocket balances also excellent as a gift for your customers or for personalised marketing and sales campaigns. We will be happy to add your logo to the cover, the lid or the packaging, up from quantities of 100 items. Please ask for details.

KERN	TGC 150-2S05	TGC 500-1S05	TGC 1K-3S05	TGD 50-3CS05
Weighing capacity [Max] g	150 g	500 g	1000 g	50 g 250 ct
Readability [d]	0,01 g	0,1 g	1 g	0,001 g 0,005 ct
LCD display	backlit, digit height 12 mm			backlit, digit height 20 mm
Dimensions of weighing plate	ø 81 mm			ø 65 mm
Overall dimensions	W×D×H 100×130×18 mm			W×D×H 96×149×36 mm
Power supply	Batteries included with delivery, 2× CR2032, operating time up to 33 h			Batteries included with delivery, 4×1,5 V AAA, operating time up to 150 h without backlight
Net weight	1 kg (set of 5 units)			1 kg (set of 5 units)
Permissible ambient temperature	0 °C/40 °C			5 °C/35 °C
Price € , excl. of VAT, ex works	107,-*	107,-*	107,-*	295,-*
Option DAkKS Calibr. Certificate	963-127, 93,-			963-127, 93,-

*Price set of 5 units excl. of VAT exworks

02

SCHOOL BALANCES



As entry-level models, KERN school balances cover the most important basic applications of laboratory balances and offer simple operation, easy readability and an optimal price-performance ratio. The KERN School balances can be used flexibly and independent of location thanks to battery operation and are therefore the ideal choice for school or teaching purposes.

Our recommendation: the brand new EFS school balance in our product range, a space-saving and inexpensive allrounder for school teaching programs and universities.

Quick-Finder School balances

Readability [d] g	Weighing capacity [Max] g	Model KERN	Price excl. of VAT ex works €	Page	DAYS	CAL EXT	RS 232	PCS	RECIPE	BATT	For an explanation on the pictos, see front flap											
0,001	100	EMB 100-3	240,-	16	1	●																●
0,001	200	EMB 200-3	260,-	16	1	●																●
0,001	200	EMB 200-3V	290,-	17	1	●			●													●
0,001	300	EMS 300-3	320,-	18	1	●				●												●
0,01	200	EMB 200-2	150,-	16	1	●																●
0,01	500	EHA 500-2	95,-	19	1	●																●
0,01	500	EFS 500-2	121,-	15	1	●																●
0,01	600	EMB 600-2	190,-	16	1	●																●
0,01	1000	EMB 1000-2	235,-	16	1	●																●
0,01	2000	EMB 2000-2	250,-	16	1	●																●
0,01	2000	EMB 2000-2V	290,-	17	1	●																●
0,01	3000	EMS 3000-2	300,-	18	1	●			●													●
0,1	220	EFS 200-1S05	205,-*	15	1	●																●
0,1	500	EMB 500-1	63,-	16	1	●																●
0,1	500	EMB 500-1BE	63,-	16	1	●																●
0,1	500	EHA 500-1	70,-	19	1	●																●
0,1	620	EFS 600-1S05	205,-*	15	1	●																●
0,1	1000	EHA 1000-1	75,-	19	1	●																●
0,1	1200	EMB 1200-1	85,-	16	1	●																●
0,1	3000	EMB 3000-1	150,-	16	1	●																●
0,1	3000	EFS 3000-1	104,-	15	1	●																●
0,1	3000	EHA 3000-1	95,-	19	1	●																●
0,1	6000	EMB 6000-1	190,-	16	1	●																●
0,1	6000	EMS 6K0.1	200,-	18	1	●																●
0,1	12000	EMS 12K0.1	250,-	18	1	●																●
1	2200	EFS 2000-0S05	207,-*	15	1	●																●
1	2200	EMB 2200-0	60,-	16	1	●																●
1	3000	EHA 3000-0	70,-	19	1	●																●
1	5200	EFS 5000-0S05	207,-*	15	1	●																●
1	5200	EMB 5.2K1	63,-	16	1	●																●
1	6000	EMS 6K1	100,-	18	1	●																●
1	12000	EMS 12K1	110,-	18	1	●																●
5	5200	EMB 5.2K5	60,-	16	1	●																●

News 2023

* Price set of 5 units

● = standard

○ = option



NEW **SCHOOL** ★
5x



02

Perfect school balances for experimental teaching
 - easy to use, space-saving, stackable

Features

- Simple and convenient 2-key operation, making them ideal for use in schools and universities
- Tare function facilitates formulation work
- Particularly flat design
- Secure and non-slip positioning with rubber feet
- **1** Stackable for space-saving storage
- **2** Practical battery operation using standard batteries ensures a high level of flexibility and freedom from mains adapters, sockets, chargers, etc.

Technical data

- Large LCD display, digit height 15 mm
- Dimensions weighing surface, plastic, WxD 134x127 mm
- Overall dimensions WxDxH 145x205x46,5 mm
- Battery operation, 4x1.5 V AA standard, operating time up to 200 h, Integrated AUTO-OFF function to preserve the batteries
- Net weight approx. 0,45 kg
- Permissible ambient temperature 10 °C / 40 °C
- **Note:** The models with the suffix -S05 are delivered in a set of 5 units. i.e. the price given in the table refers to 5 items. Cannot be delivered individually. The calibration prices refers to one single balance

Accessories

- External universal mains adapter, with universal input and optional input socket adapters for EU, CH, GB, USA, KERN YKA-27, € 43,-

STANDARD OPTION

CAL EXT
 BATT
 DMS
 1 DAY
 MULTI
 DAKKS
 +3 DAYS

Model	Weighing capacity [Max] g	Readability [d] g	Reproducibility g	Linearity g	Quantity delivered (balance)	Price excl. of VAT ex works €	Option DAKKS Calibr. Certificate DAKKS KERN	€
EFS 500-2	500	0,01	0,01	± 0,03	1	121,-	963-127	93,-
EFS 200-1S05	220	0,1	0,1	± 0,3	5	205,-*	963-127	93,-
EFS 600-1S05	620	0,1	0,1	± 0,3	5	205,-*	963-127	93,-
EFS 3000-1	3000	0,1	0,1	± 0,3	1	104,-	963-127	93,-
EFS 2000-0S05	2200	1	1	± 3	5	207,-*	963-127	93,-
EFS 5000-0S05	5200	1	1	± 3	5	207,-*	963-127	93,-

* Price set of 5 units



02



Entry level laboratory balance with tremendous weighing performance

Features

- Simple and convenient 2-key operation
- Tare function facilitates formulation work
- Particularly flat design
- Ready for use: Batteries included
- **1** Ring-shaped draught shield standard, only for models with weighing plate size \varnothing 82 mm, weighing space $\varnothing \times H$ 96 \times 35 mm
- Hook for underfloor weighing standard
- **2** Also available as KERN EMB 500-1BE Black Edition
- Note: With the optional auxiliary set for density determination KERN YDB-04 also well suited for school and teaching operation

Technical data

- Large LCD display, digit height 15 mm
- Dimensions weighing surface
 - A** \varnothing 82 mm, plastic, with conductive lacquer
 - B** \varnothing 105 mm, plastic
 - C** \varnothing 150 mm, plastic, see large picture
- Batteries included, 9 V block, respectively 2 \times 1.5 V AA
- Net weight approx. 0,85 kg
- Permissible ambient temperature 5 °C/35 °C

Accessories

- Stainless steel weighing plate, only for models with weighing plate size **B**, KERN EMB-A02, **€ 29,-**
- External universal mains adapter, with universal input and optional input socket adapters for EU, CH, GB, USA, KERN YKA-03N, **€ 38,-**
- **3** Ancillary kit for density determination of liquids and solids with density > 1. Scope of supplies: Bridge for holding the beaker (\varnothing 102 mm), hook (H 139 mm), suitable for models with weighing plate size **A**, KERN YDB-04, **€ 27,-**

STANDARD

CAL EXT UNIT UNDER BATT DMS 1 DAY

OPTION

B MULTI DAKKS +3 DAYS

Model	Weighing capacity [Max]	Readability [d]	Reproducibility	Linearity	Housing dimensions WxDxH mm	Weighing plate	Price excl. of VAT ex works €	Option	
								DAKKS KERN	Calibr. Certificate €
KERN EMB 100-3	100	0,001	0,001	\pm 0,005	170 \times 244 \times 54	A	240,-	963-127	93,-
EMB 200-3	200	0,001	0,001	\pm 0,005	170 \times 244 \times 54	A	260,-	963-127	93,-
EMB 200-2	200	0,01	0,01	\pm 0,02	170 \times 244 \times 39	B	150,-	963-127	93,-
EMB 600-2	600	0,01	0,01	\pm 0,03	170 \times 244 \times 39	B	190,-	963-127	93,-
EMB 1000-2	1000	0,01	0,01	\pm 0,05	170 \times 244 \times 39	C	235,-	963-127	93,-
EMB 2000-2	2000	0,01	0,01	\pm 0,05	170 \times 244 \times 39	C	250,-	963-127	93,-
EMB 500-1	500	0,1	0,1	\pm 0,2	170 \times 244 \times 39	C	63,-	963-127	93,-
EMB 500-1BE	500	0,1	0,1	\pm 0,2	170 \times 244 \times 39	C	63,-	963-127	93,-
EMB 1200-1	1200	0,1	0,1	\pm 0,3	170 \times 244 \times 39	C	85,-	963-127	93,-
EMB 3000-1	3000	0,1	0,1	\pm 0,3	170 \times 244 \times 39	C	150,-	963-127	93,-
EMB 6000-1	6000	0,1	0,1	\pm 0,3	170 \times 244 \times 39	C	190,-	963-128	112,-
EMB 2200-0	2200	1	1	\pm 2	170 \times 244 \times 39	C	60,-	963-127	93,-
EMB 5.2K1	5200	1	1	\pm 3	170 \times 244 \times 39	C	63,-	963-128	112,-
EMB 5.2K5	5200	5	5	\pm 10	170 \times 244 \times 39	C	60,-	963-128	112,-



School balance with integrated density determination function

Features

- Easy density determination: Thanks to the self-explanatory, graphic-assisted control panel, the density of solids and liquids can be determined in seconds, making them ideal for use in schools and universities
- Self-explanatory, graphic control panel, the workings steps can be understood immediately, even without operating instructions
 - no learning time = reduces costs
 - ideal for untrained users
 - visualised process avoids operating errors
- The 4 steps are carried out from left to right:
 - 1 Tare the balance by pressing the [TARE] key
 - 2 Select density determination mode (solids/liquids)
 - 3 Weighing of samples/plummetts in air
 - 4 Weighing of samples/plummetts in liquid. The density will be shown on the display right away
- Particularly flat design

- Hook for underfloor weighing standard
- Batteries included, 9 V block, operating time up to 12 h, AUTO-OFF function preserves the battery
- Note: Balance and appropriate set for density determination should be ordered at the same time, see accessories

Technical data

- Large LCD display, digit height 15 mm
- Dimensions weighing surface
 - A \varnothing 82 mm, plastic
 - B \varnothing 150 mm, plastic
- Overall dimensions WxDxH 175x245x54 mm
- Net weight approx. 0,85 kg
- Permissible ambient temperature 5 °C / 35 °C
- Also with carat weighing unit:
 - EMB 200-3V: 1000 ct/0,005 ct
 - EMB 2000-2V: 10000 ct/0,05 ct

Accessories

KERN EMB 200-3V:

- 5 Ancillary kit for density determination of liquids and solids with density > 1. Scope of delivery: Bridge for holding the beaker (\varnothing 102 mm), hook (H 139 mm), suitable for models with weighing plate size A, KERN YDB-04, € 27,-
- 6 Set for density determination of liquids and solids with density \leq/\geq 1. Scope of delivery: Weighing plate, beaker (Hx \varnothing 71x51 mm), sample holder, plummet, KERN YDB-01, € 270,-
- DAkkS-Calibration certificate for the plummet (20 g), KERN 962-335V, € 170,-

KERN EMB 2000-2V:

- 7 Set for density determination of liquids and solids with density \leq/\geq 1. Scope of delivery: Weighing plate, beaker (Hx \varnothing 135x100 mm), sample holder, plummet KERN YDB-02, € 470,-
- DAkkS-Calibration certificate for the plummet (200 g), KERN 962-338V, € 167,-
- Thermometer, KERN YDB-A03, € 38,-

STANDARD



OPTION



Model	Weighing capacity [Max] g	Readability [d] g	Reproducibility g	Linearity g	Weighing plate	Price excl. of VAT ex works €	Option DAkkS Calibr. Certificate	
							DAkkS KERN	€
EMB 200-3V	200	0,001	0,002	\pm 0,005	A	290,-	963-127	93,-
EMB 2000-2V	2000	0,01	0,02	\pm 0,05	B	290,-	963-127	93,-



02



Entry level model in the low-cost range with large weighing plate

Features

- Especially suitable for use in schools and universities, for example for biology, chemistry, physics
- Large, shock proof weighing plate made of plastic
- Particularly flat design
- Ergonomically optimised key pad with large keys and a high-contrast LCD display
- Secure and non-slip positioning with rubber feet
- Adjusting program CAL for quick setting of the balance accuracy, external test weights at an additional price, see *Test weights*
- **1** Draught shield standard for models with weighing plate size **A**, weighing space W×D×H 145×145×65 mm
- Suitable for common school LIMS systems

Technical data

- Large LCD display, digit height 25 mm
- Dimensions weighing surface
 - A** Ø 105 mm, plastic, with conductive lacquer
 - B** W×D 175×190 mm, plastic
- Overall dimensions W×D×H 200×280×63 mm
- Optional battery operation, 9 V block not included in scope of delivery, operating time up to 40 h
- Mains adapter external, standard
- Net weight approx. 1,4 kg
- Permissible ambient temperature 5 °C/35 °C

Accessories

- **2** Stainless steel weighing plate, only for models with weighing plate size **B**, KERN EMS-A01, € 33,-

STANDARD

CAL EXT PCS RECIPE PERCENT UNIT BATT MULTI DMS 1 DAY

OPTION

DAkkS +3 DAYS

Model	Weighing capacity [Max] g	Readability [d] g	Reproducibility g	Linearity g	Weighing plate	Price excl. of VAT ex works €	Option DAKkS Calibr. KERN	Certificate €
KERN EMS 300-3	300	0,001	0,002	± 0,005	A	320,-	963-127	93,-
KERN EMS 3000-2	3000	0,01	0,02	± 0,05	B	300,-	963-127	93,-
KERN EMS 6K0.1	6000	0,1	0,1	± 0,3	B	200,-	963-128	112,-
KERN EMS 12K0.1	12000	0,1	0,1	± 0,3	B	250,-	963-128	112,-
KERN EMS 6K1	6000	1	1	± 3	B	100,-	963-128	112,-
KERN EMS 12K1	12000	1	1	± 3	B	110,-	963-128	112,-



The compact all-round model with robust stainless steel weighing plate for use in laboratories, industries, and for teaching

Features

- Thanks to its compact, robust design, its bright display and high precision, this range is ideal for use in laboratories, quality control, production as well in schools and universities for teaching e.g. biology, chemistry and physics
- Large, shock proof weighing plate made from stainless steel, can be removed and therefore is hygienic and easy to clean
- **1** Particularly flat design
- Ergonomically-optimised key pad with large keys and a high-contrast LCD screen
- **2** Secure and non-slip positioning with rubber feet
- Level indicator and levelling feet for precise levelling of the scale, fitted as standard, to give the most accurate weighing result
- Adjusting program CAL for quick setting of the balance accuracy using an external test weight at an additional price, see *test weights*

Technical data

- Large backlit LCD display, digit height 22 mm
- Dimensions weighing surface, weighing plate material
 - A** Ø 105 mm, stainless steel
 - B** WxD 120x120 mm, stainless steel
- Overall dimensions WxDxH 225x160x50 mm
- Optional battery operation, 2x1.5 V AA not included in scope of delivery, operating time up to 70 h
- Mains adapter external, standard
- Net weight approx. 0,50 kg
- Permissible ambient temperature 5 °C/40 °C

STANDARD

CAL EXT PCS UNIT BATT MULTI DMS 1 DAY

OPTION

DAKKS +3 DAYS

Model	Weighing capacity [Max] g	Readability [d] g	Reproducibility g	Linearity g	Weighing plate	Price excl. of VAT ex works €	Option DAKKS Calibr. Certificate DAKKS KERN	Certificate €
KERN								
EHA 500-2	500	0,01	0,03	± 0,03	A	95,-	963-127	93,-
EHA 500-1	500	0,1	0,3	± 0,3	A	70,-	963-127	93,-
EHA 1000-1	1000	0,1	0,3	± 0,3	B	75,-	963-127	93,-
EHA 3000-1	3000	0,1	0,3	± 0,3	B	95,-	963-127	93,-
EHA 3000-0	3000	1	3	± 2	B	70,-	963-127	93,-

03



PRECISION BALANCES

Here you'll find a complete summary of the KERN laboratory scales series and their positioning within the precision scales segment on the basis of application, price-performance ratio and functional volume

PREMIUM LABORATORY BALANCES

				★★★★
			FES/FEJ	★★
PBS/PBJ	PES/PEJ			★

STANDARD LABORATORY BALANCES

					★★★★
	PLS/PLJ	PNS/PNJ	EW-/EG-N	PWS	★★
572					★

BASIC LABORATORY BALANCES

				EWJ	★★★★
		PCB	440		★★
PCD	PFB				★

PRECISION BALANCES

KERN school balances

are entry-level devices in the field of laboratory balances, and they cover basic applications. They feature simple operation and the very best price/performance ratio. In addition, they usually can be stacked and can be battery-operated as an alternative to a main power source. This means that they have the flexibility to be used in different locations.

See *school balances*

KERN Basic laboratory balances

are used in laboratory applications mostly as single-user balances for sample preparation, etc. They are fitted with all useful laboratory functions which will support the user in a helpful way. With their strain gauge measuring principle, they are used anywhere where individual weighings are carried out, such as, for example, checkweighing. These devices are often connected to printers or local PCs using the standard, integrated RS-232 data interface.

KERN Basic standard laboratory balances

offer you all the tools you would need for effective and accurate work in your laboratory environment. All important laboratory functions such as a recipe weighing function or data interfaces are on board at all times. But above all, the high-quality measuring principles of these balances such as force compensation or tuning fork measuring principle, allow

them to be used in dosing procedures with very small weight changes and rapid display. In addition these balances are often fitted with automatic internal adjustment, which means the balance can be used in any location.

KERN premium laboratory balances

are right at the top of the precision balance segment. The numerous equipment features of the standard balances are complemented by high-quality materials with robust, sturdy construction, high-quality, high-performance weighing systems, optimised operating sequences, speed benefits.

Tip: Together with the innovative KERN EasyTouch app, a premium laboratory balance supports its users in their typical workflows and increases the range of functions of the balance. In this way these scales can be operated more efficiently and quickly than devices from other quality classes. In particular, these balances are used in demanding laboratory applications and anywhere where the environmental conditions are not ideal because of vibrations or other interference, but where, naturally, the balance is expected to provide accurate weighing results. Another field of application for these balances is the pharmaceutical industry, which is subject to particularly demanding requirements and authorities such as, for example, the FDA (Food and Drug Administration).

Tip

Transform your weighing system into a powerful weighing system! Using the KERN EasyTouch App even a simple scale can be made into a powerful weighing system, offering a wide range of functions. You simply have to install the KERN EasyTouch App on your PC or tablet (Windows® or Android®), connect the balance (either with cable or wireless), activate the App and straightaway you will be able to control your balance using your PC or tablet. All details from page 132



If you have further questions on the subject of “Which balance will be best for my application?”, then please ask your personal KERN segment specialists who will be happy to help you.

Quick-Finder Precision balances

Readability [d] g	Weighing capacity [Max] g	Model	Price excl. of VAT ex works €	Page											
KERN															
For an explanation on the pictos, see front flap															
0,001	60	440-21A	395,-	28	1										
0,001	120	PFB 120-3	400,-	25	1										
0,001	200	PCB 200-3	375,-	26	1										
0,001	200	PFB 200-3	410,-	25	1										
0,001	220	EW 220-3NM	840,-	33	1										
0,001	220	EG 220-3NM	1060,-	33	1										
0,001	240	572-30	640,-	30	1										
0,001	250	PCD 250-3	385,-	24	1										
0,001	300	PFB 300-3	450,-	25	1										
0,001	300	EWJ 300-3	600,-	29	1										
0,001	300	EWJ 300-3H	680,-	29	1										
0,001	300	572-31	650,-	30	1										
0,001	350	PCD 300-3	415,-	24	1										
0,001	360	PCB 300-3	390,-	26	1										
0,001	420	PLS 420-3F	950,-	31	1										
0,001	420	PLJ 420-3F	1090,-	31	1										
0,001	420	EW 420-3NM	970,-	33	1										
0,001	420	EG 420-3NM	1160,-	33	1										
0,001	420	572-32	680,-	30	1										
0,001	620	PNS 600-3	820,-	32	1										
0,001	620	PNJ 600-3M	950,-	32	1										
0,001	620	EW 620-3NM	1080,-	33	1										
0,001	620	EG 620-3NM	1300,-	33	1										
0,001	620	PES 620-3M	1400,-	36	1										
0,001	620	PBS 620-3M	1820,-	35	1										
0,001	620	PEJ 620-3M	1660,-	36	1										
0,001	620	PBJ 620-3M	2140,-	35	1										
0,001	720	PLS 720-3A	1340,-	31	1										
0,001	720	PLJ 720-3AM	1530,-	31	1										
0,001	720	PLJ 720-3A	1490,-	31	1										
0,001	1200	PLS 1200-3A	1370,-	31	1										
0,001	1200	PLJ 1200-3A	1530,-	31	1										
0,001	2100	PLJ 2000-3A	2100,-	31	1										
0,01	200	440-33N	315,-	28	1										
0,01	300	PCB 300-2	295,-	26	1										
0,01	400	440-35N	365,-	28	1										
0,01	600	PFB 600-2	330,-	25	1										
0,01	600	440-35A	395,-	28	1										
0,01	600	EWJ 600-2SM	500,-	29	1										
0,01	600	EWJ 600-2M	510,-	29	1										
0,01	820	EW 820-2NM	760,-	33	1										
0,01	820	PWS 800-2	1120,-	34	1										
0,01	1200	PFB 1200-2	345,-	25	1										
0,01	1200	PCB 1000-2	355,-	26	1										
0,01	1600	572-33	600,-	30	1										
0,01	2000	PFB 2000-2	370,-	25	1										
0,01	2200	EW 2200-2NM	930,-	33	1										
0,01	2200	EG 2200-2NM	1110,-	33	1										
0,01	2200	PES 2200-2M	990,-	36	1										
0,01	2200	PEJ 2200-2M	1250,-	36	1										
0,01	2400	572-35	640,-	30	1										
0,01	2500	PCD 2500-2	370,-	24	1										
0,01	3000	PFB 3000-2	395,-	25	1										
0,01	3000	EWJ 3000-2	560,-	29	1										
0,01	3000	572-37	650,-	30	1										
0,01	3200	PNS 3000-2	740,-	32	1										
0,01	3200	PNJ 3000-2M	890,-	32	1										
0,01	3500	PCD 3000-2	410,-	24	1										
0,01	3600	PCB 3000-2	380,-	26	1										
0,01	4200	PLS 4200-2F	900,-	31	1										
0,01	4200	EW 4200-2NM	1030,-	33	1										
0,01	4200	PLJ 4200-2F	1070,-	31	1										
0,01	4200	EG 4200-2NM	1220,-	33	1										
0,01	4200	PES 4200-2M	1180,-	36	1										
0,01	4200	PBS 4200-2M	1540,-	35	1										
0,01	4200	PEJ 4200-2M	1430,-	36	1										
0,01	4200	PBJ 4200-2M	1900,-	35	1										
0,01	4200	572-39	680,-	30	1										
0,01	6200	EW 6200-2NM	1120,-	33	1										
0,01	6200	PLS 6200-2A	1350,-	31	1										
0,01	6200	PLJ 6200-2A	1480,-	31	1										

Quick-Finder Precision balances

Readability [d] g	Weighing capacity [Max] g	Model	Price excl. of VAT ex works €	Page											
For an explanation on the pictos, see front flap															
0,01	6200	PLJ 6200-2AM	1530,-	31	1	○	●								
0,01	6200	PES 6200-2M	1450,-	36	1			●							○
0,01	6200	PBS 6200-2M	1850,-	35	1			●							
0,01	6200	PBJ 6200-2M	2300,-	35	1	○	●								
0,01	8200	PLS 8000-2A	1540,-	31	1			●							
0,05	6000	PFB 6000-2	350,-	25	1			●							
0,05	12000	572-45	650,-	30	1			●	○						○
0,05	20000	572-55	680,-	30	1			●	○						○
0,1	400	440-43N	235,-	28	1			●							○
0,1	1000	440-45N	265,-	28	1			●							○
0,1	2000	PCB 2000-1	275,-	26	1			●	○						○
0,1	2000	440-47N	315,-	28	1			●							○
0,1	3200	PWS 3000-1	1020,-	34	1			●							○
0,1	4000	440-49N	365,-	28	1			●							○
0,1	6000	PCD 6K-4	295,-	24	1			●							○
0,1	6000	PFB 6000-1	300,-	25	1			●							
0,1	6000	PCB 6000-1	300,-	26	1			●	○						○
0,1	6000	440-49A	395,-	28	1			●							○
0,1	6000	EWJ 6000-1SM	480,-	29	1	○	●								○
0,1	6000	EWJ 6000-1M	490,-	29	1	○	●								○
0,1	8200	PWS 8000-1	1150,-	34	1			●							○
0,1	8200	PBJ 8200-1M	1890,-	35	1	○	●								
0,1	10000	PCD 10K0.1	300,-	24	1			●							○
0,1	10000	PCB 10000-1	315,-	26	1			●	○						○
0,1	10000	572-43	630,-	30	1			●	○						○
0,1	12000	PNS 12000-1	720,-	32	1			●							
0,1	12000	PNJ 12000-1M	870,-	32	1	○	●								
0,1	12000	EW 12000-1NM	880,-	33	1			●							○
0,1	15000	PES 15000-1M	1380,-	36	1			●							○
0,1	16000	572-49	640,-	30	1			●	○						○
0,1	17000	FEJ 17K-4M	3080,-	37	1	○	●								
0,1	17000	FES 17K-4	2850,-	37	1			●							
0,1	20000	PLS 20000-1F	890,-	31	1			●							
0,1	24000	572-57	660,-	30	1			●	○						○
0,1	31000	PES 31000-1M	2430,-	36	1			●							○
0,1	33000	FES 33K-4	3000,-	37	1			●							
0,1	33000	FEJ 33K-4M	3340,-	37	1	○	●								
0,1 1	6200 62000	FES 62K-4D	3300,-	37	1			●							
0,1 1	6200 62000	FEJ 62K-4DM	3650,-	37	1	○	●								
1	4000	440-51N	175,-	28	1			●							○
1	6000	PCB 6000-0	210,-	26	1			●	○						○
1	6000	440-53N	240,-	28	1			●							○
1	10000	PCD 10K-3	215,-	24	1			●							○

News 2023

● = standard

○ = option

03



BASIC
★



High-resolution precision balance with removable display for maximum flexibility

Features

- Laboratory balance with separate platform: Ideal when working in a glove bag or fume cupboard. Particularly practical for weighing toxic, volatile or contaminated substances
- PRE-TARE function for manual subtraction of a known container weight, useful for checking fill-levels
- Freely programmable weighing unit, e.g. display direct in special units such as length of thread g/m, paper weight g/m², or similar
- Level indicator and levelling feet for precise levelling of the scale, fitted as standard, to give the most accurate weighing result
- **1** Draught shield standard for models with weighing plate size **A**, weighing space W×D×H 146×146×80 mm
- Protective working cover included with delivery

Technical data

- Large backlit LCD display, digit height 21 mm
- Dimensions weighing surface
 - A** Ø 105 mm, plastic, with conductive lacquer
 - B** W×D 160×160 mm, stainless steel, see larger picture
- Optional battery operation, 9 V block not included in scope of delivery, operating time up to 12 h, AUTO-OFF function to preserve the battery
- Overall dimensions (without draught shield) W×D×H 165×280×75 mm
- Overall dimensions (incl. draught shield) W×D×H 165×280×141 mm (PCD 250-3, PCD 300-3)
- Dimensions of display device W×D×H 140×46×82 mm
- Cable length of display device approx. approx. 1,2 m
- Net weight approx. 1,2 kg
- Permissible ambient temperature 5 °C/35 °C

Accessories

- Protective working cover over the display device, scope of delivery: 5 items, KERN PCD-A05S05, **€ 44,-**
- **2** Stand to elevate display device, height of stand approx. 250 mm, KERN PCD-A03, **€ 66,-**
- Internal rechargeable battery pack, operating time up to 24 h without backlight, charging time approx. 10 h, KERN PCD-A04, **€ 59,-**
- **3** Foot switch, ideal when the application requires two free hands. TARE or PRINT function can be selected. Scope of delivery: foot switch, junction box, connection cable. For the PRINT function you will need the RS-232 interface cable, KERN YKF-01, **€ 100,-**
- RS-232/Ethernet adapter for connection to an IP-based Ethernet network, KERN YKI-01, **€ 345,-**
- Individual header data: the free software can be used to print 4 header lines on the printout when using printers KERN 911-013, YKN-01, YKB-01N and YKE-01 (in combination with YKI-02)
- Further details, plenty of further accessories and suitable printers see *Accessories*

STANDARD



OPTION



Model	Weighing capacity [Max] g	Readability [d] g	Reproducibility g	Linearity g	Weighing plate	Price excl. of VAT ex works €	Option	
							DAkKS KERN	Certificate €
PCD 250-3	250	0,001	0,002	± 0,005	A	385,-	963-127	93,-
PCD 300-3	350	0,001	0,002	± 0,005	A	415,-	963-127	93,-
PCD 2500-2	2500	0,01	0,02	± 0,05	B	370,-	963-127	93,-
PCD 3000-2	3500	0,01	0,02	± 0,05	B	410,-	963-127	93,-
PCD 6K-4	6000	0,1	0,1	± 0,3	B	295,-	963-128	112,-
PCD 10K0.1	10000	0,1	0,1	± 0,3	B	300,-	963-128	112,-
PCD 10K-3	10000	1	1	± 3	B	215,-	963-128	112,-

BASIC
★



03

Quick-display precision balance with user-friendly concept of operation mode – now with larger housing for more stability

Features

- Easy to use: All primary functions have their own key on the keypad
- Compact size, practical for small spaces
- Capacity display: A bargraph display lights up to show how much of the weighing range is still available
- Level indicator and levelling feet for precise levelling of the scale, fitted as standard, to give the most accurate weighing result
- Draught shield standard for models with weighing plate size **A** ø 80 mm, **B** ø 120 mm, Weighing space W×D×H 116×111×65 mm

Technical data

- Backlit LCD display, digit height 15 mm
- Dimensions weighing surface, stainless steel
 - A** ø 80 mm
 - B** ø 120 mm
 - C** W×D 190×180 mm, see larger picture
- Overall dimensions (without draught shield) W×D×H 210×315×90 mm
- Permissible ambient temperature 15 °C/30 °C

Accessories

- Protective working cover, scope of delivery 5 items, KERN PFB-A12S05, € 44,-
- Bluetooth data interface for wireless data transfer to PC or tablets, must be ordered at purchase
 - Bluetooth 2.0: KERN PFB-A10, € 105,-
 - Bluetooth 4.0: KERN PFB-A11, € 155,-
- Further details, plenty of further accessories and suitable printers see *Accessories*

STANDARD



OPTION



FACTORY

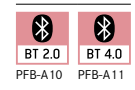

Model	Weighing capacity [Max] g	Readability [d] g	Reproducibility g	Linearity g	Weighing plate	Price excl. of VAT ex works €	Option DAKKS Calibr. Certificate DAKKS KERN	Certificate €
PFB 120-3	120	0,001	0,001	± 0,003	A	400,-	963-127	93,-
PFB 200-3	200	0,001	0,002	± 0,005	A	410,-	963-127	93,-
PFB 300-3	300	0,001	0,002	± 0,005	A	450,-	963-127	93,-
PFB 600-2	600	0,01	0,01	± 0,03	B	330,-	963-127	93,-
PFB 1200-2	1200	0,01	0,01	± 0,03	B	345,-	963-127	93,-
PFB 2000-2	2000	0,01	0,02	± 0,05	B	370,-	963-127	93,-
PFB 3000-2	3000	0,01	0,02	± 0,05	B	395,-	963-127	93,-
PFB 6000-2	6000	0,05	0,05	± 0,15	C	350,-	963-128	112,-
PFB 6000-1	6000	0,1	0,1	± 0,3	C	300,-	963-128	112,-



The standard in the laboratory, ideal for a wide range of applications for Industry 4.0

Features

- Compatible with school-specific software solutions such as, for example, Vernier® or LabQuest®. Thanks to the KERN School Protocol, as part of technical experiments, weighing data can be transferred to a PC, laptop, etc. for evaluation and display using the USB data interface
- Industry 4.0: The integrated KERN Universal Port (KUP) allows the connection of external KUP interface adapters such as RS-232, USB, Bluetooth, WLAN, Analogue, Ethernet etc. The outstanding advantage here is that the KUP interface adapters are simply plugged in, i.e. retrofitting interfaces is conveniently possible without opening the scale housing or complicated installation. The interface adapters enable convenient transmission of weighing data to networks,

- PCs, smartphones, tablets, laptops, printers etc. In addition, control commands and data inputs can also be sent to the scale via the connected devices. Tip: with the KERN KUP-13 extension box, up to three KUP interface adapters can be operated in parallel on the scale.
- KERN Communication Protocol (KCP): The KCP permits searching and remote control of the balance using external control devices or computers. for details see page 8/9
- Standardised, simplified concept of operation
- PRE-TARE function for manual subtraction of a known container weight, useful for checking fill-levels
- With the recipe function you can weigh the different ingredients of a mixture. As a check, you can also call up the total weight of all the ingredients

- Weighing with tolerance range (checkweighing): a visual signal helps with portioning, dispensing or grading
- Freely programmable weighing unit, e.g. display direct in special units such as length of thread g/m, paper weight g/m², or similar
- A special Anti-Shock system between the weighing plate and weighing cell reduces vibrations during the weighing process and in this way ensures rapid, reliable weighing results
- Ring-shaped draught shield standard, only for models with weighing plate size A, Ø 82 mm, weighing space Ø×H 90×40 mm
- Protective working cover included with delivery



Technical data

- Backlit LCD display, digit height 21 mm
- Dimensions weighing surface
 - A** Ø 82 mm
 - B** Ø 105 mm
 - C** W×D 130×130 mm
 - D** W×D 150×170 mm, see larger picture
- Weighing plate material
 - A** plastic, with conductive lacquer
 - B, C, D** stainless steel
- Overall dimensions (without draught shield) W×D×H 163×245×65 mm
- Optional battery operation, 4×1.5 V AA not included in scope of delivery, operating time up to 20 h, AUTO-OFF function to preserve the battery
- Permissible ambient temperature -10 °C/40 °C

Accessories

- Protective working cover, scope of delivery: 5 items, KERN YBA-A12S05, **€ 44,-**
- Internal rechargeable battery pack, operating time up to 48 h without backlight, charging time approx. 8 h, KERN YKR-01, **€ 35,-**
- External data interface RS-232, Interface cable included, KERN YKUP-01, **€ 68,-**
- External data interface USB, Interface cable included, KERN YKUP-03, **€ 98,-**
- External data interface Ethernet, KERN YKUP-04, **€ 125,-**
- WiFi interface adapter, KERN YKUP-05, **€ 98,-**
- Extension-Box, KERN YKUP-13, **€ 98,-**
- Software BalanceConnection, for flexible recording or transmission of measured values, in particular also to Microsoft® Excel or Access as well as transfer of this data to other Apps and programs, For more details see the internet, Scope of supplies: 1 CD, 1 license, KERN SCD-4.0, **€ 189,-**
- Individual header data: the free software SHM-01 can be used to print 4 header lines on the printout when using printers 911-013, YKN-01, YKB-01N, YKE-01 and YKC-01 (in combination with YKI-02)
- Further details, plenty of further accessories and suitable printers see *Accessories*

STANDARD



OPTION



Model	Weighing capacity [Max]	Readability	Reproducibility	Linearity	Weighing plate	Price excl. of VAT ex works €	Option DAKKS Calibr. Certificate DAKKS KERN	Dertificate €
KERN PCB 200-3	200 g	0,001 g	0,001 g	± 0,005 g	A	375,-	963-127	93,-
KERN PCB 300-3	360 g	0,001 g	0,001 g	± 0,005 g	A	390,-	963-127	93,-
KERN PCB 300-2	300 g	0,01 g	0,01 g	± 0,02 g	B	295,-	963-127	93,-
KERN PCB 1000-2	1000 g	0,01 g	0,01 g	± 0,03 g	C	355,-	963-127	93,-
KERN PCB 3000-2	3600 g	0,01 g	0,01 g	± 0,05 g	C	380,-	963-127	93,-
KERN PCB 2000-1	2000 g	0,1 g	0,1 g	± 0,2 g	C	275,-	963-127	93,-
KERN PCB 6000-1	6000 g	0,1 g	0,1 g	± 0,3 g	D	300,-	963-128	112,-
KERN PCB 10000-1	10000 g	0,1 g	0,1 g	± 0,3 g	D	315,-	963-128	112,-
KERN PCB 6000-0	6000 g	1 g	1 g	± 2 g	D	210,-	963-128	112,-



03



The classic balance in the laboratory

Features

- Compact size, practical for small spaces
- Percentage determination: makes it possible to store a given weight value (100 %) and to determine deviations from this target value
- Ring-shaped draught shield standard, only for models with weighing plate size **A** \varnothing 81 mm, weighing space $\varnothing \times H$ 90 \times 40 mm
- Protective working cover included with delivery

Technical data

- Backlit LCD display, digit height 15 mm
- Dimensions weighing surface, weighing plate material
 - A** \varnothing 81 mm, plastic, with conductive lacquer
 - B** \varnothing 105 mm, stainless steel
 - C** W \times D 130 \times 130 mm, stainless steel
 - D** W \times D 150 \times 170 mm, stainless steel, see larger picture
- Overall dimensions W \times D \times H 165 \times 230 \times 80 mm (without draught shield)
- Optional battery operation, 9 V block not included in scope of delivery, operating time up to 20 h, AUTO-OFF function to preserve the battery
- Net weight approx. 0,95 kg
- Permissible ambient temperature 5 °C/35 °C

Accessories

- Protective working cover, scope of delivery: 5 items, for models with weighing plate size
 - A** KERN 440-210-002S05, € 44,-
 - B** KERN 440-330-002S05, € 44,-
 - C** KERN 440-450-002S05, € 44,-
 - D** KERN 440-530-002S05, € 44,-
- Internal rechargeable battery pack, operating time up to 20 h without backlight, charging time approx. 10 h, KERN FCB-A01, € 54,-
- Hook for underfloor weighing, KERN 440-A01, € 27,-
- RS-232/Ethernet adapter for connection to an IP-based Ethernet network, KERN YKI-01, € 345,-
- Individual header data: the free software SHM-01 can be used to print 4 header lines on the printout when using printers 911-013, YKN-01, YKB-01N, YKE-01 and YKC-01 (in combination with YKI-02)
- Further details, plenty of further accessories and suitable printers see *Accessories*

STANDARD



OPTION



Model	Weighing capacity [Max] g	Readability [d] g	Reproducibility g	Linearity g	Weighing plate	Price		
						Price excl. of VAT ex works €	Option DAkKS Calibr. DAkKS KERN	Certificate €
440-21A	60	0,001	0,001	\pm 0,003	A	395,-	963-127	93,-
440-33N	200	0,01	0,01	\pm 0,02	B	315,-	963-127	93,-
440-35N	400	0,01	0,01	\pm 0,03	B	365,-	963-127	93,-
440-35A	600	0,01	0,01	\pm 0,03	B	395,-	963-127	93,-
440-43N	400	0,1	0,1	\pm 0,2	C	235,-	963-127	93,-
440-45N	1000	0,1	0,1	\pm 0,2	C	265,-	963-127	93,-
440-47N	2000	0,1	0,1	\pm 0,2	C	315,-	963-127	93,-
440-49N	4000	0,1	0,1	\pm 0,3	D	365,-	963-127	93,-
440-49A	6000	0,1	0,1	\pm 0,3	D	395,-	963-128	112,-
440-51N	4000	1	1	\pm 2	D	175,-	963-127	93,-
440-53N	6000	1	1	\pm 2	D	240,-	963-128	112,-



High-quality precision balance with automatic internal adjustment, also with EC type approval [M]

Features

- Easy to use: All primary functions have their own key on the keypad
- Automatic internal adjustment, time-controlled every 2 h, guarantees high degree of accuracy and makes the balance independent of its location
- Capacity display: A bargraph display lights up to show how much of the weighing range is still available
- KERN EWJ-H/-M: USB data interface for transferring weighing data to the PC, printer etc.
- KERN EWJ-SM: Cost-effective variant without data interfaces
- KERN EWJ 300-3, 600-2M, 600-2SM: Draught shield standard, Weighing space W×D×H 134×128×80 mm
- **1** KERN EWJ 300-3H: Large glass draught shield with 3 sliding doors for easy access to the items being weighed. Weighing space W×D×H 155×175×217 mm
- Protective working cover included with delivery

Technical data

- Large LCD display, digit height 16,5 mm
- Dimensions weighing surface
 - A** Ø 80 mm, stainless steel
 - B** Ø 120 mm, stainless steel
 - C** Ø 135 mm, stainless steel, see larger picture
 - D** W×D 155×145 mm, stainless steel
- Overall dimensions (without draught shield) W×D×H
 - A, B** 220×315×90 mm
 - C** 220×315×105 mm
 - D** 215×330×105 mm
- Overall dimensions (incl. draught shield) W×D×H
 - EWJ 300-3, 600-2M, 600-2SM: 220×340×180 mm
 - EWJ 300-3H: 220×340×321 mm
- Permissible ambient temperature
 - KERN EWJ: 15 °C/35 °C
 - KERN EWJ-M: 15 °C/30 °C

Accessories

- Protective working cover, scope of delivery 5 items, KERN EWJ-A04S05, **€ 44,-**
- Internal rechargeable battery pack, operating time up to 20 h without backlight, charging time approx. 12 h, KERN KFB-A01, **€ 40,-**
- KERN EWJ-H/-M: Software BalanceConnection, for flexible recording or transmission of measured values, in particular also to Microsoft® Excel or Access as well as transfer of this data to other Apps and programs, for more details see the internet, Scope of supplies: 1 CD, 1 license, KERN SCD-4.0, **€ 189,-**
- RS-232/WiFi adapter for wireless connection to networks and WiFi capable devices, such as tablets, laptops or smartphones, KERN YKI-03, **€ 820,-**
- RS-232/Ethernet adapter for connection to an IP-based Ethernet network, KERN YKI-01, **€ 345,-**
- Further details, plenty of further accessories and suitable printers see *Accessories*

STANDARD

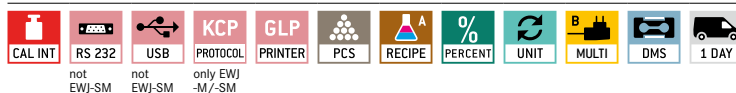

OPTION



FACTORY



Model	Weighing capacity [Max] g	Readability [d] g	Verification value [e] g	Minimal load [Min] g	Linearity g	Weighing plate	Price excl. of VAT ex works €	Verification KERN €	Option DAkkS Calibr. Certificate DAkkS KERN €
KERN EWJ 300-3	300	0,001	-	-	± 0,005	A	600,-	-	- 963-127 93,-
KERN EWJ 300-3H	300	0,001	-	-	± 0,005	A	680,-	-	- 963-127 93,-
KERN EWJ 3000-2	3000	0,01	-	-	± 0,05	C	560,-	-	- 963-127 93,-
Note: For applications that require verification, please order verification at the same time, initial verification at a later date is not possible. Verification at the factory, we need to know the full address of the location of use.									
KERN EWJ 600-2SM	600	0,01	0,1	0,5	± 0,03	B	500,-	965-216 80,-	963-127 93,-
KERN EWJ 600-2M	600	0,01	0,1	0,5	± 0,03	B	510,-	965-216 80,-	963-127 93,-
KERN EWJ 6000-1SM	6000	0,1	1	5	± 0,3	D	480,-	965-217 93,-	963-128 112,-
KERN EWJ 6000-1M	6000	0,1	1	5	± 0,3	D	490,-	965-217 93,-	963-128 112,-

03



All-rounder e.g. as precision balance in the laboratory or in harsh industrial applications, ideal for the diverse possibilities of Industry 4.0 applications

Features

- Thanks to the many typical laboratory functions, such as, for example, recipe function, percentage determination, combined with the high level of precision, the KERN 572 is a reliable partner for day-to-day work in the laboratory
- The robust version, typical industrial functions, such as piece-counting, vibrationfree weighing and the large weighing ranges also make these balances ideal for all industrial applications, where a high level of precision is required
- KERN Universal Port (KUP): permits the connection of an external KUP interface adapter, such as, for example, RS-232, USB, Bluetooth or Ethernet, for the exchange of data and control commands, without any installation outlay

- KERN Communication Protocol (KCP): The KCP permits searching and remote control of the balance using external control devices or computers, for details see page 8/9
- Standardised, simplified concept of operation
- Freely programmable weighing unit, e.g. display direct in special units such as length of thread g/m, paper weight g/m², or similar
- The robust aluminium diecast housing maintains the stability, protects the weighing technology elements and is robust enough to cope with everyday use
- Ring-shaped draught shield standard, only for models with weighing plate size A ø 106 mm, weighing space ø×H 157×43 mm
- Level indicator to level the balance precisely
- Loop for underfloor weighing, standard for models with [d] = 0,001 g
- Protective working cover included with delivery

Technical data

- Large backlit LCD display, digit height 21 mm
- Dimensions weighing surface, stainless steel
 - A ø 106 mm
 - B ø 150 mm
 - C W×D 160×200 mm, see larger picture
- Overall dimensions (without draught shield) W×D×H 180×310×85 mm
- Net weight A, B approx. 2,4 kg
 - C approx. 2,8 kg
- Permissible ambient temperature -10 °C/40 °C

Accessories

- Protective working cover, scope of delivery: 5 items, KERN 572-A02S05, € 44,-
- Internal rechargeable battery pack, operating time up to 48 h without backlight, charging time approx. 8 h, KERN YKR-01, € 35,-
- External data interface RS-232, interface cable included, KERN YKUP-01, € 68,-
- External data interface USB, interface cable included, KERN YKUP-03, € 98,-
- Extension-Box, KERN YKUP-13, € 98,-
- Loop and hook for underfloor weighing, for models with [d] ≥ 0,01 g, KERN 572-A03, € 25,-
- Large glass draught shield with 3 sliding doors for easy access to the items being weighed. Weighing space W×D×H 150×140×130 mm, for models with weighing plate size A, KERN 572-A05, € 250,-



Model	Weighing capacity [Max] g	Readability [d] g	Reproducibility g	Linearity g	Resolution Points	Weighing plate	Price excl. of VAT ex works €	Option DAKKS Calibr. Certificate DAKKS KERN €
572-30	240	0,001	0,001	± 0,003	240.000	A	640,-	963-127 93,-
572-31	300	0,001	0,002	± 0,005	300.000	A	650,-	963-127 93,-
572-32	420	0,001	0,002	± 0,005	420.000	A	680,-	963-127 93,-
572-33	1600	0,01	0,01	± 0,03	160.000	B	600,-	963-127 93,-
572-35	2400	0,01	0,01	± 0,03	240.000	B	640,-	963-127 93,-
572-37	3000	0,01	0,02	± 0,05	300.000	B	650,-	963-127 93,-
572-39	4200	0,01	0,02	± 0,05	420.000	B	680,-	963-127 93,-
572-45	12000	0,05	0,05	± 0,15	240.000	C	650,-	963-128 112,-
572-55	20000	0,05	0,1	± 0,25	400.000	C	680,-	963-128 112,-
572-43	10000	0,1	0,1	± 0,3	100.000	C	630,-	963-128 112,-
572-49	16000	0,1	0,1	± 0,3	160.000	C	640,-	963-128 112,-
572-57	24000	0,1	0,1	± 0,3	240.000	C	660,-	963-128 112,-



03

Range of precision balances with enormous weighing capacities – ideal for heavy tare containers or large samples

Features

- 1 Convenient recipe-weighing: with the recipe database, in which up to 99 recipes can be stored, each with up to 20 recipe ingredients with name and target value
- Internal memory for complete recipes with name and target value of the recipe ingredients. User guidance through display
- Rapid and efficient operation thanks to the graphics display. Simple, clear user interface on the display in the following languages: DE, EN, FR, IT, ES, PT
- Dosage aid: High stability mode and other filter settings can be selected

- KERN PLJ: Automatic internal adjustment, guarantees high degree of accuracy and makes the balance independent of its location of use. Ideal for mobile applications which require verification, such as ambulatory gold and jewellery purchasing
- 2 PLJ 2000-3A: High-quality milligram balance with enormous weighing range up to 2100 g – ideal for large samples or heavy tare containers. Large glass draught shield for easy access to the items being weighed. Weighing space W×D×H 160×170×225 mm, standard
- Ring-shaped draught shield standard, only for models with weighing plate size \varnothing 110 mm, weighing space \varnothing ×H 150×60 mm

- Protective working cover included with delivery

Technical data

- Backlit LCD Graphic display, digit height 15 mm
- Dimensions weighing surface
 - A \varnothing 110 mm, stainless steel
 - B \varnothing 160 mm, stainless steel, see larger picture
 - C W×D 200×175 mm, stainless steel
- Permissible ambient temperature 15 °C/35 °C

Accessories

- Protective working cover, scope of delivery 5 items, KERN PLJ-A01S05, € 44,-
- 3 Hook f. underfloor weighing, KERN PLJ-A02, € 32,-
- Set for density determination of liquids and solids for models with [d] = 0,001 g, KERN ALT-A02, € 900,-
- Minimum weight of sample, smallest weight to be weighed, depending on the required process accuracy, only in combination with a DAkkS calibration certificate, KERN 969-103, € 10,-
- Equipment qualification: compliant qualification concept which includes the following validation services, Installation Qualification (IQ), Operating Qualification (OQ), for details see page 216

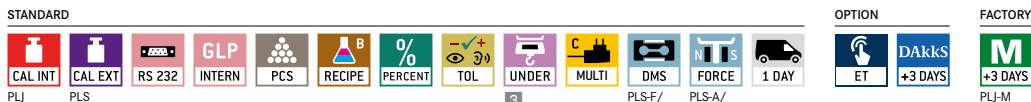

Model	Weighing capacity [Max] g	Readability [d] g	Verification value [e] g	Minimal load [Min] g	Linearity g	Weighing plate	Price excl. of VAT ex works €	Option			
								Verification	DAkkS	Calibr. Certificate	
KERN								M	DAkkS	KERN	€
PLS 420-3F	420	0,001	-	-	± 0,004	A	950,-	-	-	963-127	93,-
PLS 720-3A	720	0,001	-	-	± 0,002	A	1340,-	-	-	963-103	154,-
PLS 1200-3A	1200	0,001	-	-	± 0,003	A	1370,-	-	-	963-103	154,-
PLS 4200-2F	4200	0,01	-	-	± 0,04	B	900,-	-	-	963-127	93,-
PLS 6200-2A	6200	0,01	-	-	± 0,03	B	1350,-	-	-	963-104	175,-
PLS 8000-2A	8200	0,01	-	-	± 0,04	B	1540,-	-	-	963-104	175,-
PLS 20000-1F	20000	0,1	-	-	± 0,4	C	890,-	-	-	963-128	112,-
PLJ											
PLJ 420-3F	420	0,001	-	-	± 0,003	A	1090,-	-	-	963-127	93,-
PLJ 720-3A	720	0,001	-	-	± 0,002	A	1490,-	-	-	963-103	154,-
PLJ 1200-3A	1200	0,001	-	-	± 0,003	A	1530,-	-	-	963-103	154,-
PLJ 2000-3A	2100	0,001	-	-	± 0,004	A	2100,-	-	-	963-103	154,-
PLJ 4200-2F	4200	0,01	-	-	± 0,04	B	1070,-	-	-	963-127	93,-
PLJ 6200-2A	6200	0,01	-	-	± 0,03	B	1480,-	-	-	963-104	175,-

Note: For applications that require verification, please order verification at the same time, initial verification at a later date is not possible.

Verification at the factory, we need to know the full address of the location of use.

PLJ 720-3AM	720	0,001	0,01	0,02	± 0,002	A	1530,-	965-216	80,-	963-103	154,-
PLJ 6200-2AM	6200	0,01	0,1	0,5	± 0,03	B	1530,-	965-217	93,-	963-104	175,-

STANDARD



EasyTouch



03

The new standard in the laboratory with robust tuning fork weighing system, also with EC type approval [M]

Features

- KERN PNS: Adjusting program CAL for quick setting of the balance accuracy using an external test weight at an additional price, see *test weights*
- KERN PNJ: Automatic internal adjustment, guarantees high degree of accuracy and makes the balance independent of its location of use Ideal for mobile applications which require verification, such as ambulatory gold and jewellery purchasing
- High-quality tuning fork measuring system for steady weight values and continuous weighing
- Capacity display: A bargraph display lights up to show how much of the weighing range is still available
- Precise counting: The automatic reference weight optimisation of reference weight gradually improves the average piece weight value
- Compact size, practical for small spaces
- Large, shock proof weighing plate made of stainless steel

- **A** Large glass draught shield with 3 sliding doors for easy access to the items being weighed, for models with weighing plate size \varnothing 140 mm, Weighing space W×D×H 172×171×160 mm
- Protective working cover included with delivery

Technical data

- Large LCD display, digit height 16,5 mm
- Dimensions weighing surface, stainless steel
 - A** \varnothing 140 mm
 - B** W×D 190×190 mm, see larger picture
- Overall dimensions W×D×H, without draught shield
 - A** 196×293×266 mm, **B** 196×293×89 mm
- Net weight
 - A** approx. 4,2 kg, **B** approx. 3,6 kg
- Permissible ambient temperature 5 °C/40 °C

Accessories

- Protective working cover, scope of delivery 5 items, KERN PNJ-A01S05, **€ 44,-**
- RS-232/Bluetooth adapter to connect to Bluetooth capable devices, such as Bluetooth printers, tablets, laptops, smartphones, etc., KERN YKI-02, **€ 345,-**
- RS-232/WiFi adapter for wireless connection to networks and WiFi capable devices, such as tablets, laptops or smartphones, KERN YKI-03, **€ 820,-**
- RS-232/Ethernet adapter for connection to an IP-based Ethernet network, KERN YKI-01, **€ 345,-**
- **1** Gemstones plate, aluminium with practical spout, W×D×H 130×80×30 mm, KERN AEJ-A05, **€ 43,-**
- Minimum weight of sample, smallest weight to be weighed, depending on the required process accuracy, only in combination with a DAkkS calibration certificate, KERN 969-103, **€ 10,-**
- Equipment qualification: compliant qualification concept which includes the following validation services, Installation Qualification (IQ), Operating Qualification (OQ), for details see page 216
- Further details, plenty of further accessories and suitable printers see *Accessories*

STANDARD

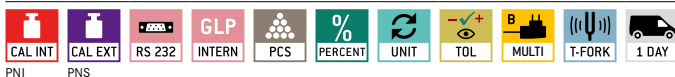

OPTION



FACTORY



Model	Weighing capacity [Max] g	Readability [d] g	Verification value [e] g	Minimal load [Min] g	Linearity g	Weighing plate	Price excl. of VAT ex works €	Option			
								Verification KERN	DAkkS Calibr. €	Certificate DAKKS KERN	€
KERN PNS 600-3	620	0,001	-	-	± 0,004	A	820,-	-	-	963-103	154,-
KERN PNS 3000-2	3200	0,01	-	-	± 0,02	B	740,-	-	-	963-127	93,-
KERN PNS 12000-1	12000	0,1	-	-	± 0,2	B	720,-	-	-	963-128	112,-

Note: For applications that require verification, please order verification at the same time, initial verification at a later date is not possible.

Verification at the factory, we need to know the full address of the location of use.

PNJ 600-3M	620	0,001	0,01	0,02	± 0,004	A	950,-	965-216	80,-	963-103	154,-
PNJ 3000-2M	3200	0,01	0,1	0,5	± 0,02	B	890,-	965-216	80,-	963-127	93,-
PNJ 12000-1M	12000	0,1	1	5	± 0,2	B	870,-	965-217	93,-	963-128	112,-



STANDARD



EasyTouch



03

- Net weight **A**, **B** approx. 2,0 kg, **C** approx. 4,0 kg
- Permissible ambient temperature 10°C/30°C

The classic balance with robust tuning fork measuring system

Features

- **1** KERN EG-N: Internal adjustment in the case of a change in temperature and time-controlled at defined intervals, guarantees high degree of accuracy and makes the balance independent of its location of use
- KERN EW-N: Adjusting program CAL for quick setting of the balance accuracy using an external test weight at an additional price, see *test weights*
- Stable temperature behaviour
- Short stabilisation time
- Shock proof construction
- High corner load performance
- Capacity display: A bargraph display lights up to show how much of the weighing range is still available

- GLP/ISO record keeping of weight values
- Totalising of pieces when counting
- Draught shield standard for models with weighing plate size **A**, weighing space W×D×H 158×130×78 mm
- Protective working cover included with delivery

Technical data

- Large LCD display, digit height 17 mm
- Dimensions weighing surface
 - A** Ø 118 mm, stainless steel, see larger picture
 - B** W×D 170×140 mm, stainless steel
 - C** W×D 180×160 mm, stainless steel
- Overall dimensions W×D×H (without draught shield) **A**, **B** 182×235×65 mm, **C** 265×192×87 mm

Accessories

- Protective working cover, scope of delivery: 5 items, for models with weighing plate size **A**, **B** KERN EG-A05S05, € 44,-
C KERN EG-A09S05, € 44,-
- Internal rechargeable battery pack, operating time up to 32 h without backlight, charging time approx. 12 h, for models with weighing plate size **A**, **B** KERN EG-A04, € 130,-
C KERN EG-A06, € 130,-
- Large glass draught shield with 3 sliding doors for easy access to the items being weighed. Weighing space W×D×H 150×140×130 mm, KERN EG-A03, € 270,-
- Loop for underfloor weighing, for models with weighing plate size **A**, **B** KERN EG-A07, € 46,-
C KERN EG-A08, € 46,-
- Minimum weight of sample, smallest weight to be weighed, depending on the required process accuracy, only in combination with a DAkkS calibration certificate, KERN 969-103, € 10,-
- Equipment qualification: compliant qualification concept which includes the following validation services, Installation Qualification (IQ), Operating Qualification (OQ)
- Further details, plenty of further accessories and suitable printers see *Accessories*

STANDARD



OPTION



FACTORY



Model	Weighing capacity [Max] g	Readability [d] g	Verification value [e] g	Minimal load [Min] g	Linearity g	Weighing plate	Price excl. of VAT ex works €	Option			
								Verification KERN	€	DAkkS Calibr. Certificate DAkkS KERN	€
KERN											
EW 220-3NM	220	0,001	-	-	± 0,002	A	840,-	-	-	963-127	93,-
EW 420-3NM	420	0,001	-	-	± 0,003	A	970,-	-	-	963-127	93,-
EW 620-3NM	620	0,001	-	-	± 0,003	A	1080,-	-	-	963-103	154,-
EW 820-2NM	820	0,01	-	-	± 0,01	B	760,-	-	-	963-127	93,-
EW 2200-2NM	2200	0,01	-	-	± 0,01	C	930,-	-	-	963-127	93,-
EW 4200-2NM	4200	0,01	-	-	± 0,02	C	1030,-	-	-	963-127	93,-
EW 6200-2NM	6200	0,01	-	-	± 0,03	C	1120,-	-	-	963-104	175,-
EW 12000-1NM	12000	0,1	-	-	± 0,2	C	880,-	-	-	963-128	112,-

Note: For applications that require verification, please order verification at the same time, initial verification at a later date is not possible.

Verification at the factory, we need to know the full address of the location of use.

EG 220-3NM	220	0,001	0,01	0,02	± 0,002	A	1060,-	965-216	80,-	963-127	93,-
EG 420-3NM	420	0,001	0,01	0,02	± 0,003	A	1160,-	965-216	80,-	963-127	93,-
EG 620-3NM	620	0,001	0,01	0,1	± 0,004	A	1300,-	965-201	136,-	963-103	154,-
EG 2200-2NM	2200	0,01	0,1	0,5	± 0,01	C	1110,-	965-216	80,-	963-127	93,-
EG 4200-2NM	4200	0,01	0,1	0,5	± 0,02	C	1220,-	965-216	80,-	963-127	93,-

NEW STANDARD
★★



03

High-resolution precision balance made of stainless steel with IP protection

Features

- High-quality tuning fork measuring system for steady weight values and continuous weighing
- Thanks to the stainless steel design of the housing and platform with smooth surface, the scale is rust-free and easy to clean
- Dust and spray protection to IP65 (in accordance with EN 60529)
- Level indicator and levelling feet for precise levelling of the scale, fitted as standard
- RS-232 data interface for connection to a printer as standard
- Protective working cover included with delivery

Technical data

- Large LCD display, digit height 16,5 mm
- Dimensions weighing surface, stainless steel
 - A Ø 140 mm
 - B WxD 190x190 mm, see larger picture
- Overall dimensions WxDxH 310x208x87 mm
- Net weight approx. 1,6 kg
- Permissible ambient temperature 10 °C/30 °C

Accessories

- Loop for underfloor weighing, KERN EG-A07, **€ 46,-**
- Software BalanceConnection, for flexible recording or transmission of measured values, in particular also to Microsoft® Excel or Access as well as transfer of this data to other Apps and programs, for more details see the internet, Scope of supplies: 1 CD, 1 license, KERN SCD-4.0, **€ 189,-**
- Battery insert, enables mobile weighing, Operating time 200 h, KERN PWS-A01, **€ 110,-**
- Interface cable RS-232 to connect an external device, Dust and spray protection to IP65 (in accordance with EN 60529), KERN PWS-A02, **€ 400,-**
- Further details, plenty of further accessories and suitable printers see *Accessories*

STANDARD



OPTION



Model	Weighing capacity [Max]	Readability [d]	Reproducibility	Linearity	Weighing plate	Price excl. of VAT ex works €	Option	
							DAkKS KERN	Calibr. Certificate €
KERN PWS 800-2	820 g	0,01 g	0,01 g	± 0,01 g	A	1120,-	963-127	93,-
KERN PWS 3000-1	3200 g	0,1 g	0,1 g	± 0,1 g	B	1020,-	963-127	93,-
KERN PWS 8000-1	8200 g	0,1 g	0,1 g	± 0,1 g	B	1150,-	963-128	112,-

EXPECTED TO BE AVAILABLE FROM MARCH 2023



Multifunctional laboratory balance with single-cell weighing system, also with EC type approval [M]

Features

- KERN PBS: Adjusting program CAL for quick setting of the balance accuracy using an external test weight at an additional price, see *test weights*
- KERN PBJ: Internal adjustment in the case of a change in temperature and time-controlled at defined intervals, guarantees high degree of accuracy and makes the balance independent of its location of use
- Metal housing: robust and sturdy
- Dosage aid: High stability mode and other filter settings can be selected
- Weighing with tolerance range (checkweighing): a visual signal helps with portioning, dispensing or grading
- Totalising of weights
- Identification number: 4 digits, printed on calibration protocol freely programmable

- Automatic data output to the PC/printer each time the balance is steady
- **A** Draught shield standard for models with [d] = 0,001 g, weighing space W×D×H 180×193×87 mm
- Protective working cover included with delivery

Technical data

- Large backlit LCD display, Digit height 14 mm
- Dimensions weighing surface, stainless steel
 - A** W×D 108×105 mm
 - B** W×D 180×190 mm, see larger picture
- Overall dimensions (without draught shield) W×D×H: 209×322×78 mm
- Net weight approx. 3,2 kg
- Permissible ambient temperature 10 °C/30 °C

Accessories

- Protective working cover, scope of delivery: 5 items, for models with weighing plate size
 - A** KERN PBS-A01S05, € 44,-
 - B** KERN PBS-A02S05, € 44,-
- **1** Set for density determination of liquids and solids with density ≥ 1, for models with weighing plate size
 - A** KERN PBS-A04, € 2050,-
 - B** KERN PBS-A03, € 2050,-
- RS-232/Ethernet adapter for connection to an IP-based Ethernet network, KERN YKI-01, € 345,-
- Minimum weight of sample, smallest weight to be weighed, depending on the required process accuracy, only in combination with a DAkkS calibration certificate, KERN 969-103, € 10,-
- Equipment qualification: compliant qualification concept which includes the following validation services, Installation Qualification (IQ), Operating Qualification (OQ)
- Further details, plenty of further accessories and suitable printers see *Accessories*

2 Single-cell advanced technology:

- Fully automatic manufactured weighing cell from one piece of material
- Stable temperature behaviour
- Short stabilisation time: steady weight values within approx. 3 s under laboratory conditions
- Shock proof construction
- High corner load performance

STANDARD

--	--	--	--	--	--	--	--	--	--	--	--	--	--

PBJ PBS

OPTION

--	--

FACTORY

--

PBJ

Model	Weighing capacity [Max] g	Readability [d] g	Verification value [e] g	Minimal load [Min] g	Linearity g	Weighing plate	Price excl. of VAT ex works €	Option			
								Verification KERN	DAkkS Calibr. Certificate KERN	Dakks Certificate	
KERN PBS 620-3M	620	0,001	-	-	± 0,002	A	1820,-	-	-	963-103	154,-
PBS 4200-2M	4200	0,01	-	-	± 0,02	B	1540,-	-	-	963-127	93,-
PBS 6200-2M	6200	0,01	-	-	± 0,02	B	1850,-	-	-	963-104	175,-

Note: For applications that require verification, please order verification at the same time, initial verification at a later date is not possible.

Verification at the factory, we need to know the full address of the location of use.

PBJ 620-3M	620	0,001	0,01	0,1	± 0,002	A	2140,-	965-201	136,-	963-103	154,-
PBJ 4200-2M	4200	0,01	0,1	0,5	± 0,02	B	1900,-	965-216	80,-	963-127	93,-
PBJ 6200-2M	6200	0,01	0,1	1	± 0,02	B	2300,-	965-202	136,-	963-104	175,-
PBJ 8200-1M	8200	0,1	1	5	± 0,2	B	1890,-	965-217	93,-	963-128	112,-

PREMIUM



EasyTouch



- Net weight **A** approx. 3,6 kg, **B** approx. 4,4 kg, **C** approx. 10 kg
- Permissible ambient temperature 10 °C/30 °C

Accessories

- **A**, **B**: Protective working cover, scope of delivery: 5 items, KERN PES-A04S05, **€ 44,-**
- KERN PES: Internal rechargeable battery pack, operating time up to 32 h without backlight, charging time approx. 15 h, KERN PES-A01, **€ 690,-**
- Loop for underfloor weighing, for models with weighing plate size **B**, KERN PES-A03, **€ 43,-**
- Relay output to connect relays, signal lamps, valves etc., 5 outputs for weighing in 3 tolerance ranges, must be ordered at purchase, KERN PES-A02, **€ 550,-**
- RS-232/Ethernet adapter for connection to an IP-based Ethernet network, KERN YKI-01, **€ 345,-**
- Minimum weight of sample, smallest weight to be weighed, depending on the required process accuracy, only in combination with a DAkkS calibration certificate, KERN 969-103, **€ 10,-**
- Equipment qualification: compliant qualification concept which includes the following validation services, Installation Qualification (IQ), Operating Qualification (OQ)
- Further details, plenty of further accessories and suitable printers see *Accessories*

Robust laboratory and industrial precision scale for heavy items, also with EC type approval [M]

Features

- KERN PES: Adjusting program CAL for quick setting of the balance accuracy using an external test weight at an additional price, see *test weights*
- KERN PEJ: Automatic internal adjustment, guarantees high degree of accuracy and makes the balance independent of its location of use
- Metal housing: robust and sturdy
- Weighing with tolerance range (checkweighing): Input of two upper and two lower limit values through four arrow keys. An audible and visual signal assists with the portioning, dispensing or grading
- **T** Draught shield standard for models with [d] = 0,001 g, weighing space W×D×H 170×150×100 mm
- Underfloor weighing: load support with hook on the underside of the balance for models with [d] = 0,001 g, [d] = 0,01 g

- [d] = 0,001 g hook included with the delivery, [d] = 0,01 g/0,01 g hook not included with the delivery
- **A**, **B**: Protective working cover included with delivery

Technical data

- Fluorescent display, bright with high contrast, digit height 14 mm
- Dimensions weighing surface
 - A** W×D 140×120 mm, stainless steel
 - B** W×D 200×200 mm, stainless steel, see larger picture
 - C** W×D 250×220 mm, stainless steel
- Overall dimensions (without draught shield) W×D×H
 - A** 220×330×90 mm
 - B** 220×339×80 mm
 - C** 260×330×113 mm

STANDARD

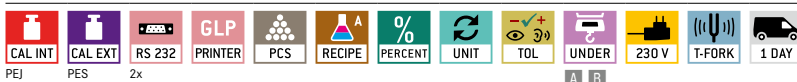

OPTION

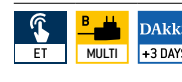

FACTORY

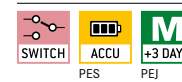

Model	Weighing capacity [Max]	Readability [d]	Verification value [e]	Minimal load [Min]	Linearity	Weighing plate	Price excl. of VAT ex works	Verification	Option
KERN	g	g	g	g	g		€	KERN	DAkkS Calibr. Certificate
								€	DAkkS KERN
PES 620-3M	620	0,001	-	-	± 0,003	A	1400,-	-	963-103 154,-
PES 2200-2M	2200	0,01	-	-	± 0,02	B	990,-	-	963-127 93,-
PES 4200-2M	4200	0,01	-	-	± 0,02	B	1180,-	-	963-127 93,-
PES 6200-2M	6200	0,01	-	-	± 0,03	B	1450,-	-	963-104 175,-
PES 15000-1M	15000	0,1	-	-	± 0,2	B	1380,-	-	963-128 112,-
PES 31000-1M	31000	0,1	-	-	± 0,4	C	2430,-	-	963-128 112,-

Note: For applications that require verification, please order verificati on at the same time, initial verification at a later date is not possible.

Verification at the factory, we need to know the full address of the location of use.

PEJ 620-3M	620	0,001	0,01	0,1	± 0,003	A	1660,-	965-201 (I)	136,-	963-103	154,-
PEJ 2200-2M	2200	0,01	0,1	0,5	± 0,02	B	1250,-	965-216 (II)	80,-	963-127	93,-
PEJ 4200-2M	4200	0,01	0,1	0,5	± 0,02	B	1430,-	965-216 (II)	80,-	963-127	93,-

NEW **PREMIUM** ★★



03

High-capacity precision balance with password-protected user administration, also with EC type approval [M]

Features

- KERN FEJ: Automatic internal adjustment, guarantees high degree of accuracy and makes the balance independent of its location of use
- KERN FES: Adjusting program CAL for quick setting of the balance accuracy using an external test weight at an additional price, see *test weights*
- Stainless steel display device with IP65 protection, hygienic and easy to clean
- Metal housing: robust and sturdy
- In order to meet requirements in the pharmaceutical industry, the balance is fitted with a user administration system, which enables unique assignment of users and protects against unauthorised access
- Intuitive concept of operation through info line on the display
- Freely-assignable function keys enable individual adjustment of the balance

- Dust and spray protection to IP65 (in accordance with EN 60529)
- U.S. FDA 21 Part 11: assists you in data integrity in accordance with U.S. FDA 21 Part 11 (for example weighing result, sample ID, user name, scales ID, ...)
- Protective working cover included with delivery

Technical data

- Large backlit LCD display, digit height 16,5 mm
- Dimensions weighing surface, stainless steel, W×D 350×400 mm
- Dimensions of display device W×D×H 290×180×60 mm
- Overall dimensions W×D×H 350×520×170 mm
- Net weight approx. 19 kg
- Permissible ambient temperature 5 °C/35 °C

Accessories

- Protective working cover, scope of delivery 5 items, KERN FEJ-A02S05, **€ 44,-**
- Relay output with 5 outputs for weighing in 3 tolerance ranges, KERN FEJ-A07, **€ 565,-**
- 1 Stand to elevate display device, height of stand approx. 700 mm, KERN FEJ-A05, **€ 160,-**
- Interface cable RS-232 to connect an external device, dust and spray protection to IP65 (in accordance with EN 60529), KERN PWS-A02, **€ 400,-**
- 2 Loop for underfloor weighing, KERN FEJ-A06, **€ 235,-**
- Further details, plenty of further accessories and suitable printers see *Accessories*

STANDARD

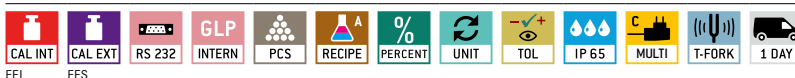

OPTION



FACTORY

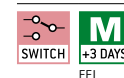

Model	Weighing capacity [Max]	Readability [d]	Verification value [e]	Minimal load [Min]	Reproducibility	Linearity	Price excl. of VAT ex works €	Verification KERN	Option DAKkS Calibr. Certificate DAKkS KERN	Certificate €
KERN	kg	g	g	g	g	g	€	M	€	€
FES 17K-4	17	0,1	-	5	0,1	± 0,3	2850,-	-	-	963-128 112,-
FES 33K-4	33	0,1	-	5	0,1	± 0,3	3000,-	-	-	963-128 112,-
FES 62K-4D	6,2 62	0,1 1	-	5	0,1 1	± 0,3 3	3300,-	-	-	963-129 139,-
Note: For applications that require verification, please order verification at the same time, initial verification at a later date is not possible.										
Verification at the factory, we need to know the full address of the location of use.										
FEJ 17K-4M	17	0,1	1	5	0,1	± 0,3	3080,-	965-217	93,-	963-128 112,-
FEJ 33K-4M	33	0,1	1	5	0,1	± 0,3	3340,-	965-217	93,-	963-128 112,-
FEJ 62K-4DM	6,2 62	0,1 1	1	5	0,1 1	± 0,3 3	3650,-	965-218	125,-	963-129 139,-

1 EXPECTED TO BE AVAILABLE FROM MARCH 2023

04



ANALYTICAL BALANCES

Quick-Finder Analytical balances

Readability [d] mg	Weighing capacity [Max] g	Model KERN	Price excl. of VAT ex works €	Page								
For an explanation on the pictos, see front flap												
0,01	101	ABT 100-5NM	2540,-	44	1	●	●	●	●	●	●	●
0,01	135	ABP 100-5M	4290,-	46	1	●	●	●	●	●	●	●
0,01	135	ABP 100-5AM	9230,-	48	1	●	●	●	●	●	●	●
0,01	210	ALJ 210-5A	3600,-	40	1	●	●	●	●	●	●	●
0,01	220	ABP 200-5M	6070,-	46	1	●	●	●	●	●	●	●
0,01	220	ABP 200-5AM	11300,-	48	1	●	●	●	●	●	●	●
0,01 0,1	42 120	ABT 120-5DNM	2570,-	44	1	●	●	●	●	●	●	●
0,01 0,1	52 120	ABP 100-5DM	3260,-	46	1	●	●	●	●	●	●	●
0,01 0,1	52 120	ABP 100-5DAM	6850,-	48	1	●	●	●	●	●	●	●
0,01 0,1	82 220	ALJ 200-5DA	2470,-	40	1	●	●	●	●	●	●	●
0,01 0,1	82 220	ABT 220-5DNM	2650,-	44	1	●	●	●	●	●	●	●
0,01 0,1	102 220	ABP 200-5DM	3490,-	46	1	●	●	●	●	●	●	●
0,01 0,1	102 220	ABP 200-5DAM	9050,-	48	1	●	●	●	●	●	●	●
0,1	82	ABS 80-4N	1270,-	42	1	●	●	●	○	●	●	●
0,1	82	ACS 80-4	1290,-	42	1	●	●	●	●	●	●	●
0,1	82	ABJ 80-4NM	1430,-	42	1	●	●	●	○	●	●	●
0,1	82	ACJ 80-4M	1450,-	42	1	●	●	●	●	●	●	●
0,1	82	ADB 600-C3	810,-	39	1	●	●	●	●	●	●	●
0,1	120	ADB 100-4	820,-	39	1	●	●	●	●	●	●	●
0,1	120	ADJ 600-C3	970,-	39	1	●	●	●	●	●	●	●
0,1	120	ADJ 100-4	980,-	39	1	●	●	●	●	●	●	●
0,1	120	ABS 120-4N	1370,-	42	1	●	●	●	○	●	●	●
0,1	120	ACS 100-4	1390,-	42	1	●	●	●	●	●	●	●
0,1	120	ABJ 120-4NM	1470,-	42	1	●	●	●	○	●	●	●
0,1	120	ACJ 100-4M	1490,-	42	1	●	●	●	●	●	●	●
0,1	120	ABT 120-4NM	1940,-	44	1	●	●	●	●	●	●	●
0,1	120	ABP 100-4M	2240,-	46	1	●	●	●	●	●	●	●
0,1	160	ALS 160-4A	1510,-	40	1	●	●	●	●	●	●	●
0,1	160	ALJ 160-4A	1620,-	40	1	●	●	●	●	●	●	●
0,1	160	ALJ 160-4AM	1660,-	40	1	●	●	●	●	●	●	●
0,1	220	ADB 200-4	910,-	39	1	●	●	●	●	●	●	●
0,1	220	ADJ 200-4	1070,-	39	1	●	●	●	●	●	●	●
0,1	220	ABS 220-4N	1470,-	42	1	●	●	●	○	●	●	●
0,1	220	ACS 200-4	1490,-	42	1	●	●	●	●	●	●	●
0,1	220	ABJ 220-4NM	1570,-	42	1	●	●	●	○	●	●	●
0,1	220	ACJ 200-4M	1590,-	42	1	●	●	●	●	●	●	●
0,1	220	ABT 220-4NM	2350,-	44	1	●	●	●	●	●	●	●
0,1	220	ABP 200-4M	2710,-	46	1	●	●	●	●	●	●	●
0,1	220	ABP 200-4AM	5990,-	48	1	●	●	●	●	●	●	●
0,1	250	ALS 250-4A	1560,-	40	1	●	●	●	●	●	●	●
0,1	250	ALJ 250-4A	1690,-	40	1	●	●	●	●	●	●	●
0,1	250	ALJ 250-4AM	1730,-	40	1	●	●	●	●	●	●	●
0,1	310	ALJ 310-4A	1750,-	40	1	●	●	●	●	●	●	●
0,1	320	ABS 320-4N	1670,-	42	1	●	●	●	○	●	●	●
0,1	320	ACS 300-4	1690,-	42	1	●	●	●	●	●	●	●
0,1	320	ABJ 320-4NM	1820,-	42	1	●	●	●	○	●	●	●
0,1	320	ACJ 300-4M	1850,-	42	1	●	●	●	●	●	●	●
0,1	320	ABT 320-4NM	2610,-	44	1	●	●	●	●	●	●	●
0,1	320	ABP 300-4M	3020,-	46	1	●	●	●	●	●	●	●
0,1	320	ABP 300-4AM	6490,-	48	1	●	●	●	●	●	●	●
0,1	510	ALJ 500-4A	2470,-	40	1	●	●	●	●	●	●	●



The price leader in analytical balances, with internal or external adjustment - now as version with [Max] 220 g!

Features

- ADB 200-4: Model with incredibly high resolution. Ideal if extremely precise weighing is required
- KERN ADJ: Automatic internal adjustment in the case of a change in temperature $\geq 2\text{ }^{\circ}\text{C}$ or timecontrolled every 3 h, guarantees high degree of accuracy and makes the balance independent of its location of use
- KERN ADB: Adjusting program CAL for quick setting of the balance accuracy using an external test weight at an additional price, see *test weights*
- **1** ADJ 600-C3 / ADB 600-C3: Compact, space-saving carat balances with a readout of 0.001 ct and a weighing range of 600 ct. The high level of accuracy saves hard cash wherever you are weighing valuable precious stones
- Level indicator and levelling feet for precise levelling of the scale, fitted as standard, to give the most accurate weighing result

- Large glass draught shield with 3 sliding doors for easy access to the items being weighed standard
- Compact size, practical for small spaces
- Simple and convenient 6-key operation

Technical data

- Large backlit LCD display, digit height 16 mm
- Dimensions weighing surface, stainless steel, \varnothing 90 mm
- Overall dimensions (incl. draught shield) W×D×H
KERN ADB/ADJ: 230×310×330 mm
KERN ADB-C/ADJ-C: 230×310×210 mm
- Weighing space W×D×H
KERN ADB/ADJ: 170×160×205 mm
KERN ADB-C/ADJ-C: 170×160×110 mm
- Permissible ambient temperature 10 °C/30 °C

Accessories

- **2** Set for density determination of liquids and solids with density $\leq/\geq 1$, the density is indicated directly on the display, KERN YDB-03, **€ 380,-**
- **3** Ioniser to neutralise electrostatic charge, KERN YBI-01A, **€ 1050,-**
- **4** Gemstones plate, aluminium with practical spout, W×D×H 130×80×30 mm, KERN AEJ-A05, **€ 43,-**
- **5** Weighing table to absorb vibrations and oscillations, which would otherwise distort the weighing result, KERN YPS-03, **€ 1060,-**
- Minimum weight of sample, smallest weight to be weighed, depending on the required process accuracy, only in combination with a DAkkS calibration certificate, KERN 969-103, **€ 10,-**
- Equipment qualification: compliant qualification concept which includes the following validation services, Installation Qualification (IQ), Operating Qualification (OQ), for details see page 216
- Further details, plenty of further accessories and suitable printers see *Accessories*

STANDARD OPTION

CAL INT	CAL EXT	RS 232	GLP	PC	PERCENT	UNIT	MULTI	FORCE	1 DAY	ET	DAkkS
ADB	ADB										+3 DAYS

Model	Weighing capacity	Readability	Reproducibility	Linearity	Net weight	Price	Option	
							DAkkS	Certificate
	[Max]	[d]			approx.	excl. of VAT	DAkkS	€
KERN	g	mg	mg	mg	kg	€	KERN	€
ADB 100-4	120	0,1	0,2	± 0,4	4,4	820,-	963-101	182,-
ADB 200-4	220	0,1	0,2	± 0,4	4,4	910,-	963-101	182,-
ADB 600-C3	600 ct	0,001 ct	0,002 ct	± 0,004 ct	3,8	810,-	963-101	182,-
ADJ 100-4	120	0,1	0,2	± 0,4	5	980,-	963-101	182,-
ADJ 200-4	220	0,1	0,2	± 0,4	5	1070,-	963-101	182,-
ADJ 600-C3	600 ct	0,001 ct	0,002 ct	± 0,004 ct	4,5	970,-	963-101	182,-

= Carat balances



04



KERN ALJ 200-5DA with optional ioniser **1**, see *accessories*. High-precision semi-micro analytical balance. Thanks to its high level of precision, it is ideal for calibrating pipettes
 Note: To prevent evaporation we recommend economical capillary tubes (see standard 8655)

Analytical balances with a large weighing range, graphics display and user-friendly recipe weighing function - now also as single-range semi-micro balance with unbelievably high resolution

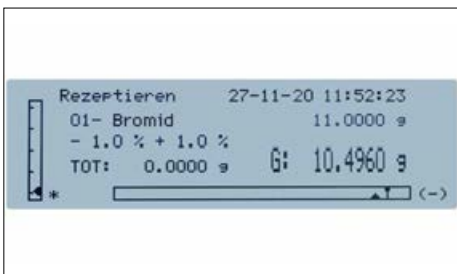

Convenient recipe-weighing: with the recipe database, in which up to 99 recipes can be stored, each with up to 20 recipe ingredients with name and target value



Clear printout with date and time. In addition, the components of the mixture are numbered automatically and printed out with the name & and weight

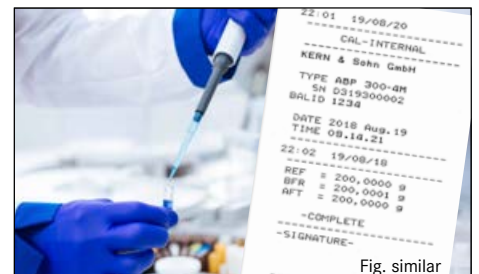

GLP/ISO record keeping, professional, detailed GLP Protocol, so that the balance is completely compliant with the relevant standard requirements in accordance with ISO, GLP and GMP



Features

- ALJ 210-5A: Semi-micro model with just one weighing range with unbelievably high resolution, ideal where heavy items need to be weighed with the most accurate readout across the entire weighing range. Particularly advantageous: an ioniser for neutralising electrostatic charge is already fitted as standard
- Rapid and efficient operation thanks to the graphics display. Simple, clear user interface on the display in the following languages: DE, EN, FR, IT, ES, PT
- KERN ALJ-A03: Ionizer to neutralise electrostatic charge for fixed installation in the analytical balance. Particularly convenient handling as you no longer need a separate device. Simply enable the ionizer fan at the push of a button. Suitable for all models, see accessories Already fitted as standard in the model KERN ALJ 210-5A
- KERN ALS-A: Adjusting program CAL for quick setting of the balance accuracy using an external test weight at an additional price, see *test weights*
- Short stabilisation time: steady weight values within approx. 4 s under laboratory conditions
- Weighing with tolerance range (checkweighing): Input of an upper/lower limit value. A visual signal assists with portioning, dispensing or grading

- Dosage aid: High stability mode and other filter settings can be selected
- Internal memory for complete recipes with name and target value of the recipe ingredients. User guidance through display
- Ergonomically optimised keypad for left and righthanded users
- Large glass draught shield with 3 sliding doors for easy access to the items being weighed
- Compact size, practical for small spaces
- Protective working cover included with delivery

Technical data

- Backlit LCD Graphic display, digit height 15 mm
- Dimensions weighing surface, stainless steel, \varnothing 80 mm
- Weighing space W×D×H 160×170×225 mm
- Overall dimensions (incl. draught shield) W×D×H 210×340×330 mm
- Net weight approx. 7 kg
- Permissible ambient temperature 5 °C/35 °C

Accessories

- Protective working cover, scope of delivery 5 items, KERN ALJ-A01S05, € 44,-
- Protective dust cover, KERN ABS-A08, € 32,-
- KERN ALJ: Evaporation trap, minimises faults through evaporation when using pipettes for small volumes of 10 μ l to 10 ml, KERN ALJ-A02, € 770,-

- **1** Draft shield rear panel with integrated ionizer to neutralise electrostatic charge. Is fitted in place of the existing glass rear panel of the draft shield. Suitable for all models in the range, please order at the time you order your balance, the scope of delivery is the rear panel, ionizer, Universal plug-in power supply. Factory Option, KERN ALJ-A03, € 670,-
- **2** Set for density determination of liquids and solids with density \leq/\geq 1, the density is indicated directly on the display, KERN YDB-03, € 380,-
- **3** Weighing table to absorb vibrations and oscillations, which would otherwise distort the weighing result, KERN YPS-03, € 1060,-
- Minimum weight of sample, smallest weight to be weighed, depending on the required process accuracy, only in combination with a DAkkS calibration certificate, KERN 969-103, € 10,-
- Equipment qualification: compliant qualification concept which includes the following validation services, Installation Qualification (IQ), Operating Qualification (OQ), for details see page 216
- Further details, plenty of further accessories and suitable printers see *Accessories*

04

STANDARD

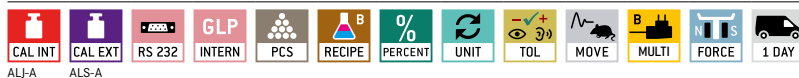

OPTION



FACTORY



Model	Weighing capacity [Max] g	Readability [d] mg	Verification value [e] mg	Minimal load [Min] mg	Reproducibility mg	Linearity mg	Price excl. of VAT ex works €	Option			
								Verification M1 KERN €	DAkkS €	Calibr. Certificate DAkkS KERN €	
KERN											
ALS 160-4A	160	0,1	-	-	0,1	± 0,3	1510,-	-	-	963-101 182,-	
ALS 250-4A	250	0,1	-	-	0,1	± 0,3	1560,-	-	-	963-101 182,-	
ALJ 210-5A	210	0,01	-	-	0,05	± 0,1	3600,-	-	-	963-101 182,-	
ALJ 160-4A	160	0,1	-	-	0,1	± 0,3	1620,-	-	-	963-101 182,-	
ALJ 250-4A	250	0,1	-	-	0,1	± 0,3	1690,-	-	-	963-101 182,-	
ALJ 310-4A	310	0,1	-	-	0,1	± 0,3	1750,-	-	-	963-101 182,-	
ALJ 500-4A	510	0,1	-	-	0,2	± 0,4	2470,-	-	-	963-101 182,-	
Multi-range balance, with increasing load it switches automatically to the next largest weighing range [Max] and readout [d] and when the load is fully removed, the balance switches back to the lower range											
ALJ 200-5DA	82 220	0,01 0,1	-	-	0,04 0,1	± 0,1 0,2	2470,-	-	-	963-101 182,-	
Note: For applications that require verification, please order verification at the same time, initial verification at a later date is not possible.											
Verification at the factory, we need to know the full address of the location of use.											
ALJ 160-4AM	160	0,1	1	10	0,1	± 0,3	1660,-	965-201 136,-	963-101	182,-	
ALJ 250-4AM	250	0,1	1	10	0,1	± 0,3	1730,-	965-201 136,-	963-101	182,-	



04



KERN ACS/ACJ with standard data interface RS-232 and USB data interface

The bestseller in analytical balances, with high-quality single-cell weighing system, also with EC type approval [M]

Features

- KERN ABJ-NM, ACJ: Automatic internal adjustment in the case of a change in temperature $\geq 2\text{ }^{\circ}\text{C}$ or timecontrolled every 4 h, guarantees high degree of accuracy and makes the balance independent of its location of use
- KERN ABS-N, ACS: Adjusting program CAL for quick setting of the balance accuracy using an external test weight at an additional price, see *test weights*
- Dosage aid: High stability mode and other filter settings can be selected
- Simple recipe weighing and documenting with a combined tare/print function. In addition, the ingredients for the recipe are numbered automatically and printed out with their corresponding number and nominal weight
- Automatic data output to the PC/printer each time the balance is steady
- Identification number: 4 digits, printed on calibration protocol freely programmable
- Protective working cover included with delivery



Technical data

- Large LCD display, digit height 14 mm
- Dimensions weighing surface, stainless steel, \varnothing 91 mm
- Weighing space W×D×H 174×162×227 mm
- Overall dimensions (incl. draught shield) W×D×H 213×333×338 mm
- Net weight approx. 6 kg
- Permissible ambient temperature 10 °C/30 °C

Accessories

- Protective working cover, scope of delivery 5 items, KERN ACS-A02S05, € 44,-
- 1 Set for density determination of liquids and solids with density \leq/\geq 1, the density is indicated directly on the display, KERN YDB-03, € 380,-
- 2 Ioniser to neutralise electrostatic charge, KERN YBI-01A, € 1050,-
- KERN ABS-N/ABJ-NM: Data interface RS-232, interface cable included, approx. 1,5 m, KERN ACS-A01, € 115,-
- 3 Weighing table to absorb vibrations and oscillations, which would otherwise distort the weighing result, KERN YPS-03, € 1060,-
- Minimum weight of sample, smallest weight to be weighed, depending on the required process accuracy, only in combination with a DAkkS calibration certificate, KERN 969-103, € 10,-
- Equipment qualification: compliant qualification concept which includes the following validation services, Installation Qualification (IQ), Operating Qualification (OQ), for details see page 216
- Further details, plenty of further accessories and suitable printers see *Accessories*



Single-cell advanced technology:

- Fully automatic manufactured weighing cell from one piece of material
- Stable temperature behaviour
- Short stabilisation time: steady weight values within approx. 3 s under laboratory conditions
- Shock proof construction
- High corner load performance

04

STANDARD



OPTION

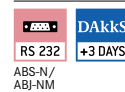

FACTORY



Model	Weighing capacity [Max]	Readability	Verification value	Minimal load	Reproducibility	Linearity	Price excl. of VAT ex works	Verification	Option	DAkkS Calibr. Certificate
KERN	g	[d] mg	[e] mg	[Min] mg	mg	mg	€	MET KERN	€	DAkkS KERN
ABS 80-4N	82	0,1	-	-	0,2	± 0,3	1270,-	-	-	963-101 182,-
ABS 120-4N	120	0,1	-	-	0,2	± 0,3	1370,-	-	-	963-101 182,-
ABS 220-4N	220	0,1	-	-	0,2	± 0,3	1470,-	-	-	963-101 182,-
ABS 320-4N	320	0,1	-	-	0,2	± 0,3	1670,-	-	-	963-101 182,-
ACS 80-4	82	0,1	-	-	0,2	± 0,3	1290,-	-	-	963-101 182,-
ACS 100-4	120	0,1	-	-	0,2	± 0,3	1390,-	-	-	963-101 182,-
ACS 200-4	220	0,1	-	-	0,2	± 0,3	1490,-	-	-	963-101 182,-
ACS 300-4	320	0,1	-	-	0,2	± 0,3	1690,-	-	-	963-101 182,-
ABJ 80-4NM	82	0,1	-	-	0,2	± 0,3	1430,-	-	-	963-101 182,-
ABJ 120-4NM	120	0,1	-	-	0,2	± 0,3	1470,-	-	-	963-101 182,-
ABJ 220-4NM	220	0,1	-	-	0,2	± 0,3	1570,-	-	-	963-101 182,-
ABJ 320-4NM	320	0,1	-	-	0,2	± 0,3	1820,-	-	-	963-101 182,-

Note: For applications that require verification, please order verification at the same time, initial verification at a later date is not possible.

Verification at the factory, we need to know the full address of the location of use.

ACJ 80-4M	82	0,1	1	10	0,2	± 0,3	1450,-	965-201	136,-	963-101	182,-
ACJ 100-4M	120	0,1	1	10	0,2	± 0,3	1490,-	965-201	136,-	963-101	182,-
ACJ 200-4M	220	0,1	1	10	0,2	± 0,3	1590,-	965-201	136,-	963-101	182,-
ACJ 300-4M	320	0,1	1	10	0,2	± 0,3	1850,-	965-201	136,-	963-101	182,-



The premium model with single-cell weighing system

Features

- Automatic internal adjustment in the case of a change in temperature $\geq 0,5\text{ }^{\circ}\text{C}$ or timecontrolled every 4 h, guarantees high degree of accuracy and makes the balance independent of its location of use
- Dosage aid: High stability mode and other filter settings can be selected
- Simple recipe weighing and documenting with a combined tare/print function. In addition, the ingredients for the recipe are numbered automatically and printed out with their corresponding number and nominal weight
- Identification number: 4 digits, printed on calibration protocol freely programmable
- Printout of a GLP-compliant calibration report conveniently at the touch of a button
- Automatic data output to the PC/printer each time the balance is steady
- Large glass draught shield with 3 sliding doors for easy access to the items being weighed

- Protective working cover included with delivery

Technical data

- Large LCD display, digit height 14 mm
- Dimensions weighing surface \varnothing 80 mm, stainless steel
- Weighing space W×D×H 168×172×223 mm
- Overall dimensions (incl. draught shield) W×D×H 217×356×338 mm
- Net weight approx. 7 kg
- Permissible ambient temperature 10 $^{\circ}\text{C}$ /30 $^{\circ}\text{C}$

Accessories

- Protective working cover, scope of delivery 5 items, KERN ABT-A02S05, **€ 44,-**
- Set for density determination of liquids and solids with density $\leq/\geq 1$, the density is indicated directly on the display, KERN YDB-03, **€ 380,-**

- Ioniser to neutralise electrostatic charge, KERN YBI-01A, **€ 1050,-**
- Weighing table to absorb vibrations and oscillations, which would otherwise distort the weighing result, KERN YPS-03, **€ 1060,-**
- Minimum weight of sample, smallest weight to be weighed, depending on the required process accuracy, only in combination with a DAkkS calibration certificate, KERN 969-103, **€ 10,-**
- Equipment qualification: compliant qualification concept which includes the following validation services, Installation Qualification (IQ), Operating Qualification (OQ), for details see page 216
- Further details, plenty of further accessories and suitable printers see *Accessories*

Single-cell advanced technology:

- **Fully automatic manufactured weighing cell from one piece of material**
- **Stable temperature behaviour**
- **Short stabilisation time:** steady weight values within approx. 4 s (models with [d] = 0,1 mg), approx. 10 s (models with [d] = 0,01 mg) under laboratory conditions
- **Shock proof construction**
- **High corner load performance**

STANDARD

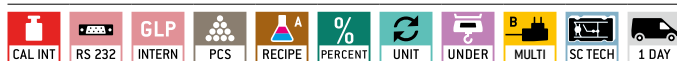

OPTION



FACTORY



Model	Weighing capacity [Max]	Readability [d]	Verification value [e] mg	Minimal load [Min] mg	Reproducibility mg	Linearity mg	Price excl. of VAT ex works €	Option					
								Verification	DAkkS	Calibr. Certificate	Dakks		
KERN	g	mg						KERN	€	KERN	€		
ABT 100-5NM	101	0,01	1	1	0,05	$\pm 0,15$	2540,-	965-201	136,-	963-101	182,-		
ABT 120-4NM	120	0,1	1	10	0,1	$\pm 0,2$	1940,-	965-201	136,-	963-101	182,-		
ABT 220-4NM	220	0,1	1	10	0,1	$\pm 0,2$	2350,-	965-201	136,-	963-101	182,-		
ABT 320-4NM	320	0,1	1	10	0,1	$\pm 0,3$	2610,-	965-201	136,-	963-101	182,-		
Multi-range balance, with increasing load it switches automatically to the next largest weighing range [Max] and readout [d] and when the load is fully removed, the balance switches back to the lower range													
ABT 120-5DNM	42 120	0,01 0,1	1 1	1	0,02 0,1	$\pm 0,05$ 0,2	2570,-	965-201	136,-	963-101	182,-		
ABT 220-5DNM	82 220	0,01 0,1	1 1	1	0,05 0,1	$\pm 0,1$ 0,2	2650,-	965-201	136,-	963-101	182,-		

Note: For applications that require verification, please order verification at the same time, initial verification at a later date is not possible.

Verification at the factory, we need to know the full address of the location of use.

ALL-ROUND SECURITY IN DAILY LABORATORY LIFE

For quality assurance and easy, compliant sequences in the laboratory, KERN offers you an extensive range of services and plenty of suitable accessories – we will be happy to advise you.

THE BENEFIT OF KERN ACCESSORIES:

Count on it – everything fits together! Our product advisors can recommend the fitting accessories for your KERN devices, so that your individual weighing systems seamlessly work together in a stable and reliable way.



All details on DAkkS calibration certificates for test weights, our KERN calibration service and other useful information can be found here: www.kern-lab.com

Our accessory tips for all KERN laboratory balances

For **thermal printer**, KERN YKB-01 or other suitable printers, see page 170



Draft shield rear panel with integrated ioniser, to neutralise electrostatic charge, guarantees extremely rapid ionisation, KERN ABP-A01, see page 47/48

Solid weighing table

Professionalism and security for a stable weighing environment. Suitable for all laboratory balances, KERN YPS-03, see page 180



→ Didn't find the right product in the catalogue?

You can find the full range of accessories and available KERN test equipment in our online shop www.kern-sohn.com

LOOKING FOR THE RIGHT TEST EQUIPMENT?

Sit back and relax! You will find that we have an enormous range of test weights and suitable calibration services - all in accordance with the current DAkkS guidelines.

For example, discover our DAkkS-calibrated KERN Safety Sets each with an appropriate test weight for correct adjusting of the balance, a small test weight for checking the minimum sample weight, plus space for another separate test weight.

Extensive details on all topics can be found on page 182.





04



2 KERN ABP 100-5DM with optional ionisor

Premium analytical balance with the latest Single-Cell Generation for extremely rapid, stable weighing results - now also as a version with automatic sliding doors



1 The internal draft shield minimises the effect of currents of air in the weighing chamber and therefore significantly improves the stabilisation time and repeatability.



2 Draft shield rear panel with integrated ionisor, which can be fitted in place of the existing glass rear panel of the draft shield



GLP/ISO record keeping, professional, detailed GLP Protocol, so that the balance is completely compliant with the relevant standard requirements in accordance with ISO, GLP and GMP

Features



- NEW: KERN ABP-A: with 3 automatic sliding doors, which can be opened and closed using sensors, and integrated ioniser as standard. Thanks to the Memory Function, the balance stores how far the sliding doors have been opened. This prevents contamination and accelerates processes. Touching the sliding doors “gently” activates the push function and the doors open and shut automatically. The adjustable internal draft shield guarantees maximum stability of the weight readings
- This new generation of analytical balances combines the highest level of precision with large weighing ranges. Thanks to the new Single-Cell Generation, the weighing result is displayed in a fraction of the time with comparable models. Together with the intuitively structured menu, this means that you can work efficiently and rapidly
- Navigation pad for super quick navigating through the menus
- Automatic internal adjustment in the case of a change in temperature $\geq 1\text{ }^{\circ}\text{C}$ or timecontrolled every 4 h, guarantees high degree of accuracy and makes the balance independent of its location of use
- The Minimum weight of sample can be manually stored in the device or automatically calculated. For weighings below this value, the balance issues a warning message
- Dosage aid: High stability mode and other filter settings can be selected
- Simple recipe weighing and documenting with a combined tare/print function. In addition, the ingredients for the recipe are numbered automatically and printed out with their corresponding number and nominal weight
- Individual user settings can be stored for up to 10 users: user name/number (can be printed out or added to the record for each process), password, menu language, user profiles, accessing user settings via barcode, additional guest mode for users who are not logged in, authorizations, e.g.

- B. balance adjustment, changing settings or conditioning or modification of a recipe only by the authorized person & performing the formulation by the user
- RS-232 data interfaces and USB (device) for transferring weighing data and USB (host) to connect a USB keyboard for easy capture of item numbers, recipes, for easier navigation within the menu etc.
- U.S. FDA 21 Part 11: assists you in data integrity in accordance with U.S. FDA 21 Part 11 (for example weighing result, sample ID, user name, scales ID, ...)
- Menu languages DE, EN
- Automatic data output to the PC/printer each time the balance is steady
- Large glass draught shield with 3 sliding doors for easy access to the items being weighed
- [d] = 0,01 mg: Multi-function weighing plate included with delivery, minimises the effect of currents of air in the weighing chamber and therefore significantly improves the stabilisation time and repeatability. In addition samples, sample paper, PCR containers, micro centrifuge tubes and many other items which protrude can be easily fixed in place and weighed easily
- Protective working cover included with delivery

Technical data

- Luminescent OLED display, digit height 12 mm, bright with high contrast, for easy reading of the weight, even in poor lighting conditions
- Dimensions weighing surface \varnothing 91 mm, stainless steel
- Weighing space WxDxH 166x156x220 mm
- Overall dimensions WxDxH 213x433x344 mm
- Net weight approx. 8 kg
- Permissible ambient temperature 10 $^{\circ}\text{C}$ /30 $^{\circ}\text{C}$

Accessories

- Protective working cover, scope of delivery 5 items, KERN YBA-A06S05, **€ 44,-**
- Set for density determination of liquids and solids with density $\leq/\geq 1$, the density is indicated directly on the display, KERN YDB-03, **€ 380,-**
-  Internal windbreak plate made of glass, KERN ABP-A02, **€ 165,-**
-  Draft shield rear panel with integrated ionizer to neutralise electrostatic charge. Is fitted in place of the existing glass rear panel of the draft shield. Suitable for all models in the range, please order at the time you order your balance, the scope of delivery is the rear panel, ionizer, Universal plug-in power supply. Factory Option, KERN ABP-A01, **€ 1990,-**
- USB barcode scanner, hand-held version, dimensions WxDxH 152x84x63 mm, KERN PET-A09, **€ 380,-**
- Minimum weight of sample, smallest weight to be weighed, depending on the required process accuracy, only in combination with a DAkkS calibration certificate, KERN 969-103, **€ 10,-**
- Equipment qualification: compliant qualification concept which includes the following validation services, Installation Qualification (IQ), Operating Qualification (OQ), for details see page 216
- Further details, plenty of further accessories and suitable printers see *Accessories*

Single-cell advanced technology:

- **Fully automatic manufactured weighing cell from one piece of material**
- **Stable temperature behaviour**
- **Short stabilisation time:** steady weight values within approx. 2 s (models with [d] = 0,1 mg), approx. 8 s (models with [d] = 0,01 mg, 0,01 | 0,1 mg) under laboratory conditions
- **Shock proof construction**
- **High corner load performance**

STANDARD

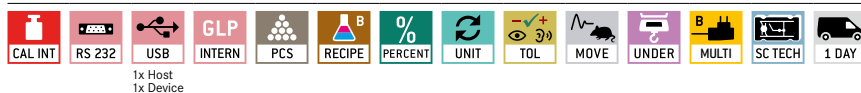

OPTION

FACTORY



Model	Weighing capacity [Max] g	Readability [d] mg	Verification value [e] mg	Minimal load [Min] mg	Reproducibility mg	Linearity mg	Price excl. of VAT ex works €	Option			
								Verification  KERN	DAkkS €	Calibr. Certificate DAkkS KERN €	
ABP 100-5M	135	0,01	1	1	0,05	$\pm 0,2$	4290,-	965-201	136,-	963-101	182,-
ABP 200-5M	220	0,01	1	1	0,05	$\pm 0,2$	6070,-	965-201	136,-	963-101	182,-
ABP 100-4M	120	0,1	1	10	0,1	$\pm 0,2$	2240,-	965-201	136,-	963-101	182,-
ABP 200-4M	220	0,1	1	10	0,1	$\pm 0,2$	2710,-	965-201	136,-	963-101	182,-
ABP 300-4M	320	0,1	1	10	0,2	$\pm 0,3$	3020,-	965-201	136,-	963-101	182,-
Multi-division balance, with increasing or decreasing load, it switches automatically to the next largest or smallest weighing range [Max] and readout [d].											
ABP 100-5DM	52 120	0,01 0,1	1 1	1	0,02 0,1	$\pm 0,05$ 0,2	3260,-	965-201	136,-	963-101	182,-
ABP 200-5DM	102 220	0,01 0,1	1 1	1	0,05 0,1	$\pm 0,1$ 0,2	3490,-	965-201	136,-	963-101	182,-

Note: For applications that require verification, please order verification at the same time, initial verification at a later date is not possible.

Verification at the factory, we need to know the full address of the location of use.

Analytical balance KERN ABP-A – Features & accessories of the new models



Automatic sliding doors, which can be opened and closed using sensors



NEW

PREMIUM
★ ★ ★



Ioniser (included) can be activated at the touch of a button



Opening possible alternatively via button



Erlenmeyer piston holder, included as standard with ABP 200-5M and ABP 200-5AM



Internal draft shield - minimises the effect of air currents in the weighing chamber, only for 0.01 mg models of the ABP-A series



Multi-function weighing plate included with delivery for models with [d] = 0,01 mg

KERN ABP-A with integrated ioniser and internal draft shield

STANDARD

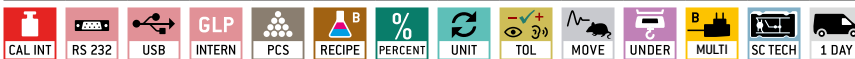

1x Host
1x Device

OPTION FACTORY



Model	Weighing capacity [Max] g	Readability [d] mg	Verification value [e] mg	Minimal load [Min] mg	Reproducibility mg	Linearity mg	Price excl. of VAT ex works €	Option			
								Verification M D KERN	DAkKS Calibr. KERN	Certificate DAkKS	
ABP 100-5AM <small>NEW</small>	135	0,01	1	1	0,05	± 0,2	9230,-	965-201	136,-	963-101	182,-
ABP 200-5AM <small>NEW</small>	220	0,01	1	1	0,05	± 0,2	11300,-	965-201	136,-	963-101	182,-
ABP 200-4AM <small>NEW</small>	220	0,1	1	10	0,1	± 0,2	5990,-	965-201	136,-	963-101	182,-
ABP 300-4AM <small>NEW</small>	320	0,1	1	10	0,2	± 0,3	6490,-	965-201	136,-	963-101	182,-
Multi-division balance, with increasing or decreasing load, it switches automatically to the next largest or smallest weighing range [Max] and readout [d].											
ABP 100-5DAM <small>NEW</small>	52 120	0,01 0,1	1 1	1	0,02 0,1	± 0,05 0,2	6850,-	965-201	136,-	963-101	182,-
ABP 200-5DAM <small>NEW</small>	102 220	0,01 0,1	1 1	1	0,05 0,1	± 0,1 0,2	9050,-	965-201	136,-	963-101	182,-

Note: For applications that require verification, please order verification at the same time, initial verification at a later date is not possible.

Verification at the factory, we need to know the full address of the location of use.

NEW New model

05 MOISTURE ANALYSERS



They have a number of memories, network connectivity, different heating modes and are easy to use due to the intuitive operation and easy-to-read displays. Our high-quality moisture analysers are ideal for use in the food processing industry, water resource management, plastics industry, the energy industry or agriculture.

Halogen moisture analysers for rapid, reliable measuring results

Our models work on the thermogravimetric principle which means the sample is weighed and warmed with a halogen lamp. During this procedure, the weight loss is recorded continuously while it is drying until it reaches the defined value. The current moisture content for the sample can then be automatically calculated from the measured weight difference.

All benefits of our moisture analysers with halogen and infra-red drying:

- Even heating of the sample without risk of burning
- Rapid amortisation through low purchase costs
- Temperature ranges from 35 to 200 degrees
- High level of measurement accuracy to 0.01 %
- Spare capacity, weighing range up to 200 g
- You can select between different heating profiles
- You can select between different switch-off criteria, automatic or time-controlled

The drying programs

Depending on the model, our moisture analysers have different heating profiles, so the procedure can be adapted to best suit the sample in question.

- The standard drying setting is suitable for most types of sample. As an option you can choose between these two types of switch-off criteria: Automatic drying (AUTO) or time-controlled (TIME).
- Rapid drying is suitable for samples with a high moisture content.
- Smooth heating through gentle drying prevents disintegration and formation of a skin
- As an alternative to rapid drying, you can also use stage drying as well. The temperature and the time period for the increase in temperature can be freely selected. Equally, the moisture can be determined selectively for different temperatures.

Our recommendation: The high-performance DBS moisture analyser with excellent stability, reliability and reaction speed, 10 drying programs can be stored and memory for 100 drying processes carried out as well as a USB and RS 232 data interface.

Simple data transfer

For easy, convenient communication between the moisture analyser and printer, or PC there are interfaces available, for example to connect a USB or Ethernet. The devices themselves have several internal memories, where you can store drying programs with drying parameters, such as, for example, drying period, drying temperature, display settings, switch-off criteria etc. This saves time and guarantees repeatable results. Compatible printers to print out weights, calibration and interface kits are available in our extensive range of accessories, suitable for each moisture analyser.





For communication between the balance and the printer, the moisture analyser must be disconnected from the power supply and connected to the printer. We guarantee fault-free operation with the KERN interface cable. To transfer the values to the PC we recommend our "Balance Connection KERN SCD 4.0" transfer software. Programs such as Excel or other spreadsheet applications are ideal for displaying graphics.

Our recommendation: DLB moisture analyser with intuitive graphics display, multi-lingual user guidance, convenient Auto-Tare when closing the lid and RS 232 data interface

Our service options

In order for the comparability of the results of moisture analyses to be guaranteed, the correct temperatures must be maintained in the heating chamber or sample. We offer our customers regular calibration of the temperature for genuine and reliable measuring results KERN 964-305, € 174,-. If requested, we can carry out sample analysis for you and support you in adjusting the parameters of your moisture analyser KERN 965-243, € 95,-/hour. Please contact your personal customer advisor if you would like us to help!

Quick-Finder Moisture analysers

Readability [d] g	Weighing capacity [Max] g	Model KERN	Price excl. of VAT ex works €	Page	 DAYS	 CAL EXT	 MEMORY	 RS 232
0,001	60	DBS 60-3	1750,-	51	1	●	●	●
0,001	110	DAB 100-3	1290,-	50	1	●	●	●
0,001	160	DLB 160-3A	1655,-	52	1	●	●	●
0,01	200	DAB 200-2	1240,-	50	1	●	●	●

For an explanation on the pictos, see front flap

● = standard ○ = option

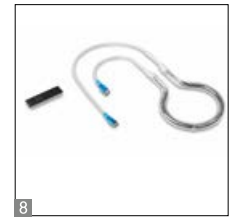

05

Particularly user-friendly moisture analyser with high-quality halogen quartz glass heater- also available as version with [d] = 10 mg, ideal for recurring rapid tests

Features

- KERN DAB 200-2: Version with lower resolution, whereby the switch-off criterion is reached faster, which saves time. Ideal for quick tests and spot checks
- Backlit Graphic display, digit height 14 mm
- 1 Drying process active
- 2 Active heating profile
- 3 Active switch-off criteria
- 4 Previous drying time
- 5 Current temperature
- 6 Current moisture content in %

- 400 W halogen-quartz glass heater
- Observation window above the sample, useful during initial setting
- Internal memory for automatic sequence of 15 complete drying processes and 5 drying processes carried out
- The last value measured remains on the display until it is replaced by a new measurement
- 50 sample plates included
- Application handbook: On the internet, you will find a practical application handbook

containing many examples, field reports, settings and tips for each KERN moisture analyser

Note: both models are also available in infra-red version, see *Accessory*

Accessories

- Sample plates aluminium, Ø 90 mm, unit of 80 pieces, KERN MLB-A01A, € 49,-
- Round fiberglass filter, medium mechanical stability, without organic binder, box of 100 pieces, KERN RH-A02, € 86,-
- Round fiberglass filter, medium mechanical stability, without organic binder, box of 100 pieces, KERN YMF-A01, € 45,-
- 7 Temperature calibration set consists of measuring sensor and display device, KERN DAB-A01, € 275,-
- 8 Infrared quartz glass heater, temperature range 40 °C-160 °C, Factory Option, KERN DAB-A02, € 198,-
- RS-232/Ethernet adapter for connection to an IP-based Ethernet network, KERN YKI-01, € 345,-
- RS-232/Bluetooth adapter to connect to Bluetooth capable devices, such as Bluetooth printers, tablets, laptops, smartphones, etc., KERN YKI-02, € 345,-
- RS-232/WiFi adapter for wireless connection to networks and WiFi capable devices, such as tablets, laptops or smartphones, KERN YKI-03, € 820,-
- 9 Display of the drying process in conjunction with BalanceConnection, for more details see the internet, Scope of supplies: 1 CD, 1 license, KERN SCD-4.0, € 189,-
- Thermal printer, KERN YKB-01N, € 355,-
- Matrix needle printer, to print the weights on normal paper, ideal for long-term archiving, KERN 911-013, € 480,-

STANDARD

CAL EXT | MEMORY | RS 232 | GLP | PRINTER | UNIT | 230 V | DMS | 1 DAY

OPTION

DAkkS | +3 DAYS

Model KERN	DAB 100-3	DAB 200-2
Readability [d]	0,001 g/0,01 %	0,01 g/0,05 %
Weighing capacity [Max]	110 g	200 g
Reproducibility weight of sample 2 g*	0,15 %	1,5 %
Reproducibility, weight of sample 10 g*	0,03 %	0,3 %
Display after drying (Display can be switched over at any time)		
Moisture [%] = Moisture content (M) from wet weight (W)	0 - 100 %	
Dry content [%] = Dry weight (D) from W	100 - 0 %	
Moisture content (M)	Absolute value in [g]	
Temperature range	40 °C-199 °C in steps up to 1 °C	
Drying modes	<input type="checkbox"/> Standard drying <input type="checkbox"/> Gentle drying <input type="checkbox"/> Rapid drying	
Switch-off criteria	• Automatic switch-off (2 mg loss in weight in 45 s) • Time controlled switch-off (3 min - 99 min 59 s, 10 s increments) • Manual switch-off at the press of a button	
Recall of measurement/ Log output	Interval can be set from 1 s - 10 min (Only when used with printer or PC)	
Overall dimensions WxDxH	240x365x180 mm	
Net weight	5,0 kg	
Price €, excl. of VAT, ex works	1290,-	1240,-
Option DAkkS Calibr. Certificate	Mass: KERN 963-127, € 93,-	
Option Factory Calibr. Certificate	Temperature: KERN 964-305, € 174,-	

* application-dependent

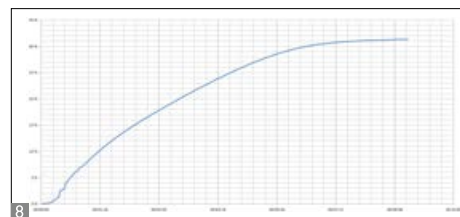

Moisture analyser with high-quality single-cell weighing system for outstanding stability, reliability and response speed

Features

- Tip: Suitable for samples with low moisture content, e.g. plastics
- Backlit Graphic display, digit height 15 mm
- 1 Drying process active
- 2 Previous drying time
- 3 Current temperature
- 4 Unit for displaying the results
- 5 Current moisture content in %
- 6 Active heating profile

- 400 W halogen-quartz glass heater
- Excellent temperature control thanks to halogen technology, suitable for temperature-sensitive samples
- Internal memory for automatic sequence of 10 complete drying processes and 100 drying processes carried out
- The last value measured remains on the display until it is replaced by a new measurement
- Password protection to prevent manipulation of stored settings, data, etc.

- Sample description for up to 99 samples, 2 digits, freely programmable, and is printed in the measuring protocol
- Date and time display as standard
- USB data interface for transferring weighing data to the PC, printer etc., *only in connection with DBS-A02
- 10 sample plates included
- Protective working cover included with delivery
- Application handbook: On the internet, you will find a practical application handbook containing many examples, field reports, settings and tips for each KERN moisture analyser

STANDARD

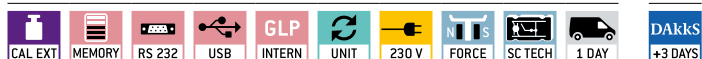

OPTION



Modell KERN	DBS 60-3
Readability [d]	0,001 g/0,01 %
Weighing capacity [Max]	60 g
Reproducibility weight of sample 2 g*	0,15 %
Reproducibility, weight of sample 10 g*	0,02 %
Display after drying	
Moisture [%] = Moisture content (M) from wet weight (W)	0-100 %
Dry content [%] = Dry weight (D) from W	100-0 %
ATRO [%] [(W-D) : D] · 100 %	0-999 %
Moisture content (M)	Absolute value in [g]
Temperature range	50 °C-200 °C in steps up to 1 °C
Drying modes	<input type="checkbox"/> Standard drying <input type="checkbox"/> Drying in levels <input type="checkbox"/> Gentle drying <input type="checkbox"/> Rapid drying
Switch-off criteria	• Automatic unrestricted switch-off (Selectable loss in weight 0,01%-0,1% in 30 s) • Time controlled switch-off (1 min - 12 h) • Manual switch-off at the press of a button
Recall of measurement/ Log output	Interval can be set from 1 s - 10 min (Only when used with printer or PC)
Overall dimensions WxDxH	204x336x167 mm
Net weight	approx. 4,6 kg
Price € , excl. of VAT, ex works	1750,-
Option DAkKS Calibr. Certificate	Mass: KERN 963-127, € 93,-
Option Factory Calibr. Certificate	Temperature: KERN 964-305, € 174,-

* application-dependent

Accessories

- Protective working cover, scope of delivery 5 items, KERN DBS-A03S05, € 44,-
- Sample plates aluminium, ø 90 mm, unit of 80 pieces, KERN MLB-A01A, € 49,-
- Round fiberglass filter, medium mechanical stability, without organic binder, box of 100 pieces, KERN RH-A02, € 86,-
- 7 Temperature calibration set consists of measuring sensor and display device, KERN DBS-A01., € 590,-
- 8 Visualisation of the drying process in connection with BalanceConnection, KERN SCD-4.0, € 189,-
- Software BalanceConnection, for flexible recording or transmission of measured values, in particular also to Microsoft® Excel or Access as well as transfer of this data to other Apps and programs, For details see the internet, Scope of supplies: 1 CD, 1 license, KERN SCD-4.0-DL, € 189,-
- USB 2.0 cable, KERN DBS-A04, € 28,-
- Thermal printer, KERN YKB-01N, € 355,-
- Matrix needle printer, to print the weights on normal paper, ideal for long-term archiving, KERN 911-013, € 480,-
- Affordable universal label printer to print out weights on thermal labels, KERN YKE-01, € 790,-



05

Moisture analyser with intuitive graphic display and step-by-step user guidance in 6 languages

Features

- Rapid and efficient operation thanks to the graphics display
 - Backlit LCD Graphic display, digit height 11 mm
 - 6 direct keys for rapid access to the main functions
- Home screen :
- 1 Main menu
 - 2 Start drying process
 - 3 Select drying temperature
 - 4 Select shut-off criteria
 - 5 Setting to zero/taring
 - 6 Stand-by

- During measurement:
- 7 Current temperature
 - 8 Current heating profile
 - 9 Active switch-off criteria
 - 10 Abort drying process
 - 11 Stop drying process
 - 12 Display current drying parameters
 - 13 Toggle the unit for displaying the results
- At the end of the measurement:
- 14 Exit drying program
 - 15 Print measurement report
 - 16 (De)activate, edit GLP parameters
 - 17 Display detailed result
 - 18 Toggle the unit for displaying the results

- 400 W halogen-quartz glass heater
- User guidance in 6 languages: DE, EN, FR, IT, ES, PT
- Automatic taring when starting a measurement by closing the lid
- The last value measured remains on the display until it is replaced by a new measurement
- 19 Internal GLP; printout of balance ID, project ID, user ID, values determined by the drying process etc.
- 10 sample plates included
- Protective working cover included with delivery
- Application handbook: On the internet, you will find a practical application handbook containing many examples, field reports, settings and tips for each KERN moisture analyseris for each KERN moisture analyser

STANDARD						OPTION	

Modell KERN	DLB 160-3A
Readability [d]	0,001 g/0,01 %
Weighing capacity [Max]	160 g
Reproducibility weight of sample 2 g*	0,15 %
Reproducibility, weight of sample 10 g*	0,05 %
Display after drying (Display can be switched over at any time)	
Moisture [%] = Moisture content (M) from wet weight (W)	0-100 %
Dry content [%] = Dry weight (D) from W	100-0 %
ATRO [%] [(W-D) : D] · 100 %	0-999 %
Moisture content (M)	Absolute value in [g]
Temperature range	35 °C-160 °C in steps up to 1 °C
Drying modes	<input type="checkbox"/> Standard drying <input checked="" type="checkbox"/> Rapid drying, preheating can be switched on
Switch-off criteria	<ul style="list-style-type: none"> • Automatic unrestricted switch-off (Selectable loss in weight 1 mg/30 s-10 mg/30 s) • Time controlled switch-off (1 min - 99 min) • Manual switch-off at the press of a button
Log output	• Interval adjustable (5 s - 250 s)
Overall dimensions WxDxH	215x345x235 mm
Net weight	approx. 4,7 kg
Price €, excl. of VAT, ex works	1655,-
Option DAkkS Calibr. Certificate	Mass: KERN 963-127, € 93,-
Option Factory Calibr. Certificate	Temperature: KERN 964-305, € 174,-

* application-dependent

Accessories

- Protective working cover, scope of delivery: 5 items, KERN ALJ-A01S05, € 44,-
- Sample plates aluminium, ø 90 mm, unit of 80 pieces, KERN MLB-A01A, € 49,-
- Round fiberglass filter high mechanical stability, with organic binder, box of 100 pieces, KERN RH-A02, € 86,-
- Round fiberglass filter medium mechanical stability, without organic binder, box of 100 pieces, KERN YMF-A01, € 45,-
- Temperature calibration set consists of measuring sensor and display device, KERN DLB-A01N., € 590,-
- Thermal printer, KERN YKB-01N, € 355,-
- Matrix needle printer, to print the weights on normal paper, ideal for long-term archiving, KERN 911-013, € 480,-



06 BENCH SCALES

Compact industrial weighing technology

Thanks to their compact dimensions, low weight, robust internal mechanism and the fact that they can be operated independent of mains power, bench scales can be used not only in a stationary situation, but also as mobile scales.

With weighing ranges between 3 kg and 65 kg, bench scales can cover a wide range of applications. Whether as a commissioning scale in the warehouse, for inventory purposes, on a production work station, in quality control, in small workshops, in service cars or in sales offices, bench scales are the first choice.









Durable stainless steel weighing plates, easy to read backlit displays, useful functions such as piece counting, PRE-TARE – subtraction of a known container weight, or ► **interfaces** to PC and printer, all these support the users in their daily work.

► **Multi-division balances and Multi-range balances** cover a particularly wide range of applications. With these scales, the total weighing range is divided into subranges and begins with a high resolution read-out in the fine weighing range. If this range is exceeded the balance automatically switches to the higher weighing range with the lower resolution read-out.

All KERN bench scales have an adjustment program (CAL) to adjust the accuracy. This way, the high level of accuracy is guaranteed at all times, even during harsh everyday use. Find the right test weights for you, on page 182.

► **See the glossary on page 223–225**

Quick-Finder Bench scales

Readability [d] g	Weighing capacity [Max] kg	Weighing plate WxD mm	Model KERN	Price excl. of VAT ex works €	Page									
0,02	6	340x240	FKB 6K0.02	510,-	58	1	●	○	●	●	●	●	●	○
0,05	6	294x225	GAB 6K0.05N	405,-	60	1	●	○	●	●	●	●	●	○
0,05	8	340x240	FKB 8K0.05	480,-	58	1	●	○	●	●	●	●	●	○
0,05	16	340x240	FKB 16K0.05	550,-	58	1	●	○	●	●	●	●	●	○
0,1	3	253x228	FCB 3K0.1	270,-	57	1	●	○	●	●	●	●	●	○
0,1	8	253x228	FCB 8K0.1	290,-	57	1	●	○	●	●	●	●	●	○
0,1	8	340x240	FKB 8K0.1	390,-	58	1	●	○	●	●	●	●	●	○
0,1	12	294x225	GAB 12K0.1N	405,-	60	1	●	○	●	●	●	●	●	○
0,1	16	340x240	FKB 16K0.1	485,-	58	1	●	○	●	●	●	●	●	○
0,1	36	340x240	FKB 36K0.1	540,-	58	1	●	○	●	●	●	●	●	○
0,2	30	294x225	GAB 30K0.2N	405,-	60	1	●	○	●	●	●	●	●	○
0,2	36	340x240	FKB 36K0.2	520,-	58	1	●	○	●	●	●	●	●	○
0,2	65	340x240	FKB 65K0.2	560,-	58	1	●	○	●	●	●	●	●	○
0,5	6	253x228	FCB 6K0.5	250,-	57	1	●	○	●	●	●	●	●	○
0,5	15	340x240	FKB 15K0.5	385,-	58	1	●	○	●	●	●	●	●	○
1	3	253x228	FCE 3K1N	145,-	56	1	●	○	●	●	●	●	●	○
1	12	253x228	FCB 12K1	230,-	57	1	●	○	●	●	●	●	●	○
1	30	253x228	FCB 30K1	275,-	57	1	●	○	●	●	●	●	●	○
1	30	340x240	FKB 30K1	390,-	58	1	●	○	●	●	●	●	●	○
1	65	340x240	FKB 65K1	390,-	58	1	●	○	●	●	●	●	●	○
1 2	3 6	295x225	GAB 6K1DNM	310,-	60	1	○	●	○	●	●	●	●	○
2	6	253x228	FCE 6K2N	145,-	56	1	●	○	●	●	●	●	●	○
2	24	253x228	FCB 24K2	225,-	57	1	●	○	●	●	●	●	●	○
2 5	6 15	300x230	GAB 15K2DNM	310,-	60	1	○	●	○	●	●	●	●	○
5	10	320x260	ECE 10K-3N	125,-	55	1	●	○	●	●	●	●	●	○
5	10	320x260	ECB 10K-3N	145,-	55	1	●	○	●	●	●	●	●	○
5	15	253x228	FCE 15K5N	145,-	56	1	●	○	●	●	●	●	●	○
5 10	15 30	294x225	GAB 30K5DNM	310,-	60	1	○	●	○	●	●	●	●	○
10	20	320x260	ECE 20K-2N	125,-	55	1	●	○	●	●	●	●	●	○
10	20	320x260	ECB 20K-2N	145,-	55	1	●	○	●	●	●	●	●	○
10	30	253x228	FCE 30K10N	145,-	56	1	●	○	●	●	●	●	●	○
20	50	320x260	ECE 50K-2N	125,-	55	1	●	○	●	●	●	●	●	○
20	50	320x260	ECB 50K-2N	145,-	55	1	●	○	●	●	●	●	●	○

● = standard ○ = option

06



Plain, mobile, uncomplicated

Features

- **2** High mobility: thanks to battery operation/rechargeable battery operation (optional), compact, lightweight construction, it is suitable for the use in several locations (production, warehouse, dispatch department etc.)
- Particularly large weighing plate
- Very fast display: steady weight values within 2 s
- Simple and convenient 2-key operation

Technical data

- ECE-N: Large LCD display, digit height 21 mm
- ECB-N: Large backlit LCD display, digit height 21 mm
- Weighing plate material
 - ECE-N: plastic
 - ECB-N: stainless steel, see larger picture
- Dimensions weighing surface, W×D
320×260 mm
- Overall dimensions W×D×H
320×300×60 mm
- Battery operation, 6×1.5 V AA standard, operating time up to 100 h, AUTO-OFF function to preserve the battery
- Net weight
 - ECE-N: approx. 1,6 kg
 - ECB-N: approx. 2,6 kg
- Permissible ambient temperature
5 °C/35 °C

Accessories

- Internal rechargeable battery pack, operating time up to 30 h without backlight, charging time approx. 10 h, KERN PCB-A01, **€ 90,-**
- Rechargeable battery pack external, operating time up to 30 h without backlight, charging time approx. 10 h, KERN KS-A01, **€ 180,-**
- Tare pan made from stainless steel, overall dimensions W×D×H, 400×300×45 mm, KERN RFS-A02, **€ 75,-**
- External universal mains adapter, with universal input and optional input socket adapters for EU, CH, GB, USA, KERN YKA-03N, **€ 38,-**
- Further details, plenty of further accessories and suitable printers see *Accessories*

STANDARD				OPTION		

Model	Weighing capacity [Max] kg	Readability [d] g	Reproducibility g	Linearity g	Price excl. of VAT ex works €	Option DAkkS Calibr. Certificate	
						DAkkS KERN	€
KERN							
ECE 10K-3N	10	5	5	± 20	125,-	963-128	112,-
ECE 20K-2N	20	10	10	± 40	125,-	963-128	112,-
ECE 50K-2N	50	20	20	± 80	125,-	963-128	112,-
ECB 10K-3N	10	5	5	± 20	145,-	963-128	112,-
ECB 20K-2N	20	10	10	± 40	145,-	963-128	112,-
ECB 50K-2N	50	20	20	± 80	145,-	963-128	112,-

06



Entry-level bench scale – mobile, practical, lightweight

Features

- Simple and convenient 2-key operation
- Very fast display: steady weight values within 3 s
- **1** Ideal as a compact letter and parcel scale, especially where space is limited
- **2** Ideal as a grading, commissioning or simple checkweighing scale in production or dispatch
- Protective working cover included with delivery

Technical data

- Large LCD display, digit height 25 mm
- Dimensions weighing surface, plastic, WxD 253x228 mm
- Overall dimensions WxDxH 270x323x110 mm
- Optional battery operation, 9 V block not included in scope of delivery, operating time up to 12 h, AUTO-OFF function to preserve the battery
- Net weight approx. 2,4 kg
- Permissible ambient temperature 5 °C/35 °C

Accessories

- Protective working cover, scope of delivery 5 pieces, KERN FCB-A02S05, **€ 85,-**
- **3** Stainless steel weighing plate, robust, removable, for easy cleaning, KERN FCE-A01, **€ 40,-**
- Internal rechargeable battery pack, operating time up to 20 h without backlight, charging time approx. 10 h, KERN FCB-A01, **€ 54,-**

STANDARD					OPTION	
CAL EXT	BATT	MULTI	DMS	1 DAY	ACCU	DAKKS +3 DAYS

Model	Weighing capacity [Max] kg	Readability [d] g	Reproducibility g	Linearity g	Price excl. of VAT ex works €	Option	
						DAKKS KERN	DAKKS Calibr. Certificate €
FCE 3K1N	3	1	2	± 3	145,-	963-127	93,-
FCE 6K2N	6	2	2	± 4	145,-	963-128	112,-
FCE 15K5N	15	5	10	± 15	145,-	963-128	112,-
FCE 30K10N	30	10	10	± 30	145,-	963-128	112,-



Bench scale, also with second display on the backside of the scale

<p>Features</p> <ul style="list-style-type: none"> • PRE-TARE function for manual subtraction of a known container weight, useful for checking fill-levels • High mobility: thanks to battery operation/rechargeable battery operation (optional), compact, lightweight construction, it is suitable for the use in several locations (production, warehouse, dispatch department etc.) • Data interface RS-232 as standard • Protective working cover included with delivery 	<p>Technical data</p> <ul style="list-style-type: none"> • Backlit LCD display, digit height 25 mm • Dimensions weighing surface, stainless steel, W×D 253×228 mm • Overall dimensions W×D×H 270×323×110 mm • Optional battery operation, 9 V block not included in scope of delivery, operating time up to 12 h • Net weight approx. 2,6 kg • Permissible ambient temperature 5 °C/35 °C 	<p>Accessories</p> <ul style="list-style-type: none"> • Protective working cover, scope of delivery 5 items, KERN FCB-A01S05, € 44,- • Internal rechargeable battery pack, operating time up to 10 h without backlight, charging time approx. 10 h, KERN FCB-A01, € 54,- • Further details, plenty of further accessories and suitable printers see <i>Accessories</i>
--	--	--

STANDARD										OPTION				

Model	Weighing capacity [Max] kg	Readability [d] g	Reproducibility g	Linearity g	Smallest part weight [Normal] g/piece	Price excl. of VAT ex works €	Option	
							DAkks KERN	Calibr. Certificate €
KERN FCB 3K0.1	3	0,1	0,1	± 0,3	2	270,-	963-127	93,-
FCB 6K0.5	6	0,5	0,5	± 1,5	10	250,-	963-128	112,-
FCB 8K0.1	8	0,1	0,1	± 0,3	2	290,-	963-128	112,-
FCB 12K1	12	1	1	± 3	20	230,-	963-128	112,-
FCB 24K2	24	2	2	± 6	40	225,-	963-128	112,-
FCB 30K1	30	1	1	± 3	20	275,-	963-128	112,-

FACE
LIFTPREMIUM
★★★

High resolution bench scale with large weighing range and robust stainless steel weighing plate

Features

- Thanks to the high resolution of up to 360.000 points it is ideal for high-precision weighing in the industrial field
- Robust plastic die-cast housing: maintains the stability, protects the weighing technology elements and is robust enough to cope with everyday use
- PRE-TARE function for manual subtraction of a known container weight, useful for checking fill-levels
- Industry 4.0: The integrated KERN Universal Port (KUP) allows the connection of external KUP interface adapters such as RS-232, USB,

Bluetooth, WLAN, Analogue, Ethernet etc. The outstanding advantage here is that the KUP interface adapters are simply plugged in, i.e. retrofitting interfaces is conveniently possible without opening the scale housing or complicated installation. The interface adapters enable convenient transmission of weighing data to networks, PCs, smartphones, tablets, laptops, printers etc. In addition, control commands and data inputs can also be sent to the scale via the connected devices.
Tip: with the KERN YKUP-13 extension box, up to three KUP interface adapters can be operated in parallel on the scale

- KERN Communication Protocol (KCP): The KCP permits searching and remote control of the balance using external control devices or computers. for details see page 8/9
- Freely programmable weighing unit, e.g. display direct in special units such as length of wire g/m, surface weight g/m², or else
- Level indicator and levelling feet for precise levelling of the scale, fitted as standard
- Protective working cover included with delivery



Technical data

- Large backlit LCD display, digit height 25 mm
- Dimensions weighing surface, stainless steel, WxD 340×240 mm
- Overall dimensions W×D×H 350×390×120 mm
- Optional battery operation, 4×1.5 V AA not included in scope of delivery, operating time up to 20 h
- Net weight approx. 7 kg
- Permissible ambient temperature -10 °C/40 °C

Accessories

- Protective working cover, scope of delivery 5 items, KERN FKB-A02S05, **€ 44,-**
- Internal rechargeable battery pack, operating time up to 48 h without backlight, charging time approx. 8 h, KERN YKR-01, **€ 35,-**
- External data interface USB, Interface cable included, KERN YKUP-03, **€ 98,-**
- External data interface RS-232, Interface cable included, KERN YKUP-01, **€ 68,-**
- Bluetooth interface adapter, KERN YKUP-06, **€ 98,-**
- WiFi interface adapter, KERN YKUP-05, **€ 98,-**
- External data interface Ethernet, KERN YKUP-04, **€ 125,-**
- Extension-Box, KERN YKUP-13, **€ 98,-**
- Tare pan made from stainless steel, overall dimensions W×D×H, 400×300×45 mm, KERN RFS-A02, **€ 75,-**
- Further details, plenty of further accessories and suitable printers see *Accessories*

Particularly practical: thanks to the large weighing ranges and compact dimensions, you can accurately weigh heavy loads in the most restricted of spaces. Useful for determining very small weight differences, such as, for example, gas wastage, abrasion of mechanical parts, rock samples, minerals, druses, silver etc.

STANDARD



OPTION

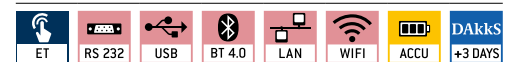

Model	Weighing capacity [Max] kg	Readability [d] g	Reproducibility g	Linearity g	Smallest part weight [Normal] g/piece	Resolution Points	Price excl. of VAT ex works €	Option DAKKS Calibr. Certificate DAKKS KERN	€
KERN FKB 6K0.02	6	0,02	0,04	± 0,2	0,2	300.000	510,-	963-128	112,-
KERN FKB 8K0.05	8	0,05	0,05	± 0,5	0,5	300.000	480,-	963-128	112,-
KERN FKB 8K0.1	8	0,1	0,05	± 0,5	0,5	160.000	390,-	963-128	112,-
KERN FKB 15K0.5	15	0,5	0,1	± 0,3	10	320.000	385,-	963-128	112,-
KERN FKB 16K0.05	16	0,05	0,1	± 1	0,5	80.000	550,-	963-128	112,-
KERN FKB 16K0.1	16	0,1	0,1	± 1	1	160.000	485,-	963-128	112,-
KERN FKB 30K1	30	1	0,2	± 2	20	360.000	390,-	963-128	112,-
KERN FKB 36K0.1	36	0,1	0,2	± 2	1	180.000	540,-	963-128	112,-
KERN FKB 36K0.2	36	0,2	0,5	± 5	2	325.000	520,-	963-128	112,-
KERN FKB 65K0.2	65	0,2	1	± 10	2	30.000	560,-	963-129	139,-
KERN FKB 65K1	65	1	1	± 10	20	65.000	390,-	963-129	139,-



06

Checkweighing and portioning scale, also with EC type approval [M]

Features

- Compact size, practical for small spaces
- High mobility: thanks to rechargeable battery operation (optional), compact, lightweight construction, it is suitable for the use in several locations (production, warehouse, dispatch department etc.)
- Weighing with tolerance range (checkweighing): a visual and audible signal helps with portioning, dispensing or grading
- Totalising of weights
- Protective working cover included with delivery

Technical data

- Large backlit LCD display, digit height 24 mm
- Dimensions weighing surface WxD 295x225 mm
- Overall dimensions WxDxH 315x350x125 mm
- Net weight approx. 3,0 kg
- Permissible ambient temperature
GAB-N: 0 °C/40 °C
GAB-DNM: -10 °C/40 °C

Accessories

- Protective working cover, scope of delivery 5 items, KERN CFS-A02S05, € 44,-
- Internal rechargeable battery pack, operating time up to 90 h without backlight, charging time approx. 12 h, KERN GAB-A04, € 42,-
- 1 Signal lamp for visual support of weighing with tolerance range, KERN CFS-A03, € 330,-
- 2 Y-cable for parallel connection of two terminal devices to the RS-232 interface on the scale, e.g. signal lamp and printer, KERN CFS-A04, € 38,-
- Tare pan made from stainless steel, overall dimensions WxDxH, 400x300x45 mm, KERN RFS-A02, € 75,-
- Further details, plenty of further accessories and suitable printers see *Accessories*

Application examples

- Small industrial scale for pharmacies
- Hand mixtures of tea, coffee, chocolates
- Portioning of dough, meat, fish, poultry, mixed salads in cafeterias etc.
- Mobile weighing of freshly picked fruit on site
- Checkweigher in supermarkets
- High-precision industrial applications, piece counting or stock-taking

Note: Official verification is mandatory for commercial trade.

STANDARD										OPTION			FACTORY	
													GAB-DNM	

Model	Weighing capacity [Max] kg	Readability [d] g	Verification value [e] g	Minimal load [Min] g	Smallest part weight [Normal] g/piece	Price excl. of VAT ex works €	Option			
							Verification KERN	€	DAkkS Calibr. Certificate DAKkS KERN	€
GAB 6K0.05N	6	0,05	-	-	0,5	405,-	-	-	963-128	112,-
GAB 12K0.1N	12	0,1	-	-	1	405,-	-	-	963-128	112,-
GAB 30K0.2N	30	0,2	-	-	2	405,-	-	-	963-128	112,-

Multi-division balance, with increasing or decreasing load, it switches automatically to the next largest or smallest weighing range [Max] and readout [d].

Note: For applications that require verification, please order verification at the same time, initial verification at a later date is not possible.

Verification at the factory, we need to know the full address of the location of use.

GAB 6K1DNM	3 6	1 2	1 2	20	2	310,-	965-228	80,-	963-128	112,-
GAB 15K2DNM	6 15	2 5	2 5	40	5	310,-	965-228	80,-	963-128	112,-
GAB 30K5DNM	15 30	5 10	5 10	100	10	310,-	965-228	80,-	963-128	112,-

FOOD



(KITCHEN/STAINLESS STEEL/IP65...68 PROTECTION)

KERN scales – without fear of water!

Scales used in industrial situations or the food industry are often exposed to extreme stresses and strains. Water, oils, fats, varnish, dust, dirt, flour, small parts etc. are all natural enemies of a scale. In industries such as the food, chemical, manufacturing industries, etc., scales must be able to cope with these stresses without this affecting their performance.

For use in such harsh environmental conditions, levels of protection are defined, which specify which environmental stresses a system can be exposed to with respect to the level of contact, foreign object and moisture protection, without damage being caused to the unit. These levels of protection are described in the following standard: “DIN EN 60529: protection types through housing” The IP code usually consists of a two-digit combination, which gives the relevant level of protection, e.g. IP68.

The first digit specifies the protection level for contact protection and protection against foreign bodies (dust protection), the second digit is for the water and moisture protection (protection against splashes of water).

All stainless steel components of the IP65...68 protected KERN stainless steel scales are made of corrosion-resistant steel of quality class 1.4301 (DIN X5CrNi18-10). The material properties support you in your ► **HACCP**-compliant quality system.

► See the glossary on page 223–225

Extract from the standard: “DIN EN 60529: protection types through housing”:

KERN-Pictogram	1. digit	Specification	2. digit	Specification
	6	Dustproof	5	Protection against jets of water (nozzle) from any angle (cleaning with a damp cloth)
	6	Dustproof	6	Protection against powerful jets of water
	6	Dustproof	7	Protection against temporary immersion
	6	Dustproof	8	Protection against continuous immersion (designed for continuous use in wet areas, submersion is possible depending on the pressure (water depth))



1 FGE 5K-3S05

2 FGE 10K-3S05

Precise design kitchen scale for kitchen, cafeteria, gastronomy

The price breaker!

Most economical kitchen scale in the KERN assortment

from €

22,-**

** Price/unit, excl. of VAT ex works, only available in a set of 5 units

07

Features

- FGE 10K-3S05: Weighing plate made out of safety glass
- Easy and hygienic cleaning
- Low overall height for secure footing and space-saving storage
- Secure and non-slip positioning with rubber feet
- Very easy to use
FGE 5K-3S05: 2 Buttons
FGE 10K-3S05: 1 Button
- Comfortable taring with just one keystroke. For example, you can tare a bowl before starting a formulation. In addition, you can tare each time you weigh in a formulation ingredient, so that you can weigh in the next formulation ingredient with the weight indicated in the formula without having to do any calculations
- Integrated AUTO-OFF function to preserve the batteries
- Large high-contrasted display that is easy to read
- 3 Delivered in single design packaging

Technical data

- 1 FGE 5K-3S05**
- Large backlit LCD display, Digit height 18 mm
 - Overall dimensions W×D×H 152×230×15 mm
 - Dimensions of glass weighing plate, W×D 152×230 mm
 - Ready for use: Batteries included, 2×CR2032
- 2 FGE 10K-3S05**
- Large, luminescent LED display, Digit height 22 mm
 - Overall dimensions W×D×H 272×250×22 mm
 - Dimensions of glass weighing plate, W×D 272×205 mm
 - Ready for use: Batteries included, 3×1.5 V AAA
- Note:** The models with the suffix -S05 are delivered in a set of 5 units. i.e. the price given in the table refers to 5 items. Cannot be delivered individually. The calibration prices refers to one single balance

STANDARD OPTION

CAL EXT
 UNIT
 BATT
 DMS
 1 DAY
 DAkKS +3 DAYS

Model	Weighing capacity	Readability	Price		Option
			excl. of VAT ex works	DAkKS	DAkKS Calibr. Certificate
	[Max] kg	[d] g	€	KERN	€
FGE 5K-3S05	5	1	130,-*	963-127	93,-
FGE 10K-3S05	15	1	175,-*	963-128	112,-

* Price set of 5 units



07 Compact bench scale with multi-purpose functionality and a high level of accuracy for use in industry, gastronomy and kitchen

Features

- Simple and convenient 5-key operation
- Very fast display: steady weight values within 3 s
- Ideal as a
 - Checkweigher in the catering trade, cafeterias, school kitchens
 - compact letter and parcel scale, especially in constricted spaces
 - grading or commissioning balance or simple checkweigher in production or dispatch
- High mobility: thanks to battery operation/ rechargeable battery operation (optional), compact, lightweight construction, it is suitable for the use in several locations (production, warehouse, dispatch department etc.)
- Protective working cover included with delivery

Technical data

- Large backlit LCD display, digit height 25 mm
- Dimensions weighing surface, stainless steel, WxD 253x228 mm
- Overall dimensions WxDxH 270x345x106 mm
- Optional battery operation, 9 V block not included in scope of delivery, operating time up to 20 h, AUTO-OFF function to preserve the battery
- Net weight approx. 2,8 kg
- Permissible ambient temperature 5 °C/35 °C

Accessories

- Protective working cover, scope of delivery 5 items, KERN FCF-A01S05, **€ 44,-**
- Internal rechargeable battery pack, operating time up to 120 h without backlight, charging time approx. 16 h, KERN GAB-A04, **€ 42,-**

STANDARD

CAL EXT PCS RECIPE PERCENT UNIT MOVE BATT MULTI DMS 1 DAY

OPTION

ACCU DAKKS +3 DAYS

Model	Weighing capacity [Max] kg	Readability [d] g	Reproducibility g	Linearity g	Smallest part weight [Normal] g/piece	Price excl. of VAT ex works €	Option DAkKS Calibr. Certificate DAkKS KERN €
KERN FCF 3K-4	3	0,1	0,1	± 0,3	2	250,-	963-127 93,-
KERN FCF 30K-3	30	1	1	± 3	20	250,-	963-128 112,-



Compact stainless steel bench scale with EC type approval [M] and special checkweighing display for even more efficient working

07

Features

- **1** Innovative weighing with tolerance range (Checkweighing): The colour of the display changes depending on the weight (too light/ok/too heavy) and is an aid to help with portioning, dosing and grading
- Thanks to the stainless steel design of the housing and platform with smooth surface, the scale is rust-free and easy to clean
- **2** Ideal for the increased hygienic requirements in the food industries
- High mobility: thanks to battery operation, compact, lightweight construction, it is suitable for the use in several locations (kitchens, sales offices, cafeterias, food industry laboratories, etc.)
- Your support in a HACCP-compliant quality system
- Protection against dust and water splashes IP65 (only when using battery)

- Secure and non-slip positioning with rubber feet
- Increased protection against humidity through waterproof silicone sealing of the load cell, electronics and soldering joints
- Mains adapter included with the delivery
- Protective working cover included with delivery

Technical data

- Large backlit LCD display, digit height 25 mm
- Dimensions weighing surface, stainless steel, WxD 248x198 mm
- Overall dimensions WxDxH 256x285x100 mm
- Battery operation, 4x1.5 V AA standard, operating time up to 48 h, AUTO-OFF function to preserve the battery
- Net weight approx. 3,8 kg
- Permissible ambient temperature 0 °C/40 °C

Accessories

- **3** Protective working cover, scope of delivery 5 items, KERN FOB-A13S05, € 44,-
- **4** Tare pan made from stainless steel, overall dimensions WxDxH, 400x300x45 mm, KERN RFS-A02, € 75,-

Note: Official verification is mandatory for commercial trade



Model	Weighing capacity [Max] kg	Readability [d] g	Verification value [e] g	Minimal load [Min] g	Weighing plate mm	Price excl. of VAT ex works €	Option			
							Verification M KERN €	DAKKS €	Calibr. DAKKS KERN €	Certificate €
FOB 1K-4LM	1,5	0,5	0,5	10	248x198	335,-	965-227	62,-	963-127	93,-
FOB 3K-3LM	3	1	1	20	248x198	340,-	965-227	62,-	963-127	93,-
FOB 6K-3LM	6	2	2	40	248x198	335,-	965-228	80,-	963-128	112,-
FOB 10K-3LM	15	5	5	100	248x198	335,-	965-228	80,-	963-128	112,-

Note: For applications that require verification, please order verification at the same time, initial verification at a later date is not possible. Verification at the factory, we need to know the full address of the location of use.



FOB-S



FOB-NS

07 Super compact stainless steel balance for weighing, checking and portioning in the smallest of spaces

Features

- Thanks to the stainless steel design of the housing and platform with smooth surface, the scale is rust-free and easy to clean
- High mobility: thanks to battery operation, compact, lightweight construction, it is suitable for the use in several locations (kitchen, sales office, cafeteria, food industry-laboratory etc.)
- Secure and non-slip positioning with rubber feet
- Your support in a HACCP-compliant quality system
- Particularly flat design
- Protective working cover included with delivery
- KERN FOB-NS: Protection against dust and water splashes IP65 (only when using battery)

Accessories

- Protective working cover, scope of delivery 5 items, KERN FOB-S: KERN FOB-A11S05, € 44,-
KERN FOB-NS: KERN FOB-A12S05, € 44,-
- External mains adapter, KERN FOB-A09, € 44,-

STANDARD						OPTION	
FOB-NS							

Model KERN	FOB 500-1S	FOB 5K1S	FOB 0.5K-4NS	FOB 5K-3NS
Weighing capacity [Max] kg	0,5	5	0,5	5
Readability [d] g	0,1	1	0,1	1
LCD display, digit height mm	20 without backlight			
Dimens. weighing surface mm	155×125		150×120	
Overall dimensions mm	155×175×40		150×170×40	
Power supply	9 V block, operating time up to 20 h			
Net weight kg	0,7		0,8	
Permissible ambient temperature	10 °C/40 °C		10 °C/35 °C	10 °C/40 °C
Price, excl. of VAT ex works, €	95,-		125,-	
Option DAkkS Calibr. Certificate	963-127, € 93,-			



FOB



FOB-NL

Stainless steel bench scale with large weighing ranges and IP67 protection against dust and water spray

07

Features

- High mobility: thanks to battery operation, compact, lightweight construction, it is suitable for the use in several locations (kitchen, sales office, cafeteria, Food industry-Laboratory etc.)
- Thanks to the stainless steel design of the housing and platform with smooth surface, the scale is rust-free and easy to clean
- Ideal for the increased hygienic requirements in the food industries
- Your support in a HACCP-compliant quality system
- Increased protection against humidity through waterproof silicone sealing of the load cell, electronics and soldering joints

- KERN FOB-NL: Protection against dust and water splashes IP67 (only when using battery)
- KERN FOB: Innovative weighing with tolerance range (Checkweighing): The colour of the display changes depending on the weight (too light/ok/too heavy) and is an aid to help with portioning, dosing and grading
- Protective working cover included with delivery

Accessories

- Protective working cover, scope of delivery 5 items
KERN FOB: KERN FOB-A05S05, € 44,-
KERN FOB-NL: KERN FOB-A13S05, € 44,-
- KERN FOB: Internal rechargeable battery pack, operating time up to 24 h without backlight, charging time approx. 8 h, KERN FOB-A07, € 60,-
- KERN FOB-NL: External mains adapter, KERN YKA-29, € 43,-
- Tare pan made from stainless steel, overall dimensions W×D×H, 400×300×45 mm, KERN RFS-A02, € 75,-

STANDARD

CAL EXT TOL 230 V DMS 1 DAY

OPTION

ACCU DAKkS +3 DAYS

STANDARD

CAL EXT UNIT IP 67 BATT DMS 1 DAY

OPTION

230 V DAKkS +3 DAYS

Model KERN	FOB 1.5K0.5	FOB 3K1	FOB 6K2	FOB 3K-4NL	FOB 7K-4NL*	FOB 10K-3NL*	FOB 30K-3NL*
Weighing capacity [Max] kg	1,5	3	6	3	5 7,5	8 15	16 30
Readability [d] g	0,5	1	2	0,2	0,5 1	1 2	2 5
LCD display, digit height mm	20 without backlight			25 without backlight		25 backlight	
Dimens. weighing surface mm	175×165			248×198		252×200	
Overall dimensions mm	235×175×55			295×260×95		285×255×90	
Power supply	Plug-in power supply			Batteries included, 4×1.5 V AA, operating time up to 48 h			
Net weight kg	2,0			3,8			
Permissible ambient temperature	5 °C/35 °C			5 °C/35 °C			
Price, excl. of VAT ex works, €	240,-	240,-	240,-	330,-	295,-	295,-	295,-
Option DAkkS Calibr. Certificate	963-127, € 93,-	963-128, € 112,-		963-127, € 93,-		963-128, € 112,-	

*Multi-division balance, with increasing or decreasing load, it switches automatically to the next largest or smallest weighing range [Max] and readout [d].



07 Ideal for food industry, thanks to its IP65 protection and special checkweighing display, now also with EC type approval [M]

Features

- Ideal for the increased hygienic requirements in the food industries
- Your support in a HACCP-compliant quality system
- **1** Protection against dust and water splashes IP65 (only when using rechargeable battery pack)
- Very fast display: steady weight values within 2 s
- **2** Second display on the back of the balance
- Compact size, practical for small spaces
- **3** Innovative weighing with tolerance range (Checkweighing): The colour of the display changes depending on the weight (too light/ok/too heavy) and is an aid to help with portioning, dosing and grading
- High mobility: thanks to rechargeable battery operation (optional), compact,

- lightweight construction, it is suitable for the use in several locations
- Recessed grips on the underside of the scale for easy transportation
- Protective working cover included with delivery

Technical data

- Large backlit LCD display, digit height 25 mm
- Dimensions weighing surface, stainless steel, WxD 263x203 mm
- Overall dimensions WxDxH 286x316x126,5 mm
- Net weight approx. 3,2 kg
- Permissible ambient temperature -10 °C/40 °C

Accessories

- Protective working cover, scope of delivery 5 items, KERN RFB-A01S05, **€ 44,-**
- Internal rechargeable battery pack, operating time up to 50 h without backlight, charging time approx. 12 h, KERN WTB-A01N, **€ 38,-**
- **4** Tare pan made from stainless steel, overall dimensions WxDxH, 400x300x45 mm, KERN RFS-A02, **€ 75,-**

STANDARD OPTION FACTORY

Model	Weighing capacity [Max] kg	Readability [d] g	Verification value [e] g	Minimal load [Min] g	Price excl. of VAT ex works €	Option		
						Verification KERN	DAkkS KERN	Calibr. Certificate KERN
KERN						€	€	€
WTB 1K-4N	1,5	0,2	-	-	305,-	-	-	963-127 93,-
WTB 3K-4N	3	0,5	-	-	305,-	-	-	963-127 93,-
WTB 6K-3N	6	1	-	-	305,-	-	-	963-128 112,-
WTB 10K-3N	15	2	-	-	305,-	-	-	963-128 112,-
WTB 30K-3N	30	5	-	-	305,-	-	-	963-128 112,-

Note: For applications that require verification, please order verification at the same time, initial verification at a later date is not possible. Verification at the factory, we need to know the full address of the location of use.

WTB 1K-4NM	1,5	0,5	0,5	10	325,-	965-227	62,-	963-127	93,-
WTB 3K-3NM	3	1	1	20	325,-	965-227	62,-	963-127	93,-
WTB 6K-3NM	6	2	2	40	325,-	965-228	80,-	963-128	112,-
WTB 10K-3NM	15	5	5	100	325,-	965-228	80,-	963-128	112,-
WTB 30K-2NM	30	10	10	200	325,-	965-228	80,-	963-128	112,-



All-round bench scale, protected by stainless steel and IP65 rating, also with EC type approval [M]

Features

- **1** Ideal for the ever-increasing hygienic requirements in the food, pharmaceutical and chemical industries
- Your support in a HACCP-compliant quality system
- **2** Ideal for the robust industrial applications
- **3** Protection against dust and water splashes IP65 (only when using rechargeable battery pack)
- High mobility: thanks to rechargeable battery operation, compact, lightweight construction, it is suitable for the use in several locations (kitchen, sales office, cafeteria, Food industry-Laboratory etc.)
- Thanks to the stainless steel design of the housing and platform with smooth surface, the scale is rust-free and easy to clean
- Recessed grips on the underside of the scale for easy transportation

Technical data

- Large backlit LCD display, digit height 25 mm
- Dimensions weighing surface, stainless steel, WxD 233x193 mm
- Overall dimensions WxDxH 243x300x127 mm
- Rechargeable battery pack integrated, as standard, operating time up to 50 h without backlight, charging time approx. 12 h
- Net weight approx. 4,0 kg
- Permissible ambient temperature -10 °C/40 °C

Accessories

- Tare pan made from stainless steel, overall dimensions WxDxH, 400x300x45 mm, KERN RFS-A02, € 75,-

STANDARD

CAL EXT UNIT IP 65 ACCU MULTI DMS 1 DAY

OPTION FACTORY

DAkkS +3 DAYS M +3 DAYS FFN-M

Model	Weighing capacity [Max] kg	Readability [d] g	Verification value [e] g	Minimal load [Min] g	Price excl. of VAT ex works €	Verification KERN €	Option DAkkS Calibr. Certificate DAKKS KERN €
KERN FFN 1K-4N	1,5	0,2	-	-	350,-	-	963-127 93,-
FFN 3K0.5IPN	3	0,5	-	-	350,-	-	963-127 93,-
FFN 6K1IPN	6	1	-	-	350,-	-	963-128 112,-
FFN 15K2IPN	15	2	-	-	350,-	-	963-128 112,-
FFN 25K5IPN	25	5	-	-	350,-	-	963-128 112,-

Note: For applications that require verification, please order verification at the same time, initial verification at a later date is not possible. Verification at the factory, we need to know the full address of the location of use.

FFN 1K-4NM	1,5	0,5	0,5	10	370,-	965-227 62,-	963-127 93,-
FFN 3K1IPM	3	1	1	20	370,-	965-227 62,-	963-127 93,-
FFN 6K2IPM	6	2	2	40	370,-	965-228 80,-	963-128 112,-
FFN 15K5IPM	15	5	5	100	370,-	965-228 80,-	963-128 112,-
FFN 25K10IPM	25	10	10	200	370,-	965-228 80,-	963-128 112,-



Bench scale, protected by stainless steel and protection type IP68, also with EC type approval [M]

Features

- Ideal for the increased hygienic requirements in the food industries
- Your support in a HACCP-compliant quality system
- Ideal for the robust industrial applications
- Dust and splash water protection type IP68. Therefore very robust and durable. Ideal for rough environmental conditions. Even immersion of the scale in water possible
- Thanks to the stainless steel design of the housing and platform with smooth surface, the scale is rust-free and easy to clean
- Very fast display: steady weight values within 2 s
- High mobility: thanks to battery operation, compact, lightweight construction, it is suitable for the use in several locations (kitchens, sales offices, cafeterias, food industry laboratories, etc.)

- 1 Recessed grips on the underside of the scale for easy transportation
- Weighing with tolerance range (check-weighing): a visual and audible signal helps with portioning, dispensing or grading

Technical data

- Large backlit LCD display, digit height 25 mm
- Dimensions weighing surface, stainless steel, WxD 236x195 mm
- Ready for use: Batteries standard, 4x1.5 V Size D, operating time approx. 500 h, AUTO-OFF function to preserve the battery
- Net weight approx. 3,4 kg
- Permissible ambient temperature -10 °C/40 °C

Accessories

- 2 Tare pan made from stainless steel, overall dimensions WxDxH, 400x300x45 mm, KERN RFS-A02, € 75,-

Note: Official verification is mandatory for commercial trade.

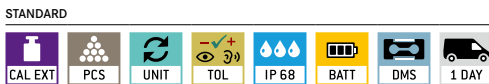

Model	Weighing capacity [Max] kg	Readability [d] g	Verification value [e] g	Minimal load [Min] g	Smallest part weight [Normal] g/piece	Price excl. of VAT ex works €	Option			
							Verification KERN	DAkkS	Calibr. Certificate	
KERN FXN 3K-4N	3	0,5	-	-	5	550,-	-	-	963-127	93,-
KERN FXN 6K-3N	6	1	-	-	10	550,-	-	-	963-128	112,-
KERN FXN 10K-3N	15	2	-	-	20	550,-	-	-	963-128	112,-
KERN FXN 30K-3N	30	5	-	-	50	550,-	-	-	963-128	112,-

Note: For applications that require verification, please order verification at the same time, initial verification at a later date is not possible.

Verification at the factory, we need to know the full address of the location of use.

KERN FXN 3K-3M	3	1	1	20	5	610,-	965-227	62,-	963-127	93,-
KERN FXN 6K-3M	6	2	2	40	10	610,-	965-228	80,-	963-128	112,-
KERN FXN 10K-3M	15	5	5	100	20	610,-	965-228	80,-	963-128	112,-
KERN FXN 30K-2M	30	10	10	200	50	610,-	965-228	80,-	963-128	112,-



Please note: only one optional interface can be fitted for each one

Stainless steel platform scales with IP65/67 protection, also with XL platform or EC type approval [M]

Features

- Ideal for the robust industrial applications
- 1** Platform: made entirely of stainless steel, silicone-coated Stainless Steel load cell, protection against dust and water splashes IP67
- 2** Display device: Stainless steel, protection against dust and water splashes IP65, (only when using rechargeable battery pack)
- 3** KERN SFB-H: Column, standard, for models with weighing plate size 300×240 mm: Height of stand approx. 200 mm 400×300 mm: Height of stand approx. 400 mm

Technical data

- Large backlit LCD display, digit height 52 mm
- Dimensions of display device W×D×H 266×165×96 mm
- Weighing plate dimensions, stainless steel
 - A** W×D×H 300×240×105 mm
 - B** W×D×H 400×300×105 mm
 - C** W×D×H 500×400×137 mm
 - D** W×D×H 650×500×142 mm
- KERN SFB: Cable length of display device approx. 3 m
- Rechargeable battery pack integrated, as standard, operating time up to 35 h without backlight, charging time approx. 12 h
- Permissible ambient temperature -10 °C/40 °

Accessories

- 4** KERN SFB: Stand to be screwed onto the platform, height of stand approx. 600 mm, KERN SFB-A01, € 110,-
- 5** KERN SFB: Stand to elevate display device, height of stand approx. 800 mm, KERN BFN-A04, € 355,-
- Data interface RS-232, interface cable included, approx. 1,5 m, must be ordered at purchase, KERN KFN-A01, € 220,-
- Bluetooth data interface for wireless data transfer to PC or tablets, must be ordered at purchase, not in combination with verification, KERN KFB-A03, € 160,-
- Analogue module 0-10 V, must be ordered at purchase, KERN KFB-A04, € 170,-
- Analogue module 4-20 mA, must be ordered at purchase, KERN KFB-A05, € 170,-
- Further details, plenty of further accessories and suitable printers see *Accessories*

STANDARD

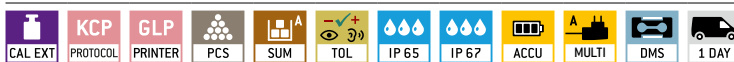

OPTION



FACTORY

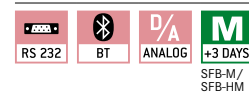

Model	Weighing capacity [Max] kg	Readability [d] g	Verification value [e] g	Minimal load [Min] g	Net weight approx. kg	Weighing plate W×D	Price excl. of VAT ex works €	Verification KERN €	Option DAKKS Calibr. Certificate DAKKS KERN €	
KERN SFB 50K-3XL	50	5	-	-	14	C	1050,-	-	963-128 112,-	
SFB 100K-2XL	100	10	-	-	24	D	1560,-	-	963-129 139,-	
with elevated display										
SFB 10K1HIP	10	1	-	-	8	A	930,-	-	963-128 112,-	
SFB 20K2HIP	20	2	-	-	8	A	930,-	-	963-128 112,-	
SFB 50K5HIP	50	5	-	-	8	A	930,-	-	963-128 112,-	
SFB 50K5LHIP	50	5	-	-	10	B	890,-	-	963-128 112,-	
SFB 100K10HIP	100	10	-	-	10	B	940,-	-	963-129 139,-	
Note: For applications that require verification, please order verification at the same time, initial verification at a later date is not possible. Verification at the factory, we need to know the full address of the location of use.										
SFB 60K-2XLM	60	20	20	400	14	C	1220,-	965-229 105,-	963-129 139,-	
SFB 100K-2LM	150	50	50	1000	14	C	1310,-	965-229 105,-	963-129 139,-	
SFB 100K-2XLM	150	50	50	1000	24	D	1560,-	965-229 105,-	963-129 139,-	
with elevated display										
SFB 15K5HIPM	15	5	5	100	8	A	950,-	965-228 80,-	963-128 112,-	
SFB 30K10HIPM	30	10	10	200	8	A	950,-	965-228 80,-	963-128 112,-	
SFB 60K20LHIPM	60	20	20	400	10	B	960,-	965-229 105,-	963-129 139,-	
SFB 100K-2HM	150	50	50	1000	10	B	980,-	965-229 105,-	963-129 139,-	



07

Stainless steel platform scale with stainless steel IP68 display and EC type approval [M]



Piece counting



Recipe-weighing



Thanks to the stainless steel design of the housing and platform with smooth surface, the scale is rust-free and easy to clean



Features

- Ideal for the robust industrial applications
- **1** Platform: made entirely of stainless steel, hermetically welded stainless steel load cell, protection against dust and water splashes IP68. Substruction in wing design, extremely resistant to bending. Earthed weighing plate, to reduce static charge
- Display device: stainless steel, dust and splash water protection IP68, integrated power supply
- Ideal for the increased hygienic requirements in the food industries
- Wall mount for display device, standard
- Superior display size: digit height 55 mm, bright backlight for easy reading of weighing results, even in poor lighting conditions
- Easy-to use KERN menu structure with printout of weighing results which can be intuitively adapted
- Thanks to interfaces such as RS-232, RS-485 and Bluetooth (optional) the scale can easily be connected to existing networks and facilitates the data exchange between the scale and printer



Technical data

- Large backlit LCD display, digit height 55 mm
- Weighing plate dimensions, stainless steel
 - A** W×D×H 300×240×86 mm
 - B** W×D×H 400×300×89 mm
 - C** W×D×H 500×400×123 mm
 - D** W×D×H 650×500×133,5 mm
- Dimensions of display device W×D×H 232×150×80 mm
- Cable length of display device approx. 2,5 m
- Permissible ambient temperature -10 °C/40 °C

Note: It is only possible to install one cable option. Either KXS-A04, KXS-A01 or KXS-A03



Accessories

- **2** Stand to elevate display device, for models with weighing plate size
 - A - D** Height of stand approx. 200 mm, KERN IXS-A02, **€ 118,-**
 - B - D** Height of stand approx. 400 mm, KERN IXS-A03, **€ 95,-**
 - C - D** Height of stand approx. 600 mm, KERN IXS-A04, **€ 120,-**
- **3** Internal rechargeable battery pack, operating time up to 80 h without backlight, charging time approx. 12 h, must be ordered at purchase, KERN GAB-A04, **€ 42,-**
- Foot switch, must be ordered at purchase, KERN KXS-A03, **€ 140,-**
- Data interface RS-232, interface cable included, approx. 1,5 m, must be ordered at purchase, KERN KXS-A04, **€ 109,-**
- Data interface RS-485, must be ordered at purchase, KERN KXS-A01, **€ 160,-**
- Bluetooth data interface for wireless data transfer, must be ordered at purchase, not in combination with verification, KERN KXS-A02, **€ 200,-**
- Further details, plenty of further accessories and suitable printers see *Accessories*

STANDARD



OPTION



FACTORY

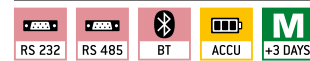

Model	Weighing capacity [Max] kg	Readability [d] g	Verification value [e] g	Minimal load [Min] g	Linearity g	Weighing plate	Price excl. of VAT ex works €	Verification KERN	Option DAKKS Calibr. Certificate DAKKS KERN	Certificate €
High resolution readability										
SXS 6K-3	6	0,5	-	-	± 1,5	A	1190,-	-	-	963-128 112,-
SXS 10K-3	15	1	-	-	± 3	A	1670,-	-	-	963-128 112,-
SXS 10K-3L	15	1	-	-	± 3	B	1190,-	-	-	963-128 112,-
SXS 30K-2	30	2	-	-	± 6	B	1460,-	-	-	963-128 112,-
SXS 30K-2L	30	2	-	-	± 6	C	1800,-	-	-	963-128 112,-
SXS 60K-2	60	5	-	-	± 15	B	1470,-	-	-	963-129 139,-
SXS 60K-2L	60	5	-	-	± 15	C	1800,-	-	-	963-129 139,-
SXS 100K-2	150	10	-	-	± 30	C	1790,-	-	-	963-129 139,-
SXS 100K-2L	150	10	-	-	± 30	D	2220,-	-	-	963-129 139,-
SXS 300K-2	300	20	-	-	± 60	D	2210,-	-	-	963-129 139,-

Multi-range balance, with increasing load it switches automatically to the next largest weighing range [Max] and readout [d] and when the load is fully removed, the balance switches back to the lower range

SXS 6K-3M	3 6	1 2	1 2	20 40	± 1 2	A	1110,-	965-228 80,-	963-128 112,-
SXS 10K-3M	6 15	2 5	2 5	40 100	± 2 5	A	1350,-	965-228 80,-	963-128 112,-
SXS 10K-3LM	6 15	2 5	2 5	40 100	± 2 5	B	1450,-	965-228 80,-	963-128 112,-
SXS 30K-2M	15 30	5 10	5 10	100 200	± 5 10	B	1360,-	965-228 80,-	963-128 112,-
SXS 30K-2LM	15 30	5 10	5 10	100 200	± 5 10	C	1670,-	965-228 80,-	963-128 112,-
SXS 60K-2M	30 60	10 20	10 20	200 400	± 10 20	B	1370,-	965-229 105,-	963-129 139,-
SXS 60K-2LM	30 60	10 20	10 20	200 400	± 10 20	C	1680,-	965-229 105,-	963-129 139,-
SXS 100K-2M	60 150	20 50	20 50	400 1000	± 20 50	C	2070,-	965-229 105,-	963-129 139,-
SXS 100K-2LM	60 150	20 50	20 50	400 1000	± 20 50	D	2070,-	965-229 105,-	963-129 139,-
SXS 300K-2M	150 300	50 100	50 100	1000 2000	± 50 100	D	2060,-	965-229 105,-	963-129 139,-

Note: For applications that require verification, please order verification at the same time, initial verification at a later date is not possible.

Verification at the factory, we need to know the full address of the location of use.

1 ONLY WHILE STOCKS LAST



08

PRICE COMPUTING SCALES

Price computing scales are used wherever the price of goods is calculated dependent on the weight of the goods. These scales are subject to obligatory verification (► **Verification**) in accordance with European Directive 2014/31/EU. Usually, these are verification class **MIII** scales

KERN mobile retail scales are compact in size and therefore save space on the sales counter. Thanks to the simple menu structure they are easy to use – saving time and money. Fitted with mains or rechargeable batteries as standard, price computing scales can be used in retail shops as well as on mobile sales stalls.

All price computing scales from KERN have three displays showing you all important information at a glance:

- Weight display in kg (verifiable)
- Unit price in €/kg or €/100 g
- Total price in €

NOTE: The KERN RFE range also displays the TARE or PRE-TARE value, which enables this value to be stored in a legally binding way in accordance with the Weights and Measures Act.

All KERN retail scales have direct access keys for memories (► **PLU**). The sales item with the relevant price can be stored against these PLU. In this way, frequently used sales items can be called up at lightning speed. This accelerates customer service and reduces waiting times.

► See the glossary on page 223–225

Quick-Finder Price computing scales

Readability [d] g	Weighing capacity [Max] kg	Model KERN	Price excl. of VAT ex works €	Page						
0,5 1	1,5 3	RPB 3K3DM	275,-	76	1	○	●	●	●	○
0,5 1	1,5 3	RPB 3K3DHM	300,-	76	1	○	●	●	●	○
1 2	3 6	RIB 6K-3M	280,-	75	1	○	●	●	●	○
1 2	3 6	RIB 6K-3HM	325,-	75	1	○	●	●	●	○
1 2	3 6	RPB 6K1DM	285,-	76	1	○	●	●	●	○
1 2	3 6	RPB 6K1DHM	300,-	76	1	○	●	●	●	○
1 2	3 6	RFE 6K3M	380,-	77	1	○	●	●	●	○
2 5	6 15	RIB 10K-3M	280,-	75	1	○	●	●	●	○
2 5	6 15	RIB 10K-3HM	325,-	75	1	○	●	●	●	○
2 5	6 15	RPB 15K2DM	285,-	76	1	○	●	●	●	○
2 5	6 15	RPB 15K2DHM	300,-	76	1	○	●	●	●	○
2 5	6 15	RFE 15K3M	380,-	77	1	○	●	●	●	○
5 10	15 30	RIB 30K-2M	280,-	75	1	○	●	●	●	○
5 10	15 30	RIB 30K-2HM	325,-	75	1	○	●	●	●	○
5 10	15 30	RPB 30K5DM	285,-	76	1	○	●	●	●	○
5 10	15 30	RPB 30K5DHM	300,-	76	1	○	●	●	●	○
5 10	15 30	RFE 30K3M	380,-	77	1	○	●	●	●	○

For an explanation on the pictos, see front flap

● = standard

○ = option

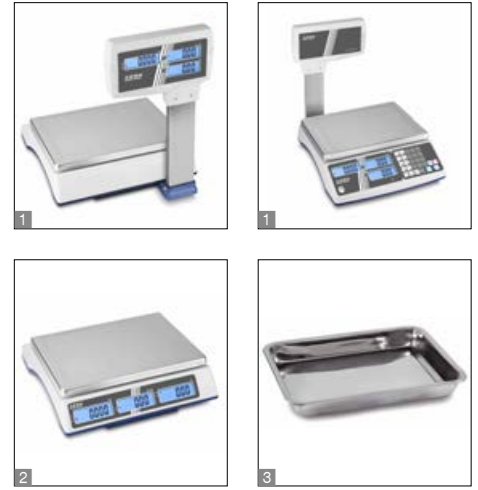

Robust retail scale with large item memory, user-friendly handling and EC type approval [M]

Features

- **1** KERN RIB-HM: Elevated display backlit, height of stand approx. 405 mm
- **2** KERN RIB-M: Second display on the back of the balance
- Three displays for weight display (verifiable), unit price, total price
- 10 direct price keys for frequently recurring article prices
- Memory (PLU) for 20 article prices
- Energy management: Backlight turns off after 5 sec, can be switched off
- Soil-resistant construction through water channels at the frame of the housing and sealing rings over the upper housing inlets
- Protective working cover included with delivery

Technical data

- Large backlit LCD displays, digit height 18 mm
- Weighing plate dimensions, stainless steel, WxD 294x225 mm
- Overall dimensions WxDxH
KERN RIB-M: 325x340x115 mm
KERN RIB-HM: 325x340x405 mm
- Net weight
KERN RIB-M: approx. 3,2 kg
KERN RIB-HM: approx. 3,8 kg
- Permissible ambient temperature -10 °C/40 °C

Accessories

- Protective working cover, scope of delivery 5 items, KERN RIB-A01S05, **€ 44,-**
- Internal rechargeable battery pack, operating time up to 80 h without backlight, charging time approx. 14 h, KERN GAB-A04, **€ 42,-**
- **3** Tare pan made from stainless steel, overall dimensions WxDxH, 400x300x45 mm, KERN RFS-A02, **€ 75,-**

Application examples

- retail shops
 - weekly markets
 - farm shops
 - pick your own fruit and vegetable sales
- Note:** Official verification is mandatory for commercial trade



Model	Weighing capacity	Readability	Verification value	Minimal load	Price excl. of VAT ex works €	Verification KERN €	Option DAkkS Calibr. Certificate DAkkS KERN €
	[Max] kg	[d] g	[e] g	[Min] g			
Multi-range balance, with increasing load it switches automatically to the next largest weighing range [Max] and readout [d] and when the load is fully removed, the balance switches back to the lower range							
RIB 6K-3M	3 6	1 2	1 2	20 40	280,-	965-228	80,- 963-128 112,-
RIB 10K-3M	6 15	2 5	2 5	40 100	280,-	965-228	80,- 963-128 112,-
RIB 30K-2M	15 30	5 10	5 10	100 200	280,-	965-228	80,- 963-128 112,-
with elevated display							
RIB 6K-3HM	3 6	1 2	1 2	20 40	325,-	965-228	80,- 963-128 112,-
RIB 10K-3HM	6 15	2 5	2 5	40 100	325,-	965-228	80,- 963-128 112,-
RIB 30K-2HM	15 30	5 10	5 10	100 200	325,-	965-228	80,- 963-128 112,-

Note: For applications that require verification, please order verification at the same time, initial verification at a later date is not possible.
Verification at the factory, we need to know the full address of the location of use.



Retail scale with memories for 10 item prices - now with Checkout-Dialogue 06

Features

- Modern, ergonomic design and a housing which is even more compact, supporting efficient operation and saving space
- **1** KERN RPB-HM: Elevated display backlit, revolving on column, height of stand approx. 480 mm
- **2** KERN RPB-M: Second display on the back of the balance
- Three displays for weight display (verifiable), unit price, total price
- Memory (PLU) for 10 article prices
- Unit price can be switched from €/kg to €/100 g
- Auto-clear-key: Unit price entry is automatically set to zero when scale is unloaded
- **3** High mobility: thanks to rechargeable battery operation (optional), compact,

lightweight construction, it is suitable for the use in several locations

- Protective working cover included with delivery

Technical data

- Large backlit LCD displays, digit height 15 mm
- Weighing plate dimensions, stainless steel, W×D 204×263 mm
- Overall dimensions W×D×H
KERN RPB-M: 283×318×100,3 mm
KERN RPB-HM: 283×375,5×486,8 mm
- Net weight
KERN RPB-M: approx. 2,8 kg
KERN RPB-HM: approx. 3,2 kg
- Permissible ambient temperature -10 °C/40 °C

4 Checkout Dialog 06: This dialog describes the communication procedure between a checkout scale in customer traffic and a freely programmable POS system, consisting of POS hardware and software. The aim of the Checkout Dialog 06 is to make manipulation of the data streams by third parties in principle impossible in freely programmable POS systems. Note: Other protocols on request.

Accessories

- Protective working cover, scope of delivery 5 items, KERN RFC-A02S05, € 44,-
- Internal rechargeable battery pack, operating time up to 60 h without backlight, charging time approx. 12 h, KERN WTB-A01N, € 38,-
- Tare pan made from stainless steel, overall dimensions W×D×H, 400×300×45 mm, KERN RFS-A02, € 75,-
- Further details, plenty of further accessories and suitable printers see *Accessories*

Application examples

- retail shops
- weekly markets
- farm shops
- pick your own fruit and vegetable sales

Note: Official verification is mandatory for commercial trade.

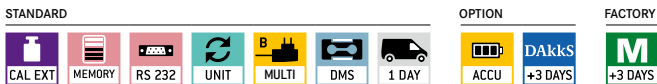

Model	Weighing capacity [Max] kg	Readability [d] g	Verification value [e] g	Minimal load [Min] g	Price excl. of VAT ex works €	Option			
						Verification KERN €	DAKKS KERN €	Calibr. Certificate €	
Multi-division balance, with increasing or decreasing load, it switches automatically to the next largest or smallest weighing range [Max] and readout [d].									
RPB 3K3DM	1,5 3	0,5 1	0,5 1	10	275,-	965-227	62,-	963-127	93,-
RPB 6K1DM	3 6	1 2	1 2	20	285,-	965-228	80,-	963-128	112,-
RPB 15K2DM	6 15	2 5	2 5	40	285,-	965-228	80,-	963-128	112,-
RPB 30K5DM	15 30	5 10	5 10	100	285,-	965-228	80,-	963-128	112,-
with elevated display									
RPB 3K3DHM	1,5 3	0,5 1	0,5 1	10	300,-	965-227	62,-	963-127	93,-
RPB 6K1DHM	3 6	1 2	1 2	20	300,-	965-228	80,-	963-128	112,-
RPB 15K2DHM	6 15	2 5	2 5	40	300,-	965-228	80,-	963-128	112,-
RPB 30K5DHM	15 30	5 10	5 10	100	300,-	965-228	80,-	963-128	112,-

Note: For applications that require verification, please order verification at the same time, initial verification at a later date is not possible. Verification at the factory, we need to know the full address of the location of use.



Compact portion scale with 2 XXL displays – weight, unit price, total price and TARE value at a glance

Features

- Ideal as a salad scale, sweet scale, check-weigher, portion scale or zero-waste scale: Shopping without plastic or packaging waste in packaging-free supermarkets
- Large LCD display with four displays for weight display (verifiable), unit price, total price and stored TARE or PRE-TARE value
- TARE value display: this shows a TARE or PRE-TARE value stored in a PLU, which enables this value to be stored in a legally binding way in accordance with the Weights and Measures Act
- 1 Second display on the back of the balance
- 2 Column to elevate the display as standard, can be easily fitted or removed by the user. The power cable for the second display can be stored in the folding column which is hygienic and gives a tidy appearance. Height of stand approx. 395 mm

- 3 Thanks to easily-understandable, universal symbols e.g. for weight, piece weight, total price this balance can also be understood and operated easily all over the world
- 4 direct price keys for frequently recurring article prices
- Memory (PLU) for 100 article prices
- Article description can be entered, displayed and printed in plain text
- Unit price can be switched from €/kg to €/100 g
- Auto-clear-key: Unit price entry is automatically set to zero when scale is unloaded
- Up to three headers and footers of the printout can be programmed directly on the balance
- High mobility: thanks to rechargeable battery operation (optional), compact, light-weight construction, it is suitable for the use in several locations
- Recessed grips on the underside of the scale for easy transportation

Application examples

- cafeterias, restaurants, Motorway service stations
- retail shops
- weekly markets
- farm shops
- pick your own fruit and vegetable sales

Note: Official verification is mandatory for commercial trade.

Technical data

- Large backlit LCD displays, digit height 20 mm
- Weighing plate dimensions, stainless steel, WxD 230x300 mm
- Overall dimensions WxDxH 320x450x130 mm 320x450x410 mm (incl. stand)
- Net weight approx. 4,2 kg
- Permissible ambient temperature -10 °C/40 °C

Accessories

- Affordable universal label printer to print out weights on thermal labels. ASCII-capable. Convenient Auto-Forward function to automatically jump from label to label (only with KERN standard labels), KERN YKE-01, € 790,-
- Internal rechargeable battery pack, operating time up to 30 h with backlight, charging time approx. 12 h, KERN GAB-A04, € 42,-

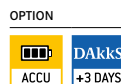

Model	Weighing capacity [Max] kg	Readability [d] g	Verification value [e] g	Minimal load [Min] g	Price excl. of VAT ex works €	Option		
						Verification KERN €	DAKKS KERN €	Calibr. Certificate KERN €
Multi-division balance, with increasing or decreasing load, it switches automatically to the next largest or smallest weighing range [Max] and readout [d].								
RFE 6K3M	3 6	1 2	1 2	20	380,-	965-228 80,-	963-128	112,-
RFE 15K3M	6 15	2 5	2 5	40	380,-	965-228 80,-	963-128	112,-
RFE 30K3M	15 30	5 10	5 10	100	380,-	965-228 80,-	963-128	112,-

Note: For applications that require verification, please order verification at the same time, initial verification at a later date is not possible. Verification at the factory, we need to know the full address of the location of use.



COUNTING SCALES/ COUNTING SYSTEMS

Interesting Facts about Counting

Smallest part weight for piece counting

This is the smallest piece weight the scale will accept for piece counting and will display it piece by piece. In practice, depending on the required accuracy, we recommend to choose a counting scale with a minimum piece weight smaller than the weight of the item to be counted. To make it easier for you to select the right model, we specify the smallest part weight when counting under laboratory conditions and normal conditions, see the website.

► **Counting resolution**

Describes the maximum quantity which can be counted with a counting accuracy of 1 %, with a minimum variation of item weights and a sufficiently large ► **reference quantity** (20 pieces with counting resolution $\leq 60,000$ points, 50 pieces from 60,000–150,000 points, 100 pieces $\geq 150,000$ points). This therefore is an indication of the quality of the counting scale.

Recommended ► **reference quantity**

Weight tolerances of pieces to be counted are the most significant sources of error when counting. Therefore, at the start of every counting procedure, establish an average weight, the so-called ► **reference weight**, by placing several pieces on the balance, the so-called reference quantity. Usually this would be:

- 5 pieces >> often sufficient
- 10 pieces >> common practise
- 20–100 pieces >> for large deviations among piece weights

The “automatic ► **reference optimisation**” function increases the reference quantity gradually, whereby the average piece weight is optimised step by step. This contributes considerably to the accuracy of the subsequent counting processes.

Which Counting Scale for Which Application?

Simple counting scale

With self-explanatory user guidance on the keyboard. The graphic control panel enables you to start working immediately, without having to consult the user manual. Easy handling, value for money.

Professional counting scale

With 3 separate displays for reference weight (average weight of the pieces), total weight of all pieces and total quantity of all pieces. Very useful integrated memories, e.g. for container weight, item number, reference weight as well as audible and visual counting aids and an alphanumeric key pad for easy data entry.

Special tip for counting large quantities:

Counting systems

The weighing capacities of bench counting scales are often not sufficient to count large quantities, units, palletized items, etc. In this case, high-performing counting systems come into operation, as these combine a high-precision reference scale with a high-capacity bulk scale.

► **See the glossary on page 223–225**

Quick-Finder Counting scales/Counting systems

Readability [d] g	Weighing capacity [Max] kg	Smallest part weight [Normal] g/piece	Counting resolution Points	Model KERN	Price excl. of VAT ex works €	Page															
							For an explanation on the pictos, see front flap														
0,001	0,3	0,05	60.000	CFS 300-3	550,-	84	1														
0,001	0,36	0,01	360.000	CKE 360-3	405,-	85	1														
0,001	6	0,05	1.200.000	CCS 6K-6	710,-	90	2														
0,001	15	0,05	3.000.000	CCS 10K-6	790,-	90	2														
0,01	3	0,5	60.000	CFS 3K-5	425,-	84	1														
0,01	3,6	0,1	360.000	CKE 3600-2	435,-	85	1														
0,01	3 6	0,2	300.000	CCA 6K-5M	1090,-	88	2														
0,01	6 15	0,2	750.000	CCA 10K-5M	1090,-	88	2														
0,01	15 30	0,2	1.500.000	CCA 30K-5M	1190,-	88	2														
0,01	30	0,5	600.000	CCS 30K0.01.	780,-	90	2														
0,01	30 60	0,2	3.000.000	CCA 60K-5M	1200,-	88	2														
0,01	60	0,5	1.200.000	CCS 60K0.01.	770,-	90	2														
0,01	60	0,5	1.200.000	CCS 60K0.01L.	820,-	90	2														
0,01	60 150	0,2	7.500.000	CCA 100K-5M	1350,-	88	2														
0,01	150	0,5	3.000.000	CCS 150K0.01	900,-	90	2														
0,01	150	0,5	3.000.000	CCS 150K0.01L	1130,-	90	2														
0,01	150 300	0,2	15.000.000	CCA 300K-5M	1620,-	88	2														
0,01	300	0,5	6.000.000	CCS 300K0.01	1220,-	90	2														
0,01	600	0,5	12.000.000	CCS 600K-2U	2040,-	90	4*														
0,01	600	0,5	12.000.000	CCS 600K-2L	2950,-	90	4*														
0,02	4	0,2	200.000	CDS 4K0.02	640,-	87	1														
0,02	6	0,2	300.000	CKE 6K0.02	560,-	85	1														
0,05	8	0,5	160.000	CKE 8K0.05	510,-	85	1														
0,05	15	0,5	300.000	CDS 15K0.05	600,-	87	1														
0,05	16	0,5	320.000	CKE 16K0.05	620,-	85	1														
0,1	6	1	60.000	CPB 6K0.1N	310,-	83	1														
0,1	6	1	60.000	CFS 6K0.1	365,-	84	1														
0,1	3 6	1	60.000	CCA 6K-4M	1050,-	88	2														
0,1	6 15	1	150.000	CCA 10K-4M	1050,-	88	2														
0,1 0,2	3 6	1	60.000	IFS 6K-4S	550,-	86	1														
0,1 0,2	6 15	2	75.000	IFS 10K-4	590,-	86	1														
0,1	16	1	160.000	CKE 16K0.1	540,-	85	1														
0,1	16	1	160.000	CDS 16K0.1	600,-	87	1														
0,1	30	1	300.000	CDS 30K0.1	670,-	87	1														
0,1	30	1	300.000	CDS 30K0.1L	1080,-	87	1														
0,1	30	1	300.000	CCS 30K0.1.	720,-	90	2														
0,1	15 30	1	300.000	CCA 30K-4M	1150,-	88	2														
0,1	36	1	360.000	CKE 36K0.1	580,-	85	1														
0,1	30 60	1	600.000	CCA 60K-4M	1150,-	88	2														
0,1	60	1	600.000	CCS 60K0.1.	780,-	90	2														
0,1	60	1	600.000	CCS 60K0.1L.	870,-	90	2														
0,1	60 150	1	1.500.000	CCA 100K-4M	1300,-	88	2														
0,1	150	1	1.500.000	CCS 150K0.1	810,-	90	2														
0,1	150	1	1.500.000	CCS 150K0.1L	1145,-	90	2														
0,1	150 300	1	3.000.000	CCA 300K-4M	1610,-	88	4*														
0,1	300	1	3.000.000	CCS 300K0.1	1160,-	90	4*														
0,1	600	1	6.000.000	CCS 600K-1S	1890,-	90	4*														
0,1	600	1	6.000.000	CCS 600K-1	2350,-	90	4*														
0,1	1500	1	15.000.000	CCS 1T-4S	1890,-	90	4*														
0,1	1500	1	15.000.000	CCS 1T-1U	1940,-	90	4*														
0,1	1500	1	15.000.000	CCS 1T-4	2350,-	90	4*														
0,1	1500	1	15.000.000	CCS 1T-1L	2900,-	90	4*														
0,1	3000	1	30.000.000	CCS 3T-3L	2690,-	90	4*														
0,1	3000	1	30.000.000	CCS 3T-3	2350,-	90	4*														
0,1	3000	1	30.000.000	CCS 3T-1	2900,-	90	4*														
0,2	3	1	30.000	CIB 3K-4	280,-	81	1														
0,2	3	1	30.000	CXB 3K0.2	350,-	82	1														
0,2	15	2	75.000	CFS 15K0.2	365,-	84	1														
0,2	15	2,5	60.000	CPB 15K0.2N	310,-	83	1														
0,2	36	2	180.000	CDS 36K0.2L	1070,-	87	1														
0,2	60	2	300.000	CDS 60K0.2	1070,-	87	1														
0,2	65	2	325.000	CKE 65K0.2	570,-	85	1														
0,2 0,5	12 30	5	60.000	IFS 30K0.2DL	660,-	86	1														
0,5	6	2	30.000	CIB 6K-4	280,-	81	1														
0,5	6	2	30.000	CXB 6K0.5	350,-	82	1														
0,5	30	5	60.000	CPB 30K0.5N	310,-	83	1														
0,5	30	5	60.000	CFS 30K0.5	365,-	84	1														
0,5 1	30 60	10	60.000	IFS 60K0.5D	660,-	86	1														
0,5 1	30 60	10	30.000	IFS 60K0.5DL	810,-	86	1														
1	3	1	30.000	CXB 3K1NM	380,-	82	1														
1	15	5	30.000	CIB 10K-3	280,-	81	1														

* Shipment via freight forwarder. Please ask for dimensions, gross weight, shipping costs

● = standard ○ = option

Quick-Finder Counting scales/Counting systems

Readability [d] g	Weighing capacity [Max] kg	Smallest part weight [Normal] g/piece	Counting resolution Points	Model KERN	Price excl. of VAT ex works €	Page												
							For an explanation on the pictos, see front flap											
1	15	5	50.000	CXB 15K1	355,-	82	1	●										○
1	50	10	60.000	CFS 50K-3	425,-	84	1	●										○
1 2	3 6	1	60.000	CPB 6K1DM	315,-	83	1	○	●									○
1 2	3 6	1	60.000	IFS 6K-3SM	520,-	86	1	○	●									○
1 2	3 6	1	60.000	IFS 6K-3M	510,-	86	1	○	●									○
1 2	75 150	25	60.000	IFS 100K-3	920,-	86	1		●									○
1 2	75 150	25	30.000	IFS 100K-3L	1170,-	86	1		●									○
2	6	2	30.000	CXB 6K2NM	380,-	82	1	○	●									○
2	30	10	30.000	CIB 30K-3	280,-	81	1		●									○
2	30	10	75.000	CXB 30K2	350,-	82	1		●									○
2 5	6 15	2	75.000	IFS 10K-3M	510,-	86	1	○	●									○
2 5	6 15	2	60.000	IFS 10K-3LM	600,-	86	1	○	●									○
2 5	6 15	2,5	60.000	CPB 15K2DM	315,-	83	1	○	●									○
2 5	15 30	50	30.000	IFS 300K-3	1180,-	86	1		●									○
5	15	5	60.000	CXB 15K5NM	380,-	82	1	○	●									○
5 10	15 30	5	60.000	CPB 30K5DM	315,-	83	1	○	●									○
5 10	15 30	5	30.000	IFS 30K-3M	600,-	86	1	○	●									○
10	30	10	60.000	CXB 30K10NM	380,-	82	1	○	●									○
10 20	30 60	10	60.000	IFS 60K-2M	610,-	86	1	○	●									○
10 20	30 60	10	60.000	IFS 60K-2LM	760,-	86	1	○	●									○
20 50	60 150	25	60.000	IFS 100K-2M	760,-	86	1	○	●									○
20 50	60 150	25	60.000	IFS 100K-2LM	1020,-	86	1	○	●									○
50 100	150 300	50	60000	IFS 300K-2M	1020,-	86	1	○	●									○

* Shipment via freight forwarder. Please ask for dimensions, gross weight, shipping costs

● = standard ○ = option



Robust counting scale with large article memory, convenient operating philosophy and checkweighing display, counting resolution up to 30,000 points

Features

- Innovative counting with tolerance range (Checkweighing): The counting process can be supported visually and/or audibly and this therefore makes portion division, dispensing and grading easier
 - visual signal: the colour of the display changes depending on the counting result (not enough/ok/too much)
 - audible signal: the frequency of the audible signal changes depending on the counting result (not enough/ok/too much), can be switched off
- Ideal for workshops for people with disabilities, particularly loud or quiet environments, where operators change frequently, etc.
- Three displays for weight display, reference weight, total pieces
- Precise counting: The automatic reference weight optimisation of reference weight gradually improves the average piece weight value

- Programmable using numerical key pad:
 - required reference quantity
 - known reference weight
- Counting results memory: adds up all individual piece counts, result is shown in total weight and total pieces
- PRE-TARE function for manual subtraction of a known container weight, useful for checking fill-levels
- 20 direct price keys for frequently recurring reference weights and PRE-Tare values
- Memory for 50 reference weights and PRE-Tare values
- High mobility: thanks to rechargeable battery operation, compact, lightweight construction, it is suitable for the use in several locations (kitchen, sales office, cafeteria, Food industry-Laboratory etc.)
- Two balances in one: Changes from counting mode to weighing mode at the touch of a key
- Energy management: Backlight turns off after 5 sec, can be switched off
- Protective working cover included with delivery

Technical data

- Large backlit LCD displays, digit height 18 mm
- Dimensions weighing surface, stainless steel, WxD 315x215 mm
- Overall dimensions WxDxH, 350x330x120 mm
- Net weight approx. 3,6 kg
- Permissible ambient temperature -10 °C/40 °C

Accessories

- Protective working cover, scope of delivery 5 items, KERN RIB-A01S05, € 44,-
- Internal rechargeable battery pack, operating time up to 160 h without backlight, charging time approx. 14 h, KERN GAB-A04, € 42,-

STANDARD

CAL EXT PCS MEMORY SUM TOL ACCU MULTI DMS 1 DAY

OPTION

DAkkS +3 DAYS

Model	Weighing capacity [Max] kg	Readability [d] g	Smallest part weight [Normal] g/piece	Counting resolution Points	Price excl. of VAT ex works €	Option	
						DAkkS KERN	Calibr. Certificate €
KERN CIB 3K-4	3	0,2	1	30.000	280,-	963-127	93,-
KERN CIB 6K-4	6	0,5	2	30.000	280,-	963-128	112,-
KERN CIB 10K-3	15	1	5	30.000	280,-	963-128	112,-
KERN CIB 30K-3	30	2	10	30.000	280,-	963-128	112,-



Note: Official verification is mandatory for commercial trade

Entry level model for professional counting, with EC type approval [M], counting resolution of 30,000 points

Features

- Precise counting: The automatic reference weight optimisation of reference weight gradually improves the average piece weight value
- Programmable using numerical key pad:
 - required reference quantity
 - known reference weight
- Three displays for weight display (verifiable), reference weight, total pieces
- Fill-to-target function: Target count or target weight can be programmed. When the target weight is reached there is an audible and visual signal
- 10 memories for reference weights
- Counting results memory: adds up all individual piece counts, result is shown in total weight and total pieces

- Integrated ESD protection, which makes it ideal for weighing small plastic parts
- Energy management: Backlight turns off after 5 sec
- PRE-TARE function for manual subtraction of a known container weight, useful for checking fill-levels
- Two balances in one: Changes from counting mode to weighing mode at the touch of a key
- Protective working cover included with delivery

Technical data

- Large backlit LCD displays, digit height 18 mm
- Weighing plate dimensions, stainless steel, WxD 300x225 mm
- Overall dimensions WxDxH, 300x330x110 mm
- Rechargeable battery pack integrated, as standard, operating time up to 200 h without backlight, charging time approx. 8 h
- Net weight approx. 4,0 kg
- Permissible ambient temperature -10 °C/40 °C

Accessories

- Protective working cover, scope of delivery 5 items, KERN CXB-A01S05, € 44,-
- Internal rechargeable battery pack, operating time up to 200 h without backlight, charging time approx. 8 h, KERN GAB-A04, € 42,-

STANDARD

OPTION

FACTORY

Model	Weighing capacity [Max]	Readability [d]	Verification value [e]	Minimal load [Min]	Smallest part weight [Normal]	Counting resolution	Net weight approx.	Price excl. of VAT ex works	Option			
									Verification	DAkkS	Calibr. Certificate	
KERN CXB 3K0.2	3	0,2	-	-	1	30.000	4,0	350,-	KERN	€	963-127	93,-
KERN CXB 6K0.5	6	0,5	-	-	2	30.000	4,0	350,-	-	-	963-128	112,-
KERN CXB 15K1	15	1	-	-	5	30.000	4,0	355,-	-	-	963-128	112,-
KERN CXB 30K2	30	2	-	-	10	30.000	4,0	350,-	-	-	963-128	112,-

Note: For applications that require verification, please order verification at the same time, initial verification at a later date is not possible. Verification at the factory, we need to know the full address of the location of use.

KERN CXB 3K1NM	3	1	1	20	1	30.000	4,0	380,-	965-227	62,-	963-127	93,-
KERN CXB 6K2NM	6	2	2	40	2	30.000	4,0	380,-	965-228	80,-	963-128	112,-
KERN CXB 15K5NM	15	5	5	100	5	30.000	3,8	380,-	965-228	80,-	963-128	112,-
KERN CXB 30K10NM	30	10	10	200	10	30.000	4,0	380,-	965-228	80,-	963-128	112,-



Note: Official verification is mandatory for commercial trade

Professional model, also with EC type approval [M], counting resolution up to 60,000 points

Features

- Precise counting: The automatic reference weight optimisation of reference weight gradually improves the average piece weight value
- Programmable using numerical key pad:
 - required reference quantity
 - known reference weight
- Three displays for weight display (verifiable), reference weight, total pieces
- Counting results memory: adds up all individual piece counts, result is shown in total weight and total pieces
- Fill-to-target function: Target count or target weight can be programmed. When the target weight is reached there is an audible and visual signal
- PRE-TARE function for manual subtraction of a known container weight, useful for checking fill-levels

- High mobility: thanks to rechargeable battery operation (optional), compact, lightweight construction, it is suitable for the use in several locations (production, warehouse, dispatch department etc.)
- Two balances in one: Changes from counting mode to weighing mode at the touch of a key
- Protective working cover included with delivery

Technical data

- Large backlit LCD displays, digit height 20 mm
- Weighing plate dimensions, stainless steel, WxD 295x225 mm
- Overall dimensions WxDxH, 315x350x100 mm
- Net weight approx. 3,2 kg
- Permissible ambient temperature 0 °C/40 °C

Accessories

- Protective working cover, scope of delivery 5 items, KERN CFS-A02S05, € 44,-
- Internal rechargeable battery pack, operating time up to 90 h without backlight, charging time approx. 12 h, KERN GAB-A04, € 42,-
- Signal lamp for visual support of weighing with tolerance range, KERN CFS-A03, € 330,-
- Y-cable for parallel connection of two terminal devices to the RS-232 interface on the scale, e.g. signal lamp and printer, KERN CFS-A04, € 38,-
- Further details, plenty of further accessories and suitable printers see *Accessories*

STANDARD										OPTION		FACTORY
CAL EXT	MEMORY	RS 232	KCP	PCS	SUM	TOL	MULTI	DMS	1 DAY	ACCU	+3 DAYS	+3 DAYS
											CPB-DM	

Model	Weighing capacity [Max] kg	Readability [d] g	Verification value [e] g	Minimal load [Min] g	Smallest part weight [Normal] g/piece	Counting resolution Points	Price excl. of VAT ex works €	Verification KERN	Option DAKKS	Calibr. KERN	Certificate DAKKS
KERN CPB 6K0.1N	6	0,1	-	-	1	60.000	310,-	-	-	963-128	112,-
KERN CPB 15K0.2N	15	0,2	-	-	2,5	60.000	310,-	-	-	963-128	112,-
KERN CPB 30K0.5N	30	0,5	-	-	5	60.000	310,-	-	-	963-128	112,-

Multi-division balance, with increasing or decreasing load, it switches automatically to the next largest or smallest weighing range [Max] and readout [d].

Note: For applications that require verification, please order verification at the same time, initial verification at a later date is not possible.

Verification at the factory, we need to know the full address of the location of use.

Model	3 6	1 2	1 2	20	1	60.000	Price €	Verification	Option	Calibr.	Certificate
KERN CPB 6K1DM	3 6	1 2	1 2	20	1	60.000	315,-	965-228	80,-	963-128	112,-
KERN CPB 15K2DM	6 15	2 5	2 5	40	2,5	60.000	315,-	965-228	80,-	963-128	112,-
KERN CPB 30K5DM	15 30	5 10	5 10	100	5	60.000	315,-	965-228	80,-	963-128	112,-

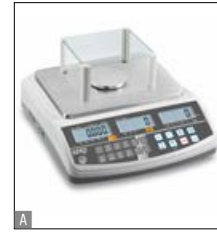

Professional, high-resolution counting scale with 100 item memories and second balance interface, counting resolution up to 75,000 points

Features

- Memory (PLU) for 100 items with additional text, reference weight and tare weight, e.g. of a container
- Precise counting: The automatic reference weight optimisation of reference weight gradually improves the average piece weight value
- Programmable using numerical key pad:
 - required reference quantity
 - known reference weight
- Three displays for weight display, reference weight, total pieces
- Weighing with tolerance range (checkweighing): a visual and audible signal helps with portioning, dispensing or grading
- Fill-to-target function: Programmable target quantity or target weight. A signal will be displayed when the target value is reached
- PRE-TARE function for manual subtraction of a known container weight, useful for checking fill-levels

- Second balance interface to construct a high-resolution counting system, standard, e.g. with weighing bridges of KERN KFP V20
- Draught shield standard for models with weighing plate size **A**, weighing space W×D×H 155×141×80 mm
- Protective working cover included with delivery, for models with weighing plate size **A**, **B**

Technical data

- Large backlit LCD displays, digit height 20 mm
- Dimensions weighing surface, stainless steel
 - A** ø 80 mm
 - B** W×D 295×225 mm, see larger picture
 - C** W×D 370×240 mm
- Overall dimensions W×D×H
 - A** 315×350×185 mm (incl. draught shield)
 - B** 315×350×125 mm
 - C** 370×360×125 mm
- Permissible ambient temperature 0 °C/40 °C

Accessories

- Fitting for models with weighing plate size **A**, **B**, Protective working cover, scope of delivery 5 items, KERN CFS-A02S05, € 44,-
- Internal rechargeable battery pack, operating time up to 70 h without backlight, charging time approx. 14 h, KERN GAB-A04, € 42,-
- Signal lamp for visual support of weighing with tolerance range, KERN CFS-A03, € 330,-
- Y-cable for parallel connection of two terminal devices to the RS-232 interface on the scale, e.g. signal lamp and printer, KERN CFS-A04, € 38,-
- Further details, plenty of further accessories and suitable printers see *Accessories*

STANDARD



OPTION



Model	Weighing capacity [Max] kg	Readability [d] g	Smallest part weight [Normal] g/piece	Counting resolution Points	Net weight approx. kg	Weighing plate	Price		
							excl. of VAT ex works €	Option DAKkS KERN	Calibr. Certificate €
KERN CFS 300-3	0,3	0,001	0,05	60.000	2,6	A	550,-	963-127	93,-
CFS 3K-5	3	0,01	0,5	60.000	3,4	B	425,-	963-127	93,-
CFS 6K0.1	6	0,1	1	60.000	3,2	B	365,-	963-128	112,-
CFS 15K0.2	15	0,2	2	75.000	3,4	B	365,-	963-128	112,-
CFS 30K0.5	30	0,5	5	60.000	3,4	B	365,-	963-128	112,-
CFS 50K-3	50	1	10	50.000	4,4	C	425,-	963-128	112,-



Easy to use, self-explanatory counting scale with laboratory accuracy, ideal for the various possibilities of Industry 4.0 applications, highly accurate, counting, accuracy, counting resolution up to 360,000 points

Features

- Self-explanatory, graphic control panel, the workings steps can be understood immediately, even without operating instructions
 - no learning time = reduces costs
 - ideal for untrained users
 - visualised process avoids operating errors
- The 4 steps are carried out from left to right:
 - 1 Place the empty container onto the weighing plate and tare by pressing the TARE key
 - 2 Place the reference quantity for the goods to be counted into the container (5, 10, 20 or any number of pieces)
 - 3 Confirm the selected reference quantity by pressing the key (5, 10, 20 or any number of pieces)
 - 4 Pour in the goods to be counted. The number of pieces will immediately be shown in the display

- Precise counting: The automatic reference weight optimisation of reference weight gradually improves the average piece weight value
- KERN Universal Port (KUP): permits the connection of an external KUP interface adapter, such as, for example, RS 232, USB, Bluetooth or Ethernet, for the exchange of data and control commands, without any installation outlay
- KERN Communication Protocol (KCP): The KCP permits searching and remote control of the balance using external control devices or computers. for details see page 8/9
- Two balances in one: Changes from counting mode to weighing mode at the touch of a key
- Ring-shaped draught shield standard, only for models with weighing plate size \varnothing 81 mm, weighing space \varnothing ×H 90×40 mm
- Protective working cover included with delivery

Technical data

- Large backlit display, digit height 25 mm
- Dimensions weighing surface
 - A \varnothing 81 mm, plastic
 - B W×D 130×130 mm, stainless steel
 - C W×D 340×240 mm, stainless steel, see larger picture
- Overall dimensions W×D×H
 - A, B 167×250×85 mm
 - C 350×390×120 mm
- Optional battery operation, 4× 1.5 V AA not included in scope of delivery, operating time up to 80 h
- Permissible ambient temperature -10 °C/40 °C

Accessories

- Protective working cover, scope of delivery 5 items, for models with weighing plate size
 - A, B, KERN YBA-A12S05, € 44,-
 - C, KERN FKB-A02S05, € 44,-
- A Internal rechargeable battery pack, operating time up to 48 h without backlight, charging time approx. 8 h, KERN YKR-01, € 35,-
- External data interface RS-232, Interface cable included, KERN YKUP-01, € 68,-
- External data interface USB, Interface cable included, KERN YKUP-03, € 98,-
- WiFi interface adapter, KERN YKUP-05, € 98,-
- Extension-Box, KERN YKUP-13, € 98,-
- Further details, plenty of further accessories and suitable printers see *Accessories*

STANDARD



OPTION

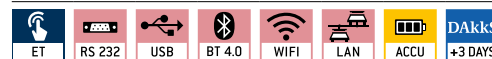

Model	Weighing capacity [Max] kg	Readability [d] g	Smallest part weight [Normal] g/piece	Counting resolution Points	Net weight approx. kg	Weighing plate	Price excl. of VAT ex works €	Option DAKKS Calibr. Certificate DAKKS KERN €
KERN CKE 360-3	0,36	0,001	0,01	360.000	1	A	405,-	963-127 93,-
KERN CKE 3600-2	3,6	0,01	0,1	360.000	1,8	B	435,-	963-127 93,-
KERN CKE 6K0.02	6	0,02	0,2	300.000	7	C	560,-	963-128 112,-
KERN CKE 8K0.05	8	0,05	0,5	160.000	7	C	510,-	963-128 112,-
KERN CKE 16K0.05	16	0,05	0,5	320.000	7	C	620,-	963-128 112,-
KERN CKE 16K0.1	16	0,1	1	160.000	7	C	540,-	963-128 112,-
KERN CKE 36K0.1	36	0,1	1	360.000	7	C	580,-	963-128 112,-
KERN CKE 65K0.2	65	0,2	2	325.000	7	C	570,-	963-129 139,-



- Cable length of display device approx. approx. 3 m
- Permissible ambient temperature -10 °C/40 °C

Industrial counting scale with convenient decimal keypad for easy data entry - now also with EC type approval [M], counting resolution up to 75000 points

Features

- Tough industry standard suitable for use in harsh industrial applications
- Ergonomic display device with large keypad and high-contrast LCD display for easy entry and reading of, e.g., tare weights, reference weights, limit values etc.
- Three displays for weight display (verifiable), reference weight, total pieces
- 100 item memories for master data such as reference weight, reference quantity, container weight (PRE-TARE) etc.
- Precise counting: The manual reference weight optimisation gradually improves the average value of the piece weight

- Totalising of pieces when counting
- Printout with date and time
- Protective working cover included with delivery

Technical data

- Large backlit LCD displays, digit height 16,5 mm
- Weighing plate dimensions, stainless steel
 - A W×D×H 230×230×110 mm
 - B W×D×H 300×240×110 mm
 - C W×D×H 400×300×120 mm
 - D W×D×H 500×400×140 mm
 - E W×D×H 650×500×140 mm
- Dimensions of display device W×D×H 260×150×65 mm

Accessories

- Protective working cover, scope of delivery 5 items, KERN KFB-A02S05, € 44,-
- Stand to elevate display device
 - 1 Height of stand approx. 330 mm, KERN IFB-A01, € 68,-
 - 2, 3: Height of stand approx. 600 mm, KERN IFB-A02, € 81,-
- Internal rechargeable battery pack, operating time up to 18 h without backlight, charging time approx. 12 h, must be ordered at purchase, KERN KFB-A01, € 40,-
- 2 ESD drain to protect against electrostatic discharge e.g. for electrostatically-charged weighing objects or people who work with the scale, KERN YGR-01, € 65,-
- Further details, plenty of further accessories and suitable printers see *Accessories*

STANDARD

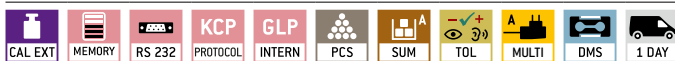

OPTION



FACTORY



Model	Weighing capacity [Max] kg	Readability [d] g	Verification value [e] g	[Min] g	Smallest part weight [Normal] g/piece	Net weight approx. kg	Weighing plate	Price excl. of VAT ex works €	Verification KERN	Option DAKkS Calibr. Certificate DAKkS KERN	Certificate €
Multi-range balance, with increasing load it switches automatically to the next largest weighing range [Max] and readout [d] and when the load is fully removed, the balance switches back to the lower range											
IFS 6K-4S	3 6	0,1 0,2	-		1	4,6	A	550,-	-	963-128	112,-
IFS 10K-4	6 15	0,1 0,2	-		2	6	B	590,-	-	963-128	112,-
IFS 30K0.2DL	12 30	0,2 0,5	-		5	11	C	660,-	-	963-128	112,-
IFS 60K0.5D	30 60	0,5 1	-		10	10	C	660,-	-	963-129	139,-
IFS 60K0.5DL	30 60	0,5 1	-		10	12	D	810,-	-	963-129	139,-
IFS 100K-3	75 150	1 2	-		25	12	D	920,-	-	963-129	139,-
IFS 100K-3L	75 150	1 2	-		25	20	E	1170,-	-	963-129	139,-
IFS 300K-3	150 300	2 5	-		50	22	E	1180,-	-	963-129	139,-

Note: For applications that require verification, please order verification at the same time, initial verification at a later date is not possible.

Verification at the factory, we need to know the full address of the location of use.

IFS 6K-3SM	3 6	1 2	1 2	20 40	1	6	A	520,-	965-228	80,-	963-128	112,-
IFS 6K-3M	3 6	1 2	1 2	20 40	1	6	B	510,-	965-228	80,-	963-128	112,-
IFS 10K-3M	6 15	2 5	2 5	40 100	2	6	B	510,-	965-228	80,-	963-128	112,-
IFS 10K-3LM	6 15	2 5	2 5	40 100	2	10	C	600,-	965-228	80,-	963-128	112,-
IFS 30K-3M	15 30	5 10	5 10	100 200	5	10	C	600,-	965-228	80,-	963-128	112,-
IFS 60K-2M	30 60	10 20	10 20	200 400	10	11	C	610,-	965-229	105,-	963-129	139,-
IFS 60K-2LM	30 60	10 20	10 20	200 400	10	13	D	760,-	965-229	105,-	963-129	139,-
IFS 100K-2M	60 150	20 50	20 50	400 1000	25	12	D	760,-	965-229	105,-	963-129	139,-
IFS 100K-2LM	60 150	20 50	20 50	400 1000	25	22	E	1020,-	965-229	105,-	963-129	139,-
IFS 300K-2M*	150 300	50 100	50 100	1000 2000	50	22	E	1020,-	965-229	105,-	963-129	139,-

* ONLY WHILE STOCKS LAST



Easy to use industrial counting scale for heavy loads, ideal for the various possibilities of Industry 4.0 applications, counting resolution up to 300,000 points

Features

- Self-explanatory, graphic control panel, the workings steps can be understood immediately, even without operating instructions
 - no learning time = reduces costs
 - ideal for untrained users
 - visualised process avoids operating errors
- The 4 steps are carried out from left to right:
 - 1 Place the empty container onto the weighing plate and tare by pressing the TARE key
 - 2 Place the reference quantity for the goods to be counted into the container (5, 10 or 20 pieces)
 - 3 Confirm the selected reference quantity by pressing the key (5, 10 or 20)
 - 4 Pour in the goods to be counted. The number of pieces will immediately be shown in the display
- Precise counting: The automatic reference weight optimisation of reference weight gradually improves the average piece weight value

- KERN Universal Port (KUP): permits the connection of an external KUP interface adapter, such as, for example, RS 232, USB, Bluetooth or Ethernet, for the exchange of data and control commands, without any installation outlay
- KERN Communication Protocol (KCP): The KCP permits searching and remote control of the balance using external control devices or computers, for details see page 8/9
- Standardised, simplified concept of operation
- Protective working cover included with delivery

Technical data

- Backlit LCD display, digit height 21 mm
- Dimensions weighing surface, stainless steel
 - A W×D 228×228 mm
 - B W×D 308×318 mm, see larger picture
 - C W×D 500×400 mm
- Dimensions of display device W×D×H 225×115×60 mm
- Permissible ambient temperature -10 °C/40 °C

Accessories

- Protective working cover over the display device, scope of delivery 5 items, KERN DE-A12S05, € 44,-
- Mount to fasten the display device to the platform, for models with weighing plate size B, C, KERN DE-A11N, € 42,-
- Stand to elevate display device, height of stand approx. 480 mm, for models with weighing plate size B, KERN DE-A10, € 140,- for models with weighing plate size C, KERN DS-A03, € 140,-
- External data interface RS-232, Interface cable included, KERN YKUP-01, € 68,-
- External data interface USB, Interface cable included, KERN YKUP-03, € 98,-
- Extension-Box, KERN YKUP-13, € 98,-
- Set for underfloor weighing, consists of platform, bow, hook, only for models with weighing plate B, KERN DS-A01, € 230,-
- Further details, plenty of further accessories and suitable printers see *Accessories*

STANDARD

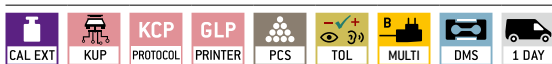

OPTION

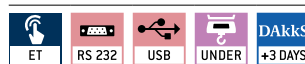

Model	Weighing capacity [Max] kg	Readability [d] g	Smallest part weight [Normal] g/piece	Counting resolution Points	Net weight approx. kg	Cable length approx. m	Weighing plate	Price excl. of VAT ex works €	Option DAKkS Calibr. Certificate	
									DAKkS KERN	€
KERN CDS 4K0.02	4	0,02	0,2	200.000	6	2	A	640,-	963-127	93,-
KERN CDS 15K0.05	15	0,05	0,5	300.000	8	2	B	600,-	963-128	112,-
KERN CDS 16K0.1	16	0,1	1	160.000	8	2	B	600,-	963-128	112,-
KERN CDS 30K0.1	30	0,1	1	300.000	8	2	B	670,-	963-128	112,-
KERN CDS 30K0.1L	30	0,1	1	300.000	10	0,6	C	1080,-	963-128	112,-
KERN CDS 36K0.2L	36	0,2	2	180.000	10	0,6	C	1070,-	963-128	112,-
KERN CDS 60K0.2	60	0,2	2	300.000	10	0,6	C	1070,-	963-129	139,-



High-resolution counting system with EC type approval to count the smallest parts in large quantities, maximum number of parts which can be displayed is 999,999

Features

- The highly accurate KERN CCA counting system can replace a whole range of individual balances, efficiently and at a reasonable price
- Thanks to EC type approval, it is also suitable for use in verified applications
- The balances are connected to one another with an RS-232 Y-cable, which also allows you to connect a printer

Reference scale KERN EWJ

- This precision balance, which can be used as an individual balance, also fulfils the highest demands through connection with a high-capacity weighing bridge
- Easy to use: All primary functions have their own key on the keypad
- Automatic internal adjustment, time-controlled every 2 h, guarantees high degree of accuracy and makes the balance independent of its location
- Draught shield standard for models with [Max] = 600 g, weighing space W×D×H 134×128×80 mm
- Protective working cover included with delivery

Quantity scale KERN IFS

- The high-accuracy quantity counting takes place on the weighing platform (= weighing bridge) IFS. In this way even the smallest of parts can be counted in large volumes
- Tough industry standard suitable for use in harsh industrial applications
- Ergonomic display device with large keypad and high-contrast LCD display for easy entry and reading of, e.g., tare weights, reference weights, limit values etc.
- Three displays for weight display, reference weight, total pieces
- 100 item memories for master data such as reference weight, reference quantity, container weight (PRE-TARE) etc.
- Precise counting: The manual reference weight optimisation gradually improves the average value of the piece weight
- Totalising of pieces when counting
- Printout with date and time
- Aluminium singlepoint load cell (1×3000 e), protection against dust and water splashes IP65
- Protective working cover included with delivery

Counting system KERN CCA

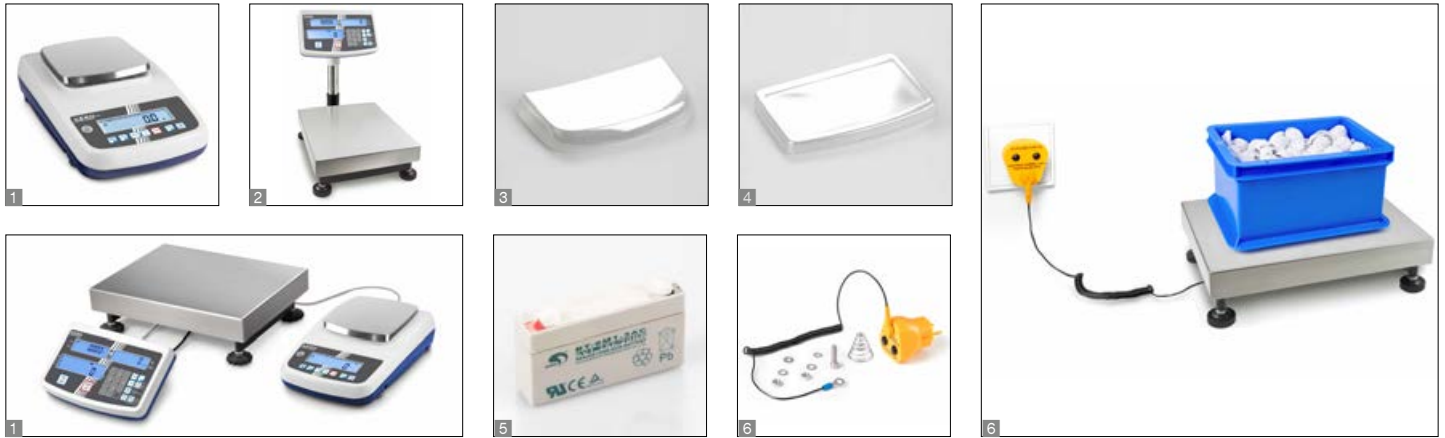

Technical data

Reference scale KERN EWJ

- Dimensions weighing surface, stainless steel [Max] 600 g: \varnothing 120 mm, see larger picture
 - 1 [Max] 6000 g: WxD 155x145 mm
- Overall dimensions WxDxH [Max] 600 g: 220x340x180 mm (incl. draught shield) [Max] 6000 g: 215x330x105 mm
- Net weight [Max] 600 g: approx. 3,2 kg [Max] 6000 g: approx. 3,4 kg

Quantity scale KERN IFS

- Dimensions weighing surface, stainless steel
 - A WxDxH 300x240x110 mm
 - B WxDxH 400x300x120 mm
 - C WxDxH 500x400x140 mm
 - D WxDxH 650x500x140 mm
- Cable length of display device approx. 3 m

Counting system KERN CCA

- Connection cable approx. 1,5 m
- Net weight
 - A approx. 9 kg
 - B approx. 14 kg
 - C approx. 16 kg
 - D approx. 24 kg

Accessories

Reference scale KERN EWJ

- 3 Protective working cover, scope of delivery 5 items, KERN EWJ-A04S05, **€ 44,-**
- 5 Internal rechargeable battery pack, operating time up to 20 h without backlight, charging time approx. 12 h, KERN KFB-A01, **€ 40,-**

Quantity scale KERN IFS

- 4 Protective working cover, scope of delivery 5 items, KERN KFB-A02S05, **€ 44,-**
- 5 Internal rechargeable battery pack, operating time up to 18 h without backlight, charging time approx. 12 h, KERN KFB-A01, **€ 40,-**
- 6 ESD drain to protect against electrostatic discharge e.g. for electrostatically-charged weighing objects or people who work with the scale, KERN YGR-01, **€ 65,-**
- 2 Stand to elevate display device Height of stand approx. 330 mm, KERN IFB-A01, **€ 68,-**
For models with weighing plate size A, B: Height of stand approx. 600 mm, KERN IFB-A02, **€ 81,-**
- Further details, plenty of further accessories and suitable printers see *Accessories*

Note: Official verification is mandatory for commercial trade

STANDARD

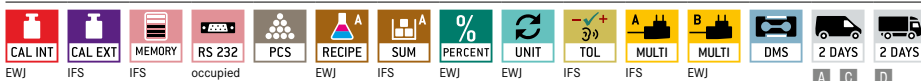

OPTION



FACTORY

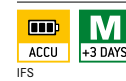

Model	Weighing capacity Quantity scale [Max] kg	Readability Quantity scale [d] g	Weighing plate	Weighing capacity Reference scale [Max] g	Readability Reference scale [d] g	Smallest part weight [Normal] g/piece	Price excl. of VAT ex works €	Verification KERN	Option DAkkS Calibr. Certificate DAkkS KERN	€	€
-------	--	---	-------------------	--	--	--	--	----------------------	--	---	---

Note: For applications that require verification, please order verification at the same time, initial verification at a later date is not possible.

Verification at the factory, we need to know the full address of the location of use.

CCA 6K-5M	3 6	1 2	A	600	0,01	0,2	1090,-	965-228-216	138,-	963-128-127	205,-
CCA 6K-4M	3 6	1 2	A	6000	0,1	1	1050,-	965-229-216	181,-	963-129-127	225,-
CCA 10K-5M	6 15	2 5	A	600	0,01	0,2	1090,-	965-228-216	138,-	963-128-127	205,-
CCA 10K-4M	6 15	2 5	A	6000	0,1	1	1050,-	965-229-216	181,-	963-129-127	225,-
CCA 30K-5M	15 30	5 10	B	600	0,01	0,2	1190,-	965-228-216	138,-	963-128-127	205,-
CCA 30K-4M	15 30	5 10	B	6000	0,1	1	1150,-	965-229-216	181,-	963-129-127	225,-
CCA 60K-5M	30 60	10 20	B	600	0,01	0,2	1200,-	965-229-216	181,-	963-129-127	225,-
CCA 60K-4M	30 60	10 20	B	6000	0,1	1	1150,-	965-229-216	181,-	963-129-127	225,-
CCA 100K-5M	60 150	20 50	C	600	0,01	0,2	1350,-	965-229-216	181,-	963-129-127	225,-
CCA 100K-4M	60 150	20 50	C	6000	0,1	1	1300,-	965-229-216	181,-	963-129-127	225,-
CCA 300K-5M	150 300	50 100	D	600	0,01	0,2	1620,-	965-229-216	181,-	963-129-127	225,-
CCA 300K-4M	150 300	50 100	D	6000	0,1	1	1610,-	965-229-216	181,-	963-129-127	225,-



Counting system to count the smallest parts in large quantities, maximum number of parts which can be displayed is 999,999

09

Features

- The highly accurate KERN CCS counting system can replace a whole range of individual balances, efficiently and at a reasonable price

Reference scale KERN CFS

- This professional counting scale, which can also be used as a stand-alone scale, meets the highest demands for accuracy, weighing capacity and volume of items, by being connected to a high-capacity weighing bridge
- Programmable using numerical key pad:
 - required reference quantity
 - known reference weight
- Three displays for weight display, reference weight, total pieces
- Memory (PLU) for 100 items with additional text, reference weight and tare weight, e.g. of a container
- Fill-to-target function: Target count or target weight can be programmed. When the target weight is reached there is an audible and visual signal
- Precise counting: The automatic reference weight optimisation of reference weight gradually improves the average piece weight value
- Draught shield standard for models with [d] = 0,001 g, weighing space W×D×H 155×141×80 mm
- Protective working cover included with delivery

Quantity scale KERN KFP/KERN KFU/ KERN KIP

- The high-accuracy quantity counting takes place on the weighing platform (= weighing bridge) . In this way even the smallest of parts can be counted in large volumes

Stainless steel platform KERN KFP-V20 IP65

- Weighing plate stainless steel, painted steel base
- Aluminium singlepoint load cell, protection against dust and water splashes
- for models with weighing plate size **A** - **E**

Weighing bridge KERN KFP-V20 IP67

- Weighing bridge made of non-slip corrugated steel plate, lacquered
- 4 load cells, alloy steel, silicone-coated, IP67
- for models with weighing plate size **F**

U-shaped weighing bridge KERN KFU-V20

- Load range: painted steel
- 4 load cells, alloy steel, silicone-coated, IP67
- for models with weighing plate size **G**

Weighing bridge KERN KIP-V20M IP67

- Lacquered steel weighing bridge, weighing plate size 1500×1500×130 mm corrugated steel plate. Extremely resistant to bending due to material thickness
- 4 load cells, alloy steel, silicone-coated, IP67
- for models with weighing plate size **H**, **I**, **J**



Technical data

Reference scale KERN CFS

- Weighing plate dimensions, stainless steel
 - 1 [d] = 0,001 g: ø 80 mm
 - [d] ≥ 0,01 g: W×D 295×225 mm
- Overall dimensions W×D×H 315×350×100 mm
- Net weight
 - [d] = 0,001 g: approx. 2,6 kg
 - [d] ≥ 0,01 g: approx. 3,4 kg

Quantity platforms, KERN KFP-V20 IP65

- Weighing plate dimensions, stainless steel
 - A W×D×H 230×230×100 mm
 - B W×D×H 300×240×110 mm
 - C W×D×H 400×300×120 mm
 - D W×D×H 500×400×137 mm
 - E W×D×H 650×500×142 mm

Bulk weighing bridges, KFP-V20 IP67

- Weighing plate dimensions, coated metal
 - F W×D×H 1500×1250×80 mm

Bulk pallet load handling, KERN KFU-V20

- Weighing plate dimensions, coated metal
 - G W×D×H 840×1190×90 mm

Quantity platforms, KERN KIP-V20M

- Weighing plate dimensions, coated metal
 - H W×D×H 1000×1000×108 mm
 - I W×D×H 1200×1500×108 mm
 - J W×D×H 1500×1500×108 mm
- Connection cable approx.
 - A–E 1,5 m
 - F–J 1,5 m

Accessories

- Protective working cover, scope of delivery 5 items, KERN CFS-A02S05, € 44,-
- 2 ESD drain to protect against electrostatic discharge e.g. for electrostatically-charged weighing objects or people who work with the scale, KERN YGR-01, € 65,-
- 3 Internal rechargeable battery pack, operating time up to 70 h without backlight, charging time approx. 14 h, KERN GAB-A04, € 42,-
- 4 Signal lamp for visual support of weighing with tolerance range, KERN CFS-A03, € 330,-
- 5 Y-cable for parallel connection of two terminal devices to the RS-232 interface on the scale, e.g. signal lamp and printer, KERN CFS-A04, € 38,-
- Further details, plenty of further accessories and suitable printers see *Accessories*

STANDARD

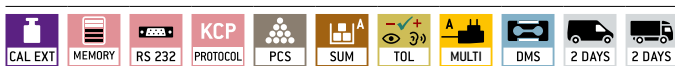

OPTION

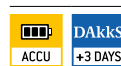

Model	Weighing capacity Quantity scale [Max] kg	Readability Quantity scale [d] g	Weighing plate	Weighing capacity Reference scale [Max] g	Readability Reference scale [d] g	Counting resolution Points	Smallest part weight [Normal] g/piece	Price excl. of VAT ex works €	Option DAkkS Calibr. Certificate DAkkS KERN	€
KERN CCS 6K-6	6	0,2	A	300	0,001	1.200.000	0,05	710,-	962-128-127	205,-
KERN CCS 10K-6	15	0,5	B	300	0,001	3.000.000	0,05	790,-	962-128-127	205,-
KERN CCS 30K0.01	30	1	C	3000	0,01	600.000	0,5	780,-	962-128-127	205,-
KERN CCS 30K0.1	30	1	C	6000	0,1	300.000	1	720,-	962-128-128	220,-
KERN CCS 60K0.01	60	2	C	3000	0,01	1.200.000	0,5	770,-	962-129-127	225,-
KERN CCS 60K0.01L	60	2	D	3000	0,01	1.200.000	0,5	820,-	962-129-127	225,-
KERN CCS 60K0.1	60	2	C	6000	0,1	600.000	1	780,-	962-129-128	250,-
KERN CCS 60K0.1L	60	2	D	6000	0,1	600.000	1	870,-	962-129-128	250,-
KERN CCS 150K0.01	150	5	D	3000	0,01	3.000.000	0,5	900,-	962-129-127	225,-
KERN CCS 150K0.01L	150	5	E	3000	0,01	3.000.000	0,5	1130,-	962-129-127	225,-
KERN CCS 150K0.1	150	5	D	6000	0,1	1.500.000	1	810,-	962-129-128	250,-
KERN CCS 150K0.1L	150	5	E	6000	0,1	1.500.000	1	1145,-	962-129-128	250,-
KERN CCS 300K0.01	300	10	E	3000	0,01	6.000.000	0,5	1220,-	962-129-127	225,-
KERN CCS 300K0.1	300	10	E	6000	0,1	3.000.000	1	1160,-	962-129-128	250,-
KERN CCS 600K-2U*	600	200	G	3000	0,01	12.000.000	0,5	2040,-	962-130-127	290,-
KERN CCS 600K-2L	600	200	F	3000	0,01	12.000.000	0,5	2950,-	962-130-127	290,-
KERN CCS 600K-1S	600	200	H	6000	0,1	6.000.000	1	1890,-	962-130-127	290,-
KERN CCS 600K-1	600	200	I	6000	0,1	6.000.000	1	2350,-	962-130-127	290,-
KERN CCS 1T-1U	1500	500	G	6000	0,1	15.000.000	1	1940,-	962-130-128	305,-
KERN CCS 1T-4S	1500	500	H	6000	0,1	15.000.000	1	1890,-	962-130-128	305,-
KERN CCS 1T-4	1500	500	I	6000	0,1	15.000.000	1	2350,-	962-130-128	305,-
KERN CCS 1T-1L	1500	500	F	6000	0,1	15.000.000	1	2900,-	962-130-128	305,-
KERN CCS 3T-1*	3000	1000	F	6000	0,1	30.000.000	1	2900,-	962-132-128	620,-
KERN CCS 3T-3	3000	1000	I	6000	0,1	30.000.000	1	2350,-	962-132-128	620,-
KERN CCS 3T-3L	3000	1000	J	6000	0,1	30.000.000	1	2690,-	962-132-128	620,-

* ONLY WHILE STOCKS LAST

VERSATILE PRODUCTS

You will always find the right model for your application in our wide range of platform scales

KERN platform scales – as versatile as your areas of use:

- Entry-level models – portable, economical and well-made – for weighing post and packages
- High-quality models – with high IP rating or with EC type approval for commercial trade
- Top models – perfect in your workflow with KERN EasyTouch software, as a user-friendly solution for complex recipe weighing or checkweighing applications with relay control and much more



True allrounders – suitable for entry-level users and industrial professionals

In order to fulfil the diverse requirements of our industrial customers, KERN platform scales have a large number of practical features, such as, for example, counting and recipe functions, data interfaces (RS 232, RS 485, USB, Bluetooth, WLAN, Ethernet), options for integration into networks, PC or printer connections, rechargeable battery/battery operation for mobile use and much more.

KERN platform scales – just true allrounders!

Note: The “Hold function” is particularly useful for industrial weighing and guarantees stable weights even when the location is unstable or when weighing animals.



THE UNBEATABLE BENEFITS OF PLATFORM SCALES:

- Weighing range from 3 kg - 600 kg
- Robust platform construction for the harshest industrial use
- Versatile, available with column
- High degree of overload protection
- Stainless steel weighing plate, shock proof and easy to clean
- Large selection of platform sizes
- Display device can be positioned separately, e.g. wall-mounted, on a column or next to the platform. Clear view for the user of the display even with bulky items on the scale.

→ Top tip:

If you can't find what you are looking for in our standard range, then we can offer you our CUSOS service: Perfect weighing solutions with personalised platform sizes, specific software solutions and adapted peripheral devices. For further information on this, see page 138/139

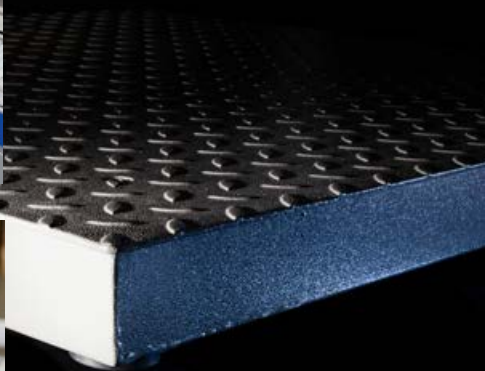

You can find a large selection of platform scales and practical accessories, such as, for example, columns, scanners etc. from page 94 or in our online shop.



The very best in user-friendliness

Through the wireless communication between the platform and display device (PC or laptop), which has the KERN EasyTouch software installed, you have the highest level of flexibility: Weighing at the location of installation and readout from up to 20 m away thanks to Bluetooth or WiFi.

10 PARCEL SCALES/ PLATFORM SCALES

Here you'll find a complete summary of the KERN platform scales series and their positioning within the platform scales segment on the basis of application, price-performance ratio and functional volume.

Precision Platform Scales

	★★★★
DS	★★★
	★

STAINLESS STEEL PLATFORM SCALES

▶ Page 71	SXS	▶ Page 72	★★★★
SFB			★★★
			★

PLATFORM SCALES WITH STAINLESS STEEL DISPLAY

	IXS	★★★★
SFE		★★★
		★

INDUSTRIAL PLATFORM SCALES

	IOC	IFS	★★★★
EOC	IFB		★★★
		▶ Page 86	★

PARCEL SCALES

	EOB	EOS	DE	★★★★
EOE				★★★
				★

Quick-Finder Parcel scales/Platform scales

Readability [d] g	Weighing capacity [Max] kg	Weighing plate W×D×H mm	Model KERN	Price excl. of VAT ex works €	Page											
						For an explanation on the pictos, see front flap										
0,01	3	228×228×95	DS 3K0.01S	710,-	107	1	●	○	●	●	○	○	○	○	○	○
0,05	8	308×318×75	DS 8K0.05	610,-	107	1	●	○	●	●	○	○	○	○	○	○
0,1	3	230×230×110	IFB 3K-4	480,-	106	1	●	○	●	●	○	○	○	○	○	○
0,1	10	228×228×95	DS 10K0.1S	600,-	107	1	●	○	●	●	○	○	○	○	○	○
0,1	16	308×318×75	DS 16K0.1	620,-	107	1	●	○	●	●	○	○	○	○	○	○
0,1	30	308×318×75	DS 30K0.1	680,-	107	1	●	○	●	●	○	○	○	○	○	○
0,1	30	500×400×125	DS 30K0.1L	1070,-	107	1	●	○	●	●	○	○	○	○	○	○
0,1 0,2	3 6	300×300×110	IOC 6K-4	420,-	104	1	●	○	●	●	○	○	○	○	○	○
0,2	6	300×240×110	IFB 6K-4	440,-	106	1	●	○	●	●	○	○	○	○	○	○
0,2	6	230×230×110	IFB 6K-4S	490,-	106	1	●	○	●	●	○	○	○	○	○	○
0,2	6	300×240×86	IXS 6K-4	790,-	109	1	●	○	●	●	○	○	○	○	○	○
0,2	36	308×318×75	DS 36K0.2	620,-	107	1	●	○	●	●	○	○	○	○	○	○
0,2	60	500×400×125	DS 60K0.2	1070,-	107	1	●	○	●	●	○	○	○	○	○	○
0,2	60	500×400×125	DS 65K0.5	1020,-	107	1	●	○	●	●	○	○	○	○	○	○
0,2 0,5	6 15	318×308×88	DE 15K0.2D	390,-	100	1	●	○	●	●	○	○	○	○	○	○
0,2 0,5	6 15	300×300×110	EOC 10K-4	390,-	102	1	●	○	●	●	○	○	○	○	○	○
0,2 0,5	6 15	300×240×110	IOC 10K-4	410,-	104	1	●	○	●	●	○	○	○	○	○	○
0,2 0,5	6 15	400×300×110	IOC 10K-4L	440,-	104	1	●	○	●	●	○	○	○	○	○	○
0,5	6	318×308×75	DE 6K0.5A	260,-	100	1	●	○	●	●	○	○	○	○	○	○
0,5	6	300×300×110	EOC 6K-4A	390,-	102	1	●	○	●	●	○	○	○	○	○	○
0,5	15	300×240×110	IFB 10K-4	445,-	106	1	●	○	●	●	○	○	○	○	○	○
0,5	15	400×300×128	IFB 10K-4L	525,-	106	1	●	○	●	●	○	○	○	○	○	○
0,5	15	300×240×86	IXS 10K-4	790,-	109	1	●	○	●	●	○	○	○	○	○	○
0,5	15	400×300×89	IXS 10K-4L	860,-	109	1	●	○	●	●	○	○	○	○	○	○
0,5	100	500×400×125	DS 100K0.5	1140,-	107	1	●	○	●	●	○	○	○	○	○	○
0,5 1	15 35	318×308×88	DE 35K0.5D	390,-	100	1	●	○	●	●	○	○	○	○	○	○
0,5 1	15 35	300×300×110	EOC 30K-4S	390,-	102	1	●	○	●	●	○	○	○	○	○	○
0,5 1	15 35	500×400×120	EOC 30K-4	445,-	102	1	●	○	●	●	○	○	○	○	○	○
0,5 1	15 30	400×300×110	IOC 30K-4	440,-	104	1	●	○	●	●	○	○	○	○	○	○
1	12	318×308×75	DE 12K1A	260,-	100	1	●	○	●	●	○	○	○	○	○	○
1	12	300×300×110	EOC 10K-3A	400,-	102	1	●	○	●	●	○	○	○	○	○	○
1	30	400×300×128	IFB 30K-3	500,-	106	1	●	○	●	●	○	○	○	○	○	○
1	30	400×300×89	IXS 30K-3	860,-	109	1	●	○	●	●	○	○	○	○	○	○
1	30	500×400×123	IXS 30K-3L	1030,-	109	1	●	○	●	●	○	○	○	○	○	○
1	150	500×400×125	DS 150K1	1140,-	107	1	●	○	●	●	○	○	○	○	○	○
1 2	3 6	318×308×75	DE 6K1D	230,-	100	1	●	○	●	●	○	○	○	○	○	○
1 2	3 6	300×300×110	EOC 6K-3	360,-	102	1	●	○	●	●	○	○	○	○	○	○
1 2	3 6	300×300×110	IOC 6K-3M	420,-	104	1	○	○	●	●	○	○	○	○	○	○
1 2	3 6	300×240×110	IFB 6K1DM	470,-	106	1	○	○	●	●	○	○	○	○	○	○
1 2	3 6	230×230×110	IFB 6K-3SM	460,-	106	1	○	○	●	●	○	○	○	○	○	○
1 2	3 6	300×240×86	IXS 6K-3M	810,-	109	1	○	○	●	●	○	○	○	○	○	○
1 2	30 60	318×308×88	DE 60K1D	390,-	100	1	●	○	●	●	○	○	○	○	○	○
1 2	30 60	522×406×98	DE 60K1DL	530,-	100	1	●	○	●	●	○	○	○	○	○	○
1 2	30 60	300×300×110	EOC 60K-3	390,-	102	1	●	○	●	●	○	○	○	○	○	○
1 2	30 60	500×400×120	EOC 60K-3L	460,-	102	1	●	○	●	●	○	○	○	○	○	○
1 2	30 60	400×300×110	IOC 60K-3	440,-	104	1	●	○	●	●	○	○	○	○	○	○
1 2	30 60	500×400×120	IOC 60K-3L	540,-	104	1	●	○	●	●	○	○	○	○	○	○
2	6	300×240×110	SFE 6K-3NM	530,-	108	1	○	○	●	●	○	○	○	○	○	○
2	24	318×308×75	DE 24K2A	260,-	100	1	●	○	●	●	○	○	○	○	○	○
2	24	300×300×110	EOC 20K-3A	400,-	102	1	●	○	●	●	○	○	○	○	○	○
2	60	400×300×128	IFB 60K-3	500,-	106	1	●	○	●	●	○	○	○	○	○	○
2	60	500×400×130	IFB 60K-3L	690,-	106	1	●	○	●	●	○	○	○	○	○	○
2	60	400×300×89	IXS 60K-3	860,-	109	1	●	○	●	●	○	○	○	○	○	○
2	60	500×400×123	IXS 60K-3L	1030,-	109	1	●	○	●	●	○	○	○	○	○	○
2 5	6 15	318×308×75	DE 15K2D	230,-	100	1	●	○	●	●	○	○	○	○	○	○
2 5	6 12	300×300×110	EOC 10K-3	380,-	102	1	●	○	●	●	○	○	○	○	○	○
2 5	6 15	300×240×110	IOC 10K-3M	360,-	104	1	○	○	●	●	○	○	○	○	○	○
2 5	6 15	400×300×110	IOC 10K-3LM	440,-	104	1	○	○	●	●	○	○	○	○	○	○
2 5	6 15	300×240×110	IFB 15K2DM	470,-	106	1	○	○	●	●	○	○	○	○	○	○
2 5	6 15	400×300×128	IFB 15K2DLM	590,-	106	1	○	○	●	●	○	○	○	○	○	○
2 5	6 15	300×240×86	IXS 10K-3M	820,-	109	1	○	○	●	●	○	○	○	○	○	○
2 5	6 15	400×300×89	IXS 10K-3LM	910,-	109	1	○	○	●	●	○	○	○	○	○	○
2 5	60 150	318×308×88	DE 150K2D	400,-	100	1	●	○	●	●	○	○	○	○	○	○
2 5	60 150	522×406×98	DE 150K2DL	530,-	100	1	●	○	●	●	○	○	○	○	○	○
2 5	60 150	300×300×110	EOC 100K-3	390,-	102	1	●	○	●	●	○	○	○	○	○	○
2 5	60 150	500×400×120	EOC 100K-3L	500,-	102	1	●	○	●	●	○	○	○	○	○	○
2 5	60 150	500×400×120	IOC 100K-3	530,-	104	1	●	○	●	●	○	○	○	○	○	○
2 5	60 150	650×500×150	IOC 100K-3L	750,-	104	1	●	○	●	●	○	○	○	○	○	○
5	15	315×305×57	EOE 10K-3	185,-	97	1	●	○	●	●	○	○	○	○	○	○
5	15	315×305×57	EOB 15K5	200,-	98	1	●	○	●	●	○	○	○	○	○	○

* Shipment via freight forwarder. Please ask for dimensions, gross weight, shipping costs

● = standard ○ = option

Quick-Finder Parcel scales/Platform scales

Readability [d] g	Weighing capacity [Max] kg	Weighing plate W×D×H mm	Model KERN	Price excl. of VAT ex works €	Page																
						For an explanation on the pictos, see front flap															
5	15	300×240×110	SFE 10K-3NM	510,-	108	1	○	●													
5	15	400×300×130	SFE 10K-3LNM	600,-	108	1	○	●													
5	60	318×308×75	DE 60K5A	260,-	100	1															
5	60	300×300×110	EOC 60K-3A	400,-	102	1															
5	150	500×400×130	IFB 100K-3	695,-	106	1															
5	150	650×500×142	IFB 100K-3L	680,-	106	1															
5	150	500×400×123	IXS 100K-3	1020,-	109	1															
5	150	650×500×133,5	IXS 100K-3L	1250,-	109	2*															
5 10	15 35	318×308×75	DE 35K5D	230,-	100	1															
5 10	15 35	522×403×83	DE 35K5DL	375,-	100	1															
5 10	15 35	300×300×110	EOC 30K-3	390,-	102	1															
5 10	15 35	500×400×120	EOC 30K-3L	445,-	102	1															
5 10	15 30	400×300×110	IOC 30K-3M	440,-	104	1	○	●													
5 10	15 30	400×300×128	IFB 30K5DM	550,-	106	1	○	●													
5 10	15 30	400×300×89	IXS 30K-2M	910,-	109	1	○	●													
5 10	15 30	500×400×123	IXS 30K-2LM	1080,-	109	1	○	●													
5 10	150 300	522×406×98	DE 300K5DL	530,-	100	1															
5 10	150 300	500×400×120	EOC 300K-3	460,-	102	1															
5 10	150 300	650×500×150	IOC 300K-3	760,-	104	1															
10	30	300×240×110	SFE 30K-2NM	530,-	108	1	○	●													
10	35	315×305×57	EOE 30K-2	185,-	97	1															
10	35	315×305×57	EOB 35K10	200,-	98	1															
10	120	318×308×75	DE 120K10A	260,-	100	1															
10	120	500×400×120	EOC 100K-2A	455,-	102	1															
10	300	650×500×142	IFB 300K-2	970,-	106	1															
10	300	650×500×133,5	IXS 300K-2	1250,-	109	2*															
10 20	30 60	318×308×75	DE 60K10D	230,-	100	1															
10 20	30 60	522×403×83	DE 60K10DL	375,-	100	1															
10 20	30 60	300×300×110	EOC 60K-2	390,-	102	1															
10 20	30 60	500×400×120	EOC 60K-2L	445,-	102	1															
10 20	30 60	400×300×110	IOC 60K-2M	440,-	104	1	○	●													
10 20	30 60	500×400×120	IOC 60K-2LM	540,-	104	1	○	●													
10 20	30 60	400×300×128	IFB 60K10DM	550,-	106	1	○	●													
10 20	30 60	500×400×130	IFB 60K10DLM	710,-	106	1	○	●													
10 20	30 60	400×300×89	IXS 60K-2M	910,-	109	1	○	●													
10 20	30 60	500×400×123	IXS 60K-2LM	1080,-	109	1	○	●													
10 20	300 600	800×600×200	IOC 600K-2	850,-	104	1															
20	60	315×305×57	EOE 60K-2	185,-	97	1															
20	60	550×550×58	EOE 60K-2L	320,-	97	1															
20	60	315×305×57	EOB 60K20	200,-	98	1															
20	60	550×550×58	EOB 60K20L	390,-	98	1															
20	60	400×300×130	SFE 60K-2NM	590,-	108	1	○	●													
20	60	500×400×140	SFE 60K-2LNM	710,-	108	1	○	●													
20	600	800×600×200	IFB 600K-2	1280,-	106	2*															
20 50	60 150	318×308×75	DE 150K20D	230,-	100	1															
20 50	60 150	522×403×83	DE 150K20DL	375,-	100	1															
20 50	60 150	650×500×89	DE 150K20DXL	530,-	100	1															
20 50	60 150	300×300×110	EOC 100K-2	390,-	102	1															
20 50	60 150	500×400×120	EOC 100K-2L	420,-	102	1															
20 50	60 150	950×500×60	EOC 100K-2XXL	680,-	102	1															
20 50	60 150	600×500×150	EOC 100K-2XL	660,-	102	1															
20 50	60 150	500×400×120	IOC 100K-2M	530,-	104	1	○	●													
20 50	60 150	650×500×150	IOC 100K-2LM	750,-	104	1	○	●													
20 50	60 150	500×400×130	IFB 150K20DM	690,-	106	1	○	●													
20 50	60 150	650×500×142	IFB 150K20DLM	910,-	106	1	○	●													
20 50	60 150	500×400×123	IXS 100K-2M	1080,-	109	1	○	●													
20 50	60 150	650×500×133,5	IXS 100K-2LM	1260,-	109	2*	○	●													
50	150	315×305×57	EOE 100K-2	185,-	97	1															
50	150	550×550×58	EOE 150K50L	320,-	97	1															
50	150	950×500×58	EOE 150K50XL	370,-	97	1															
50	150	315×305×57	EOB 150K50	200,-	98	1															
50	150	550×550×58	EOB 150K50L	390,-	98	1															
50	150	950×500×58	EOB 150K50XL	470,-	98	1															
50	150	950×500×58	EOS 150K50XL	510,-	99	1															
50	150	400×300×130	SFE 100K-2NM	620,-	108	1	○	●													
50	150	500×400×140	SFE 100K-2LNM	690,-	108	1	○	●													
50	150	650×500×140	SFE 100K-2XLNM	980,-	108	1	○	●													
50 100	150 300	522×403×83	DE 300K50D	375,-	100	1															
50 100	150 300	650×500×95	DE 300K50DL	530,-	100	1															
50 100	150 300	500×400×120	EOC 300K-2	460,-	102	1															

* Shipment via freight forwarder. Please ask for dimensions, gross weight, shipping costs

● = standard ○ = option

Quick-Finder Parcel scales/Platform scales

Readability [d] g	Weighing capacity [Max] kg	Weighing plate W×D×H mm	Model KERN	Price excl. of VAT ex works €	Page										
For an explanation on the pictos, see front flap															
50 100	150 300	600×500×150	EOC 300K-2L	660,-	102	1		●		●	●	●	●		○
50 100	150 300	650×500×150	IOC 300K-2M	760,-	104	1	○	●	○	●	●	●	●		○
50 100	150 300	650×500×142	IFB 300K50DM	890,-	106	1	○	●		●	●	●	●		○
50 100	150 300	650×500×133,5	IXS 300K-2M	1270,-	109	2*	○	●		○		●	●		○
100	300	315×305×57	EOE 300K100	185,-	97	1		●							●
100	300	550×550×58	EOE 300K100L	320,-	97	1		●							●
100	300	950×500×58	EOE 300K100XL	370,-	97	1		●							●
100	300	315×305×57	EOB 300K100A	200,-	98	1		●							●
100	300	550×550×58	EOB 300K100L	390,-	98	1		●							●
100	300	950×500×58	EOB 300K100XL	470,-	98	1		●							●
100	300	950×500×58	EOS 300K100XL	510,-	99	1		●							●
100	300	650×500×140	SFE 300K-1LNM	960,-	108	1	○	●					●		●
100 200	300 600	800×600×200	IOC 600K-1M	850,-	104	2*	○	●	○	●	●	●	●		○
100 200	300 600	800×600×200	IFB 600K-1M	1350,-	106	2*	○	●		●	●	●	●		○

* Shipment via freight forwarder. Please ask for dimensions, gross weight, shipping costs

● = standard ○ = option



Parcel scales with big platform for fast and easy weighing in the office, production, dispatch etc.

Features

- High mobility: thanks to battery operation, compact, lightweight construction, it is suitable for the use in several locations
- Wall mount for display device, standard
- Hold function: When the weighing conditions are unstable, a stable weight is calculated determining an average value

Technical data

- Large LCD display, digit height 25 mm
- Weighing plate dimensions, steel, painted
 - A W×D×H 315×305×57 mm
 - B W×D×H 550×550×58 mm, see larger picture
 - C W×D×H 950×500×58 mm
- Dimensions of display device W×D×H 235×114×51 mm
- Optional battery operation, 4×1.5 V AA not included in scope of delivery, operating time up to 100 h
- Permissible ambient temperature 5 °C/35 °C

Accessories

- Protective working cover over the display device, scope of delivery: 5 items, KERN EOB-A04BS05, **€ 44,-**
- Stand to elevate display device, for models with weighing plate size A, Height of stand approx. 480 mm KERN EOB-A01N, **€ 70,-**
- Stand to elevate display device, height of stand approx. 1000 mm, KERN EOB-A02B, **€ 142,-**
- 1 Non-slip rubber mat, W×D×H 945×505×5 mm, KERN EOE-A01, **€ 50,-**

10

STANDARD

CAL EXT UNIT MOVE BATT MULTI DMS 1 DAY

OPTION

DAKKS +3 DAYS

Model	Weighing capacity [Max]	Readability [d]	Reproducibility	Linearity	Weighing plate	Net weight approx.	Price excl. of VAT ex works	Option DAKKS Calibr. Certificate
KERN	kg	g	g	g		kg	€	DAKKS KERN €
EOE 10K-3	15	5	5	± 10	A	4,0	185,-	963-128 112,-
EOE 30K-2	35	10	10	± 20	A	4,0	185,-	963-128 112,-
EOE 60K-2	60	20	20	± 40	A	4,0	185,-	963-129 139,-
EOE 60K-2L	60	20	20	± 40	B	14	320,-	963-129 139,-
EOE 100K-2	150	50	50	± 100	A	4,0	185,-	963-129 139,-
EOE 150K50L	150	50	50	± 100	B	14	320,-	963-129 139,-
EOE 150K50XL	150	50	50	± 100	C	18	370,-	963-129 139,-
EOE 300K100	300	100	100	± 200	A	4,0	185,-	963-129 139,-
EOE 300K100L	300	100	100	± 200	B	14	320,-	963-129 139,-
EOE 300K100XL	300	100	100	± 200	C	18	370,-	963-129 139,-



Allround parcel scale with robust stainless steel weighing plate
- also with XL platform and large weighing ranges

Features

- Weighing plate stainless steel, painted steel base
- Simple and convenient 4-key operation
- Wall mount for display device, standard
- Hold function: When the weighing conditions are unstable, a stable weight is calculated determining an average value
- Protective working cover included with delivery
- Universal external mains adapter included with delivery

Technical data

- Large LCD display, digit height 25 mm
- Weighing plate dimensions, stainless steel
 - A** W×D×H 315×305×57 mm
 - B** W×D×H 550×550×58 mm, see larger picture
 - C** W×D×H 950×500×58 mm
- Dimensions of display device W×D×H 235×114×51 mm
- Optional battery operation, 4×1.5 V AA not included in scope of delivery, operating time up to 60 h
- Permissible ambient temperature 5 °C/35 °C

Accessories

- Protective working cover over the display device, scope of delivery: 5 items, KERN EOB-A04BS05, **€ 44,-**
- **1** Stand to elevate display device, height of stand approx. 1000 mm, KERN EOB-A02B, **€ 142,-**
- **2** Stand to elevate display device, for models with weighing plate size **A**, Height of stand approx. 480 mm KERN EOB-A01N, **€ 70,-**
- **3** Non-slip rubber mat, W×D×H 945×505×5 mm, KERN EOE-A01, **€ 50,-**

10

STANDARD

CAL EXT UNIT MOVE BATT MULTI DMS 1 DAY

OPTION

DAKKS +3 DAYS

Model	Weighing capacity [Max]	Readability [d]	Reproducibility	Linearity	Weighing plate	Cable length (Spiral cable) approx.	Net weight approx.	Price excl. of VAT ex works	Option DAKKS Calibr. Certificate
KERN	kg	g	g	g		m	kg	€	DAKKS KERN €
EOB 15K5	15	5	5	± 10	A	1,8	3,8	200,-	963-128 112,-
EOB 35K10	35	10	10	± 20	A	1,8	3,8	200,-	963-128 112,-
EOB 60K20	60	20	20	± 40	A	1,8	3,8	200,-	963-129 139,-
EOB 60K20L	60	20	20	± 40	B	2,7	13	390,-	963-129 139,-
EOB 150K50	150	50	50	± 100	A	1,8	3,8	200,-	963-129 139,-
EOB 150K50L	150	50	50	± 100	B	2,7	13	390,-	963-129 139,-
EOB 150K50XL	150	50	50	± 100	C	2,7	17	470,-	963-129 139,-
EOB 300K100A	300	100	100	± 200	A	1,8	3,8	200,-	963-129 139,-
EOB 300K100L	300	100	100	± 200	B	2,7	13	390,-	963-129 139,-
EOB 300K100XL	300	100	100	± 200	C	2,7	17	470,-	963-129 139,-



Heavy duty parcel and veterinary platform scale with extra large stainless steel weighing plate

Features

- Weighing plate stainless steel, painted steel base
- Simple and convenient 4-key operation
- Wall mount for display device, standard
- Hold function: When the weighing conditions are unstable, a stable weight is calculated determining an average value
- **1** The scale can be easily transported using rollers and a handle and does not require much storage space
- Protective working cover included with delivery
- Non-slip rubber mat included with delivery
- Universal external mains adapter included with delivery

Technical data

- Large LCD display, digit height 25 mm
- Weighing plate dimensions, W×D×H 950×500×58 mm, stainless steel
- Dimensions of display device W×D×H 235×114×51 mm
- Cable length display device, spiral cable, approx. 2,7 m
- Optional battery operation, 4×1.5 V AA not included in scope of delivery, operating time up to 60 h
- Permissible ambient temperature 5 °C/35 °C

Accessories

- Protective working cover over the display device, scope of delivery: 5 items, KERN EOB-A04BS05, **€ 44,-**
- **2** Stand to elevate display device, height of stand approx. 1000 mm, KERN EOB-A02B, **€ 142,-**

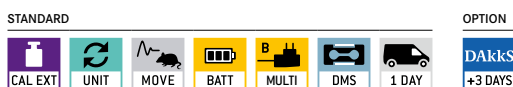

Model	Weighing capacity [Max] kg	Readability [d] g	Reproducibility g	Linearity g	Net weight approx. kg	Price excl. of VAT ex works €	Option DAKkS Calibr. Certificate DAKkS KERN €
KERN							
EOS 150K50XL	150	50	50	± 100	17	510,-	963-129 139,-
EOS 300K100XL	300	100	100	± 200	17	510,-	963-129 139,-



10

A long-term successful model with dust and spray protected display device



Piece counting



Animal weighing

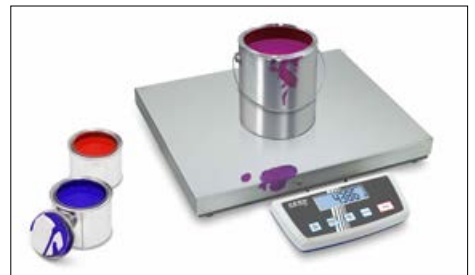

Recipe-weighing



Features

- High mobility: thanks to battery operation/ rechargeable battery operation (optional), compact, lightweight construction, it is suitable for the use in several locations (production, warehouse, dispatch department etc.)
- Display device flexible positioning e. g. free-standing or screwed to the wall
- **1** Display device: Plastics, protection against dust and water splashes IP65
- Weighing plate stainless steel, painted steel base
- PRE-TARE function for manual subtraction of a known container weight, useful for checking fill-levels
- With the recipe function you can weigh the different ingredients of a mixture. As a check, you can also call up the total weight of all the ingredients

- Freely programmable weighing unit, e.g. display direct in special units such as length of thread g/m, paper weight g/m², or similar
- Protective working cover included with delivery

Technical data

- Large backlit LCD display, digit height 25 mm
- Weighing plate dimensions, stainless steel
 - A** W×D×H 318×308×75 mm
 - B** W×D×H 318×308×88 mm
 - C** W×D×H 522×403×83 mm, see larger picture
 - D** W×D×H 522×406×98 mm
 - E** W×D×H 650×500×89 mm
- Dimensions of display device W×D×H 225×110×56 mm
- Optional battery operation, 9 V block not included in scope of delivery, operating time up to 12 h
- Permissible ambient temperature 5 °C/35 °C

Accessories

- Protective working cover over the display device, scope of delivery: 5 items, KERN DE-A12S05, **€ 44,-**
- Internal rechargeable battery pack, operating time up to 30 h without backlight, charging time approx. 10 h, KERN NDE-A02, **€ 60,-**
- Mount to fasten the display device to the platform, for models with weighing plate size **B, C**, KERN DE-A11N, **€ 42,-**
- Wall mount for display device, KERN DE-A13, **€ 32,-**
- **2** Stand to elevate display device, height of stand approx. 480 mm, KERN DE-A10, **€ 140,-**
- Individual header data: the free software SHM-01 can be used to print header lines on the printout when using printers YKN-01 and YKB-01N
- Further details, plenty of further accessories and suitable printers see *Accessories*

STANDARD

CAL EXT | RS 232 | GLP | PRINTER | PCS | SUM | PERCENT | UNIT | MOVE | IP 65 | BATT | MULTI | DMS | 1 DAY

OPTION

ACCU | DAKKS +3 DAYS

Model	Weighing capacity [Max] kg	Readability [d] g	Reproducibility g	Linearity g	Smallest part weight [Normal] g/piece	Cable length approx. m	Net weight approx. kg	Weighing plate	Price excl. of VAT ex works €	Option DAKKS Calibr. KERN	Certificate €
Multi-range balance, with increasing load it switches automatically to the next largest weighing range [Max] and readout [d] and when the load is fully removed, the balance switches back to the lower range											
DE 15K0.2D	6 15	0,2 0,5	0,2 0,5	± 0,8 2	4	1	4	B	390,-	963-128	112,-
DE 35K0.5D	15 35	0,5 1	0,5 1	± 2 4	10	1	7	B	390,-	963-128	112,-
DE 60K1D	30 60	1 2	1 2	± 4 8	20	1,47	7	B	390,-	963-129	139,-
DE 60K1DL	30 60	1 2	1 2	± 4 8	20	1,4	15	C	530,-	963-129	139,-
DE 150K2D	60 150	2 5	2 5	± 8 20	40	1,6	7	B	400,-	963-129	139,-
DE 150K2DL	60 150	2 5	2 5	± 8 20	40	1,4	15	C	530,-	963-129	139,-
DE 300K5DL	150 300	5 10	5 10	± 20 40	100	1,4	15	C	530,-	963-129	139,-
DE 6K1D	3 6	1 2	1 2	± 3 6	40	1,4	4,8	A	230,-	963-128	112,-
DE 15K2D	6 15	2 5	2 5	± 6 15	100	1,4	4,8	A	230,-	963-128	112,-
DE 35K5D	15 35	5 10	5 10	± 15 30	100	1,4	4,8	A	230,-	963-128	112,-
DE 35K5DL	15 35	5 10	5 10	± 15 30	100	1,4	16	D	375,-	963-128	112,-
DE 60K10D	30 60	10 20	10 20	± 30 60	200	1,4	4,8	A	230,-	963-129	139,-
DE 60K10DL	30 60	10 20	10 20	± 30 60	200	1,4	16	D	375,-	963-129	139,-
DE 150K20D	60 150	20 50	20 50	± 60 150	400	1,5	5	A	230,-	963-129	139,-
DE 150K20DL	60 150	20 50	20 50	± 60 150	400	1,5	16	D	375,-	963-129	139,-
DE 150K20DXL	60 150	20 50	20 50	± 60 150	400	1,4	28	E	530,-	963-129	139,-
DE 300K50D	150 300	50 100	50 100	± 150 300	2000	1,25	16	D	375,-	963-129	139,-
DE 300K50DL	150 300	50 100	50 100	± 150 300	2000	1,05	28	E	530,-	963-129	139,-
DE 6K0.5A	6	0,5	0,5	± 1,5	10	1,4	4,8	A	260,-	963-128	112,-
DE 12K1A	12	1	1	± 3	20	1,4	4,8	A	260,-	963-128	112,-
DE 24K2A	24	2	2	± 6	40	1,4	4,8	A	260,-	963-128	112,-
DE 60K5A	60	5	5	± 15	100	1,4	4,8	A	260,-	963-129	139,-
DE 120K10A	120	10	10	± 30	200	1,4	5,0	A	260,-	963-129	139,-



10

Robust and high-resolution platform scale with practical Flip/Flop display device for greatest ease of use



Weighing instead of counting! Because the counting function is so easy to use, you can rapidly record large numbers of small parts – which saves time and money

Practical Flip/Flop display device: flexible positioning e.g. free-standing or screwed to the wall (optional). By rotating the upper housing shell you can determine the angle of the display as well as the cable outlet. Factory Option for an additional cost, delivery time + 2 working days, KERN KIB-M01, see *Accessories* on the right, please indicate when placing your order



Features

- High mobility: thanks to rechargeable battery operation (optional), compact, lightweight construction, it is suitable for the use in several locations (laboratory, production, quality control, commissioning etc.)
- **1** Platform: weighing plate stainless steel, painted steel base, silicone-coated aluminium load cell, protection against dust and water splashes IP65. Level indicator and levelling feet for precise levelling of the scale, fitted as standard, to give the most accurate weighing result
- Weighing with tolerance range (checkweighing): a visual and audible signal helps with portioning, dispensing or grading
- Hold function: When the weighing conditions are unstable, a stable weight is calculated determining an average value
- Benchtop stand incl. wall mount for display device as standard
- Protective working cover included with delivery

- Searching and remote control of the balance using external control devices or computers with the KERN Communication Protocol (KCP). KCP is a standardised interface command structure for KERN balances and other instruments which allows you to recall and manage all relevant parameters and device functions. You can therefore simply connect KERN devices with KCP to computers, industrial control systems and other digital systems. In a large number of cases the KCP is compatible with the MT-SICS protocol.

Technical data

- Large backlit LCD display, digit height 25 mm
- Weighing plate dimensions, stainless steel
 - A** W×D×H 300×300×110 mm
 - B** W×D×H 500×400×120 mm, see larger picture
 - C** W×D×H 600×500×150 mm
 - D** W×D×H 950×500×60 mm
- Dimensions of display device W×D×H 268×115×80 mm
- Permissible ambient temperature -10 °C/40 °C

Accessories

- Protective working cover, scope of delivery 5 items, KERN EOC-A01S05, **€ 44,-**
- Internal rechargeable battery pack, operating time up to 43 h without backlight, charging time approx. 3 h, KERN KFB-A01, **€ 40,-**
- **2** Stand to elevate display device, height of stand approx. 330 mm, KERN EOC-A05, **€ 70,-**
- **3** Mount to fasten the display device to the platform, KERN EOC-A03, **€ 33,-**
- Benchtop stand incl. wall mount for display device, KERN EOC-A04, **€ 33,-**
- Modification of the display device, to move the cable outlet to the front of the display device, ideal e.g. for subsequent wall installation of the display device (standard configuration ex works: rear outlet), Factory Option, delivery time + 2 working days, KERN KIB-M01, **€ 104,-**

STANDARD

CAL EXT | RS 232 | KCP | GLP | PCS | SUM | % | TOL | MOVE | IP 65 | MULTI | DMS | 1 DAY

OPTION

ACCU | DAKKS | +3 DAYS

Model	Weighing capacity [Max] kg	Readability [d] g	Reproducibility g	Linearity g	Smallest part weight [Normal] g/piece	Weighing plate	Cable length approx. m	Net weight approx. kg	Price excl. of VAT ex works €	Option DAKKS	Calibr. KERN	Certificate €
Multi-range balance, with increasing load it switches automatically to the next largest weighing range [Max] and readout [d] and when the load is fully removed, the balance switches back to the lower range												
EOC 10K-4	6 15	0,2 0,5	0,2 0,5	± 0,6 1,5	5	A	3	6	390,-	963-128	112,-	
EOC 30K-4S	15 35	0,5 1	0,5 1	± 1,5 3	10	B	3	9	390,-	963-128	112,-	
EOC 30K-4	15 35	0,5 1	0,5 1	± 1,5 3	10	A	3	6	445,-	963-128	112,-	
EOC 60K-3	30 60	1 2	1 2	± 3 6	20	A	3	6	390,-	963-129	139,-	
EOC 60K-3L	30 60	1 2	1 2	± 3 6	20	B	3	9	460,-	963-129	139,-	
EOC 100K-3	60 150	2 5	2 5	± 6 15	50	A	3	6	390,-	963-129	139,-	
EOC 100K-3L	60 150	2 5	2 5	± 6 15	50	B	3	9	500,-	963-129	139,-	
EOC 300K-3	150 300	5 10	5 10	± 15 30	100	B	3	9	460,-	963-129	139,-	
EOC 6K-3	3 6	1 2	1 2	± 3 6	2,5	A	3	6	360,-	963-128	112,-	
EOC 10K-3	6 12	2 5	2 5	± 6 15	5	A	3	6	380,-	963-128	112,-	
EOC 30K-3	15 35	5 10	5 10	± 15 30	10	A	3	6	390,-	963-128	112,-	
EOC 30K-3L	15 35	5 10	5 10	± 15 30	10	B	3	9	445,-	963-128	112,-	
EOC 60K-2	30 60	10 20	10 20	± 30 60	20	A	3	6	390,-	963-129	139,-	
EOC 60K-2L	30 60	10 20	10 20	± 30 60	20	B	3	9	445,-	963-129	139,-	
EOC 100K-2	60 150	20 50	20 50	± 60 150	50	A	3	6	390,-	963-129	139,-	
EOC 100K-2L	60 150	20 50	20 50	± 60 150	50	B	3	9	420,-	963-129	139,-	
EOC 100K-2XL	60 150	20 50	20 50	± 60 150	50	C	3	19	660,-	963-129	139,-	
EOC 100K-2XXL	60 150	20 50	20 50	± 60 150	100	D	2,7	17	680,-	963-129	139,-	
EOC 300K-2	150 300	50 100	50 100	± 150 300	100	B	3	9	460,-	963-129	139,-	
EOC 300K-2L	150 300	50 100	50 100	± 150 300	100	C	3	19	660,-	963-129	139,-	
EOC 6K-4A	6	0,5	0,5	± 1,5	2,5	A	3	6	390,-	963-128	112,-	
EOC 10K-3A	12	1	1	± 3	5	A	3	6	400,-	963-128	112,-	
EOC 20K-3A	24	2	2	± 6	10	A	3	6	400,-	963-128	112,-	
EOC 60K-3A	60	5	5	± 15	20	A	3	6	400,-	963-129	139,-	
EOC 100K-2A	120	10	10	± 30	50	B	3	9	455,-	963-129	139,-	



10

Allround platform scale with a wide range of communication options and EC type approval [M] - also available as high-resolution version with fine display



Verification plug, for verified balances this enables you to separate the display device and platform without affecting the verification, e.g. for installing the scale in a packing and dispatch table, pit frame etc. at a later date. Please order this item when making the scale purchase, see *Accessory*



Practical Flip/Flop display device: flexible positioning e.g. free-standing or screwed to the wall (optional). By rotating the upper housing shell you can determine the angle of the display as well as the cable outlet.
 Factory Option for an additional cost, delivery time + 2 working days, KERN KIB-M01, see *Accessories* on the right, please indicate when placing your order

Features

- Industry 4.0: A wide range of (optional) data interfaces allows easy transfer of weighing data to tablets, laptops, PCs, networks, smartphones, printers, etc.
- Searching and remote control of the balance using external control devices or computers with the KERN Communication Protocol (KCP). KCP is a standardised interface command structure for KERN balances and other instruments which allows you to recall and manage all relevant parameters and device functions. You can therefore simply connect KERN devices with KCP to computers, industrial control systems and other digital systems. In a large number of cases the KCP is compatible with the MT-SICS protocol. Only possible through data interface RS-232, other interfaces on request, for details see page 8/9
- Standardised, simplified concept of operation
- High mobility: thanks to rechargeable battery operation (optional), compact, lightweight construction, it is suitable for the use in several locations (laboratory, production, quality control, commissioning etc.)
- Platform: weighing plate stainless steel, painted steel base, silicone-coated aluminium load cell, protection against dust and water splashes IP65
- Level indicator and levelling feet for precise levelling of the scale, fitted as standard, to give the most accurate weighing result

Technical data

- Large LCD display, digit height 25 mm
- Weighing plate dimensions, stainless steel, W×D×H×
 - 300×240×110 mm, ■ 300×300×110 mm
 - 400×300×110 mm, ■ 500×400×120 mm
 - 650×500×150 mm, ■ 800×600×200 mm
- Dimensions of display device W×D×H 268×115×80 mm
- Cable length display device approx. 3 m
- Permissible ambient temperature -10 °C/40 °C

Accessories

- Protective working cover, scope of delivery 5 items, KERN EOC-A01S05, **€ 55,-**
- Stand to elevate display device, height of stand approx. 330 mm, KERN EOC-A05, **€ 70,-**
- Mount to fasten the display device to the platform, KERN EOC-A03, **€ 33,-**
- Benchtop stand incl. wall mount for display device, KERN EOC-A04, **€ 33,-**
- Internal rechargeable battery pack, operating time up to 26 h with backlight, charging time approx. 3 h, KERN KFB-A01, **€ 40,-**
- USB data interface, for transferring weighing to the PC, printer etc., must be ordered at purchase, KERN KIB-A03, **€ 120,-**
- Bluetooth data interface for wireless data transfer to PC or tablets, must be ordered at purchase, KERN KIB-A04, **€ 110,-**
- WiFi interface for wireless connection of the balance to networks and WiFi capable devices, such as tablets, laptops or smartphones, continuous data transfer, must be ordered at purchase, KERN KIB-A10, **€ 130,-**

- Ethernet data interface, to connect an IP-based Ethernet network, continuous data transfer, must be ordered at purchase, KERN KIB-A02, **€ 165,-**
- Signal lamp, including interface, for visual support of weighing with tolerance range, must be ordered at purchase, KERN KIB-A06, **€ 470,-**
- Alibi memory, for paperless archiving of the weighing results with ID no., gross/net/tare value, date and time, must be ordered at purchase, KERN KIB-A13, **€ 164,-**
- Alibi memory, including USB interface for exporting weighing results to external data storage media, such as, for example, USB sticks, hard drives, etc., must be ordered at purchase, KERN KIB-A01, **€ 175,-**
- ■ Verification plug, for verified balances this enables you to separate the display device and platform without affecting the verification, e.g. for installing the scale in a packing and dispatch table, pit frame etc. at a later date. Please order this at the same time as you purchase your scale, KERN KIB-A12, **€ 164,-**
- Modification of the display device, to move the cable outlet to the front of the display device, ideal e.g. for subsequent wall installation of the display device (standard configuration ex works: rear outlet), Factory Option, delivery time + 2 working days, KERN KIB-M01, **€ 104,-**
- Note: In addition to the RS-232 data interface, which is integrated as standard, only one other data interface can be installed and operated

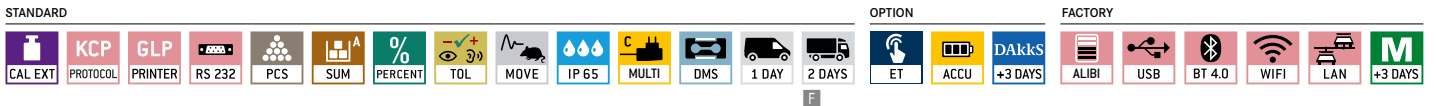

Model	Weighing capacity [Max] kg	Readability [d] g	Verification value [e] g	Minimal load [Min] g	Weighing plate	Price excl. of VAT ex works €	Option			
							Verification KERN	DAkKS €	Calibr. Certificate KERN €	
Multi-range balance, with increasing load it switches automatically to the next largest weighing range [Max] and readout [d] and when the load is fully removed, the balance switches back to the lower range										
IOC 6K-4	3 6	0,1 0,2	-	-	B	420,-	-	-	963-128	112,-
IOC 10K-4	6 15	0,2 0,5	-	-	A	410,-	-	-	963-128	112,-
IOC 10K-4L	6 15	0,2 0,5	-	-	C	440,-	-	-	963-128	112,-
IOC 30K-4	15 30	0,5 1	-	-	C	440,-	-	-	963-128	112,-
IOC 60K-3	30 60	1 2	-	-	C	440,-	-	-	963-129	139,-
IOC 60K-3L	30 60	1 2	-	-	D	540,-	-	-	963-129	139,-
IOC 100K-3	60 150	2 5	-	-	D	530,-	-	-	963-129	139,-
IOC 100K-3L	60 150	2 5	-	-	E	750,-	-	-	963-129	139,-
IOC 300K-3	150 300	5 10	-	-	E	760,-	-	-	963-129	139,-
IOC 600K-2	300 600	10 20	-	-	F	850,-	-	-	963-130	196,-

Note: For applications that require verification, please order verification at the same time, initial verification at a later date is not possible.

Verification at the factory, we need to know the full address of the location of use.

IOC 6K-3M	3 6	1 2	1 2	20 40	B	420,-	965-228	80,-	963-128	112,-
IOC 10K-3M	6 15	2 5	2 5	40 100	A	360,-	965-228	80,-	963-128	112,-
IOC 10K-3LM	6 15	2 5	2 5	40 100	C	440,-	965-228	80,-	963-128	112,-
IOC 30K-3M	15 30	5 10	5 10	100 200	C	440,-	965-228	80,-	963-128	112,-
IOC 60K-2M	30 60	10 20	10 20	200 400	C	440,-	965-229	105,-	963-129	139,-
IOC 60K-2LM	30 60	10 20	10 20	200 400	D	540,-	965-229	105,-	963-129	139,-
IOC 100K-2M	60 150	20 50	20 50	400 1000	D	530,-	965-229	105,-	963-129	139,-
IOC 100K-2LM	60 150	20 50	20 50	400 1000	E	750,-	965-229	105,-	963-129	139,-
IOC 300K-2M	150 300	50 100	50 100	1000 2000	E	760,-	965-229	105,-	963-129	139,-
IOC 600K-1M	300 600	100 200	100 200	2000 4000	F	850,-	965-230	150,-	963-130	196,-

It is essential that a verified balance which transfers measurements to external devices using an interface, has an alibi memory (KIB-A13).

It is not possible to upgrade later.



Accessories

- Protective working cover, scope of delivery 5 items, KERN KFB-A02S05, **€ 44,-**
- **2** Stand to elevate display device, for models with weighing plate size
 - A - E**: Height of stand approx. 330 mm, KERN IFB-A01, **€ 68,-**
 - D - F**: Height of stand approx. 600 mm, KERN IFB-A02, **€ 81,-**
 - A - F**: Stand to elevate display device, Height of stand approx. 800 mm, KERN BFS-A07, **€ 170,-**
- Internal rechargeable battery pack, operating time up to 35 h without backlight, charging time approx. 12 h, must be ordered at purchase, KERN KFB-A01, **€ 40,-**
- Bluetooth data interface, must be ordered at purchase, not in combination with verification, KERN KFB-A03, **€ 160,-**
- Analogue module, not possible in combination with signal lamp, must be ordered at purchase, 0-10 V, KERN KFB-A04, **€ 170,-**
4-20 mA, KERN KFB-A05, **€ 170,-**
- Signal lamp for visual support of weighing with tolerance range, KERN CFS-A03, **€ 330,-**
- Y-cable for parallel connection of two terminal devices to the RS-232 interface on the scale, e.g. signal lamp and printer, KERN CFS-A04, **€ 38,-**

High-resolution industrial scale in heavy version with EC type approval [M], now also up to [Max] 600 kg

Features

- Tough industry standard suitable for use in harsh industrial applications
- **1** Platform: weighing plate stainless steel, painted steel base, silicone-coated aluminium load cell, protection against dust and water splashes IP65
- Benchtop stand incl. wall mount for display device as standard
- Protective working cover included with delivery

Technical data

- Large backlit LCD display, digit height 52 mm
- Weighing plate dimensions, stainless steel W×D×H
 - A** 230×230×110mm, **B** 300×240×110 mm
 - C** 400×300×128 mm, **D** 500×400×130 mm
 - E** 650×500×142 mm, **F** 800×600×200 mm
- Dimensions of display device W×D×H 250×160×58 mm
- Cable length of display device approx. 3 m
- Permissible ambient temperature -10 °C/40 °C

STANDARD

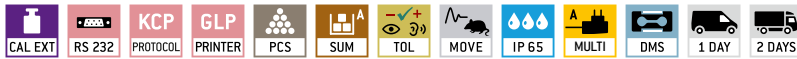

OPTION



FACTORY



Model	Weighing capacity [Max] kg	Readability [d] g	Verification value [e] g	Minimal load [Min] g	Net weight approx. kg	Weighing plate	Price excl. of VAT ex works €	Option			
								Verification KERN	DAkkS KERN	Calibr. Certificate	
KERN IFB 3K-4	3	0,1	-	-	4,6	A	480,-	-	-	963-127	93,-
IFB 6K-4S	6	0,2	-	-	4,6	A	490,-	-	-	963-128	112,-
IFB 6K-4	6	0,2	-	-	5	B	440,-	-	-	963-128	112,-
IFB 10K-4	15	0,5	-	-	5	B	445,-	-	-	963-128	112,-
IFB 10K-4L	15	0,5	-	-	8	C	525,-	-	-	963-128	112,-
IFB 30K-3	30	1	-	-	8	C	500,-	-	-	963-128	112,-
IFB 60K-3	60	2	-	-	8	C	500,-	-	-	963-129	139,-
IFB 60K-3L	60	2	-	-	11	D	690,-	-	-	963-129	139,-
IFB 100K-3	150	5	-	-	11	D	695,-	-	-	963-129	139,-
IFB 100K-3L	150	5	-	-	20	E	680,-	-	-	963-129	139,-
IFB 300K-2	300	10	-	-	20	E	970,-	-	-	963-129	139,-
IFB 600K-2	600	20	-	-	44	F	1280,-	-	-	963-130	196,-

Multi-range balance, with increasing load it switches automatically to the next largest weighing range [Max] and readout [d] and when the load is fully removed, the balance switches back to the lower range

IFB 6K-3SM	3 6	1 2	1 2	20 40	4,6	A	460,-	965-228	80,-	963-128	112,-
IFB 6K1DM	3 6	1 2	1 2	20 40	5	B	470,-	965-228	80,-	963-128	112,-
IFB 15K2DM	6 15	2 5	2 5	40 100	5	B	470,-	965-228	80,-	963-128	112,-
IFB 15K2DLM	6 15	2 5	2 5	40 100	8	C	590,-	965-228	80,-	963-128	112,-
IFB 30K5DM	15 30	5 10	5 10	100 200	8	C	550,-	965-228	80,-	963-128	112,-
IFB 60K10DM	30 60	10 20	10 20	200 400	8	C	550,-	965-229	105,-	963-129	139,-
IFB 60K10DLM	30 60	10 20	10 20	200 400	11	D	710,-	965-229	105,-	963-129	139,-
IFB 150K20DM	60 150	20 50	20 50	400 1000	11	D	690,-	965-229	105,-	963-129	139,-
IFB 150K20DLM	60 150	20 50	20 50	400 1000	20	E	910,-	965-229	105,-	963-129	139,-
IFB 300K50DM	150 300	50 100	50 100	1000 2000	20	E	890,-	965-229	105,-	963-129	139,-
IFB 600K-1M	300 600	100 200	100 200	2000 4000	44	F	1350,-	965-230	150,-	963-130	196,-

Note: For applications that require verification, please order verification at the same time, initial verification at a later date is not possible.

Verification at the factory, we need to know the full address of the location of use.



Precision industrial scale with laboratory accuracy, ideal for the various possibilities of Industrie 4.0 applications

Features

- High-capacity precision balance, ideal for high volume or heavy samples to be weighed with a high degree of accuracy
- User guidance step by step on display by Yes/No dialogue
- Numerical subtraction of tare weight for known container weight. Useful for checking fill-levels
- Precise counting: The automatic reference weight optimisation of reference weight gradually improves the average piece weight value
- Freely programmable weighing unit, e.g. display direct in special units such as length of wire g/m, surface weight g/m², or else
- KERN Universal Port (KUP): permits the connection of an external KUP interface adapter, such as, for example, RS-232, USB, Bluetooth or Ethernet, for the exchange of data and control commands, without any installation outlay, for details see page 8/9

- KERN Communication Protocol (KCP): The KCP permits searching and remote control of the balance using external control devices or computers
- Standardised, simplified concept of operation
- Protective working cover included with delivery

Technical data

- Large backlit LCD display, digit height 21 mm
- Weighing plate dimensions, stainless steel
 - A** W×D×H 228×228×95 mm
 - B** W×D×H 308×318×75 mm
 - C** W×D×H 500×400×125 mm, see larger picture
- Dimensions of display device W×D×H 225×115×60 mm
- Permissible ambient temperature -10 °C/40 °C

Accessories

- Protective working cover over the display device, scope of delivery: 5 items, KERN DE-A12S05, **€ 44,-**
- **1** Stand to elevate display device, height of stand approx. 480 mm, for models with weighing plate size **A**, **B**, KERN DE-A10, **€ 140,-** for models with weighing plate size **C**, KERN DS-A03, **€ 140,-**
- Mount to fasten the display device to the platform, for models with weighing plate size **B**, **C**, KERN DE-A11N, **€ 42,-**
- Wall mount for display device, KERN DS-A02, **€ 33,-**
- **2** Set for underfloor weighing, consists of platform, bow, hook, only for models with weighing plate **B**, KERN DS-A01, **€ 230,-**
- External data interface RS-232, Interface cable included, KERN YKUP-01, **€ 68,-**
- External data interface USB, Interface cable included, KERN YKUP-03, **€ 98,-**
- Extension-Box, KERN YKUP-13, **€ 98,-**
- Further details, plenty of further accessories and suitable printers see Accessories

STANDARD



OPTION

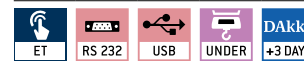

Model	Weighing capacity [Max] kg	Readability [d] g	Smallest part weight [Normal] g/piece	Cable length of display device m	Net weight approx. kg	Resolution Points	Weighing plate	Price excl. of VAT ex works €	Option	
									DAKKS	Calibr. Certificate
KERN								€	KERN	€
DS 3K0.01S	3	0,01	0,1	2	4,2	300.000	A	710,-	963-127	93,-
DS 5K0.05S	5	0,05	0,1	2	4,2	100.000	A	620,-	963-127	93,-
DS 8K0.05	8	0,05	0,5	2	8	160.000	B	610,-	963-128	112,-
DS 10K0.1S	10	0,1	1	2	4,2	100.000	A	600,-	963-128	112,-
DS 16K0.1	16	0,1	1	2	8	160.000	B	620,-	963-128	112,-
DS 20K0.1	20	0,1	1	2	8	200.000	A	640,-	963-128	112,-
DS 30K0.1	30	0,1	1	2	8	300.000	B	680,-	963-128	112,-
DS 30K0.1L	30	0,1	1	0,6	10	300.000	C	1070,-	963-128	112,-
DS 36K0.2	36	0,2	1	0,6	10	180.000	B	620,-	963-128	112,-
DS 36K0.2L	36	0,2	1	0,6	10	180.000	C	1000,-	963-128	112,-
DS 60K0.2	60	0,2	2	0,6	10	300.000	C	1070,-	963-129	139,-
DS 65K0.5	60	0,2	2	0,6	10	300.000	C	1020,-	963-129	139,-
DS 100K0.5	100	0,5	5	0,6	10	200.000	C	1140,-	963-129	139,-
DS 150K1	150	1	10	0,6	10	150.000	C	1140,-	963-129	139,-



Platform scale with dust and spray protection IP65 and EC type approval [M]

Features

- Platform scale protected to IP65 with stainless steel display device, for industrial applications, hygienic and easy to clean
- 1** Platform: weighing plate stainless steel, painted steel base, silicone-coated aluminium load cell, protection against dust and water splashes IP65
- Display device: Stainless steel, protection against dust and water splashes IP65, flexible positioning, e.g. free-standing or mounted to the wall, for details see KERN KFE-TM
- Weighing with tolerance range (checkweighing): a visual and audible signal helps with portioning, dispensing or grading
- Hold function: When the weighing conditions are unstable, a stable weight is calculated determining an average value

- PRE-TARE function for manual subtraction of a known container weight, useful for checking fill-levels (only for non-verified models)

Technical data

- Large backlit LCD display, digit height 22 mm
- Weighing plate dimensions, stainless steel
 - A** W×D×H 300×240×110 mm, see larger picture
 - B** W×D×H 400×300×130 mm
 - C** W×D×H 500×400×140 mm
 - D** W×D×H 650×500×140 mm
- Dimensions of display device W×D×H 195×120×70 mm
- Rechargeable battery pack integrated, as standard, operating time up to 35 h without backlight, charging time approx. 12 h
- Cable length of display device approx. 3 m
- Permissible ambient temperature -10 °C/40 °C

Accessories

- Stand to elevate display device, for models with weighing plate size
 - A - D**: Height of stand approx. 200 mm, KERN SFE-A01, € 75,- **2**
 - B - D**: Height of stand approx. 400 mm, KERN SFE-A02, € 75,- **2**
 - C - D**: Height of stand approx. 600 mm, KERN SFE-A03, € 95,- **3**
- Tare pan made from stainless steel, overall dimensions W×D×H, 400×300×45 mm, KERN RFS-A02, € 75,-

STANDARD



OPTION



FACTORY



Model	Weighing capacity [Max] kg	Readability [d] g	Verification value [e] g	Minimal load [Min] g	Net weight approx. kg	Weighing plate	Price excl. of VAT ex works €	Option			
								Verification KERN	€	DAKKS Calibr. Certificate DAKKS KERN	€
SFE 6K-3NM	6	2	2	40	6	A	530,-	965-228	80,-	963-128	112,-
SFE 10K-3NM	15	5	5	100	6	A	510,-	965-228	80,-	963-128	112,-
SFE 10K-3LNM	15	5	5	100	8	B	600,-	965-228	80,-	963-128	112,-
SFE 30K-2NM	30	10	10	200	6	A	530,-	965-228	80,-	963-128	112,-
SFE 60K-2NM	60	20	20	400	8	B	590,-	965-229	105,-	963-129	139,-
SFE 60K-2LNM	60	20	20	400	12	C	710,-	965-229	105,-	963-129	139,-
SFE 100K-2NM	150	50	50	1000	8	B	620,-	965-229	105,-	963-129	139,-
SFE 100K-2LNM	150	50	50	1000	12	C	690,-	965-229	105,-	963-129	139,-
SFE 100K-2XLNM	150	50	50	1000	22	D	980,-	965-229	105,-	963-129	139,-
SFE 300K-1LNM	300	100	100	2000	22	D	960,-	965-229	105,-	963-129	139,-

Note: For applications that require verification, please order verification at the same time, initial verification at a later date is not possible.

Verification at the factory, we need to know the full address of the location of use.



10

Platform scale with stainless steel display device with IP68 rating, XL-display und EC type approval [M] – now also as high resolution version with high-resolution display



Piece-counting function



Durable stainless steel weighing plate



Stainless steel display device with protection IP68, hygienic and easy to clean

Platform scale with stainless steel display device KERN IXS



Features

- Tough industry standard suitable for use in harsh industrial applications
- **1** Platform: weighing plate stainless steel, painted steel base, silicone-coated aluminium load cell, protection against dust and water splashes IP65, Substruction in wing design, extremely resistant to bending
- Superior display size: digit height 55 mm, bright backlight for easy reading of weighing results, even in poor lighting conditions
- **2** Display device: Stainless steel, protection against dust and water splashes IP68, integrated power supply
- ESD drain to protect against electrostatic discharge e.g. for electrostatically-charged weighing objects or people who work with the scale
- Thanks to interfaces such as RS-232, RS-485 and Bluetooth (optional) the scale can easily be connected to existing networks and facilitates the data exchange between the scale and printer[^]

Technical data

- Large backlit LCD display, digit height 55 mm
- Weighing plate dimensions, stainless steel W×D×H
 - A** 300×240×86 mm, **B** 400×300×89 mm
 - C** 500×400×123 mm, **D** 650×500×133,5 mm
- Dimensions of display device W×D×H 232×150×80 mm
- Cable length of display device approx. 3 m
- Permissible ambient temperature -10 °C/40 °C

Accessories

- **B** Stand to elevate display device
 - A-D** Height of stand approx. 50 mm, KERN IXS-A01, **€ 93,-**
 - A-D** Height of stand approx. 200 mm, KERN IXS-A02, **€ 118,-**
 - B-D** Height of stand approx. 400 mm, KERN IXS-A03, **€ 95,-**
 - C-D** Height of stand approx. 600 mm, KERN IXS-A04, **€ 120,-**

- Internal rechargeable battery pack, operating time up to 80 h without backlight, charging time approx. 12 h, must be ordered at purchase, KERN GAB-A04, **€ 42,-**
- Data interface RS-232, interface cable included, approx. 1,5 m, must be ordered at purchase, KERN KXS-A04, **€ 109,-**
- Data interface RS-485, must be ordered at purchase, KERN KXS-A01, **€ 160,-**
- Bluetooth data interface for wireless data transfer to PC or tablets, must be ordered at purchase, not in combination with verification, KERN KXS-A02, **€ 200,-**
- Foot switch, must be ordered at purchase, KERN KXS-A03, **€ 140,-**
- Roller conveyor attachment, with smooth-running, hot-dip galvanised steel rollers with ball bearings, robust aluminium profile frame for models with weighing plate size
 - B** KERN YRO-01, **€ 720,-**
 - C** KERN YRO-02, **€ 740,-**
 - D** KERN YRO-03, **€ 1060,-**
- Further details, plenty of further accessories and suitable printers see *Accessories*

*Note: only one of the port options can be built in for use

STANDARD

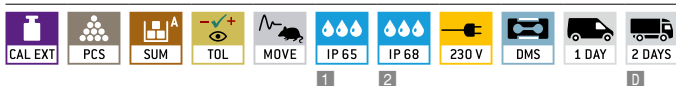

OPTION



FACTORY

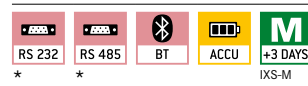

Model	Weighing range [Max] kg	Readability [d] g	Verification value [e] g	Minimal load [Min] g	Net weight approx. kg	Weighing plate	Price excl. of VAT ex works €	Option			
								Verification KERN	DAkKS €	Calibr. Certificate KERN €	
KERN IXS 6K-4	6	0,2	-	-	6	A	790,-	-	-	963-128	112,-
KERN IXS 10K-4	15	0,5	-	-	6	A	790,-	-	-	963-128	112,-
KERN IXS 10K-4L	15	0,5	-	-	11	B	860,-	-	-	963-128	112,-
KERN IXS 30K-3	30	1	-	-	11	B	860,-	-	-	963-128	112,-
KERN IXS 30K-3L	30	1	-	-	22	C	1030,-	-	-	963-128	112,-
KERN IXS 60K-3	60	2	-	-	11	B	860,-	-	-	963-129	139,-
KERN IXS 60K-3L	60	2	-	-	22	C	1030,-	-	-	963-129	139,-
KERN IXS 100K-3	150	5	-	-	22	C	1020,-	-	-	963-129	139,-
KERN IXS 100K-3L	150	5	-	-	36	D	1250,-	-	-	963-129	139,-
KERN IXS 300K-2	300	10	-	-	36	D	1250,-	-	-	963-129	139,-

Multi-range balance, with increasing load it switches automatically

to the next largest weighing range [Max] and readout [d] and when the load is fully removed, the balance switches back to the lower range

KERN IXS 6K-3M	3 6	1 2	1 2	20 40	6	A	810,-	965-228	80,-	963-128	112,-
KERN IXS 10K-3M	6 15	2 5	2 5	40 100	6	A	820,-	965-228	80,-	963-128	112,-
KERN IXS 10K-3LM	6 15	2 5	2 5	40 100	11	B	910,-	965-228	80,-	963-128	112,-
KERN IXS 30K-2M	15 30	5 10	5 10	100 200	11	B	910,-	965-228	80,-	963-128	112,-
KERN IXS 30K-2LM	15 30	5 10	5 10	100 200	22	C	1080,-	965-228	80,-	963-128	112,-
KERN IXS 60K-2M	30 60	10 20	10 20	200 400	11	B	910,-	965-229	105,-	963-129	139,-
KERN IXS 60K-2LM	30 60	10 20	10 20	200 400	22	C	1080,-	965-229	105,-	963-129	139,-
KERN IXS 100K-2M	60 150	20 50	20 50	400 1000	22	C	1080,-	965-229	105,-	963-129	139,-
KERN IXS 100K-2LM	60 150	20 50	20 50	400 1000	36	D	1260,-	965-229	105,-	963-129	139,-
KERN IXS 300K-2M	150 300	50 100	50 100	1000 2000	36	D	1270,-	965-229	105,-	963-129	139,-

Note: For applications that require verification, please order verification at the same time, initial verification at a later date is not possible.

Verification at the factory, we need to know the full address of the location of use.

ONLY WHILE STOCKS LAST

11

FLOOR SCALES/ PALLET SCALES/ DRIVE-THROUGH SCALES



From incoming goods to production and shipping – our modern, powerful floor scales can be used everywhere and intuitively. The many clever functions will assist you in carrying out processes effectively and economically, all while meeting high requirements and saving resources.

In our floor scales product category, we offer our customers a carefully coordinated product range in the weighing range from 300 to 6,000 kg. Choose between affordable entry level models, practical built-in solutions or Premium products made from stainless steel and verified. Our floor scales stand out due to their durable industrial quality as well as reliable protection against dust and water splashes.

Industrial scales for heavy loads

When weighing large containers and heavy goods, scales must overcome different challenges. As well as correspondingly large weighing ranges, a high level of stability and sturdiness is necessary, in order to withstand the maximum loads acting on the weighing plate. Our floor scales are perfectly suited for this task, for example through generously sized struts and material thicknesses, mobile stored adjustable feet for the protection of the load cells, IP67 protection against dust and water splashes or a convenient disconnect device between the display device and platform. The latter means that you can install a verified scale in a packing and dispatch bench or a pit frame for barrier-free access at a later date. Large LCD displays make it easier to read the display even if the angle of view is not ideal. We also have pallet scales, weighing beams and drive-through scales available for versatile use.

Our recommendation: High-resolution KERN BIC floor scale with $2 \times 3,000$ [d] at the best price-to-performance ratio.

Easy integration through digital interfaces

Thanks to interfaces such as RS-232, USB, Bluetooth, WiFi, Ethernet the scale can easily be connected to existing networks. Data exchange between scale and PC or printer is easy and reliable. The standardised KCP interface (Kern Communication Protocol) takes over the searching and remote control of the scale using external control devices or computers. KCP enables you to recall and control the relevant parameters and device functions and is also compatible with the MT-SICS protocol in most cases.

Our recommendation: High-resolution multi-range pallet scale KERN UID with EC type approval [M] and various data interfaces.

The KERN calibration and verification service

In order to fulfil quality requirements in accordance with DIN EN ISO 9000ff and other standards, we can offer our customers DAKkS calibration. Calibration ensures correct, usable weighing results and makes the floor scale into a reliable measuring and testing instrument. When calibrating, deviations in the display will be identified and documented. The main points to remember are: DAKkS calibration is always sensible, when checking equipment is to be used in a QM process. While calibration is not legally regulated, verification is mandatory in different applications for example:

- In commercial trade, if the price of goods are determined by weighing results.
- In the production of pre-packaged goods
- In the pharmaceutical industry
- For official purposes.

Our recommendation: BID floor scale with EC type approval [M] and the best price-to-performance ratio – now also as a high-resolution multi-range balance

Individual solutions for maximum efficiency

The weighing ranges of bench counting scales are often not sufficient to count large quantities, units or items on pallets. This is where high-performance counting systems come into their own, as these combine a high-precision reference scale with a high-capacity bulk scale, such as for example a floor scale, pallet scale or drive-through scale.

If you have special requirements, you can also configure your ideal scale easily and quickly so that it meets your needs. We will put your weighing combination together for you, using the components you have selected and including verification. Please contact your personal customer advisor for further information!

Quick-Finder Floor scales/Pallet scales/Drive-through scales

Readability [d] g	Weighing capacity [Max] kg	Weighing plate W×D×H mm	Model KERN	Price excl. of VAT ex works €	Page	2 DAYS	M	RS 232	USB	BT	WIFI	LAN	KCP PROTOCOL	PCS	TOL	ACCU	
For an explanation on the pictos, see front flap																	
50 100	300 600	1000×1000×108	BID 600K-1DS	1350,-	114	2											
50 100	300 600	1200×1500×108	BID 600K-1D	1820,-	114	2											
100	300	1000×1000×40	NIB 300K-1	890,-	124	2											
100 200	300 600	1000×1000×108	BIC 600K-1S	1080,-	113	2											
100 200	300 600	1200×1500×108	BIC 600K-1	1490,-	113	2											
100 200	300 600	1000×1000×108	BID 600K-1DSM	1350,-	114	2	○										
100 200	300 600	1200×1500×108	BID 600K-1DM	1820,-	114	2	○										
100 200	300 600	1195×840×110	UID 600K-1DM	1340,-	121	2	○										
100 200	600 1500	1000×1000×108	BID 1T-4DS	1390,-	114	2											
100 200	600 1500	1200×1500×108	BID 1T-4D	1820,-	114	2											
200	600	1000×1000×108	BID 600K-1SM	1340,-	114	2	○										
200	600	1200×1500×108	BID 600K-1M	1770,-	114	2	○										
200	600	1000×1000×85	BFB 600K-1SNM	1650,-	116	2	○										
200	600	1500×1250×85	BFB 600K-1NM	2300,-	116	2	○										
200	600	1000×1000×90	BFN 600K-1SM	3270,-	118	2	○										
200	600	800×120×84	UFA 600K-1S	1220,-	119	2											
200	600	1195×840×110	UIB 600K-1	1110,-	120	2											
200	600	1195×840×110	UID 600K-1M	1310,-	121	2	○										
200	600	1190×840×90	UFB 600K200M	1570,-	122	2	○										
200	600	1360×850×90	UFN 600K200IPM	2000,-	123	2	○										
200	600	1000×1000×40	NIB 600K-2	890,-	124	2											
200	600	1800×1400×80	NFB 600K200LM	2650,-	125	2	○										
200	600	1600×1200×80	NFB 600K200M	2270,-	125	2	○										
200	600	1600×1200×80	NFN 600K-1M	4170,-	126	2	○										
200 500	600 1500	1000×1000×108	BIC 1T-4S	1040,-	113	2											
200 500	600 1500	1200×1500×108	BIC 1T-4	1450,-	113	2											
200 500	600 1500	1000×1000×108	BID 1T-4DSM	1390,-	114	2	○										
200 500	600 1500	1200×1500×108	BID 1T-4DM	1820,-	114	2	○										
200 500	600 1500	1190×840×110	UID 1500K-1DM	1340,-	121	2	○										
200 500	1500 3000	1200×1500×108	BID 3T-3D	1820,-	114	2											
200 500	1500 3000	1500×1500×108	BID 3T-3DL	2130,-	114	2											
500	1500	1000×1000×108	BID 1T-4SM	1350,-	114	2	○										
500	1500	1200×1000×108	BID 1T-4EM	1450,-	114	2	○										
500	1500	1200×1500×108	BID 1T-4M	1770,-	114	2	○										
500	1500	1500×1500×108	BID 1T-4LM	2090,-	114	2	○										
500	1500	1000×1000×85	BFB 1T-4SNM	1640,-	116	2	○										
500	1500	1500×1250×85	BFB 1T-4NM	2310,-	116	2	○										
500	1500	1000×1000×90	BFN 1T-4SM	3270,-	118	2	○										
500	1500	1500×1250×85	BFN 1.5T0.5M	4090,-	118	2	○										
500	1500	1200×120×84	UFA 1.5T0.5	1310,-	119	2											
500	1500	1195×840×110	UIB 1.5T-4	1110,-	120	2											
500	1500	1190×840×110	UID 1500K-1M	1310,-	121	2	○										
500	1500	1190×840×90	UFB 1.5T0.5M	1520,-	122	2	○										
500	1500	1360×840×90	UFN 1.5T0.5IPM	2000,-	123	2	○										
500	1500	1600×1200×80	NFB 1.5T0.5M	2270,-	125	2	○										
500	1500	1800×1400×80	NFB 1.5T0.5LM	2650,-	125	2	○										
500	1500	1600×1200×80	NFN 1.5T-4M	4140,-	126	2	○										
500 1000	1500 3000	1500×1500×108	BIC 3T-3L	1780,-	113	2											
500 1000	1500 3000	1200×1500×108	BIC 3T-3	1450,-	113	2											
500 1000	1500 3000	1200×1500×108	BID 3T-3DM	1820,-	114	2	○										
500 1000	1500 3000	1500×1500×108	BID 3T-3DLM	2130,-	114	2	○										
500 1000	1500 3000	1190×840×110	UID 3000K-0DM	1340,-	121	2	○										
1000	3000	1200×1500×108	BID 3T-3M	1770,-	114	2	○										
1000	3000	1500×1500×108	BID 3T-3LM	2090,-	114	2	○										
1000	3000	1500×1500×85	BFB 3T1LM	2580,-	116	2	○										
1000	3000	1500×1250×85	BFB 3T-3NM	2310,-	116	2	○										
1000	3000	1200×120×84	UFA 3T1	1310,-	119	2											
1000	3000	1500×1250×85	BFN 3T-3M	4630,-	118	2	○										
1000	3000	2000×120×90	UFA 3T-3L	1650,-	119	2											
1000	3000	1195×840×110	UIB 3T-3	1110,-	120	2											
1000	3000	1195×840×110	UID 3000K-0M	1310,-	121	2	○										
2000	6000	1500×1500×130	BFB 6T-3M	3060,-	116	2	○										
2000	6000	1200×160×115	UFA 6T-3	1720,-	119	2											
2000	6000	1200×160×115	UFA 6T-3L	2240,-	119	2											

● = standard ○ = option

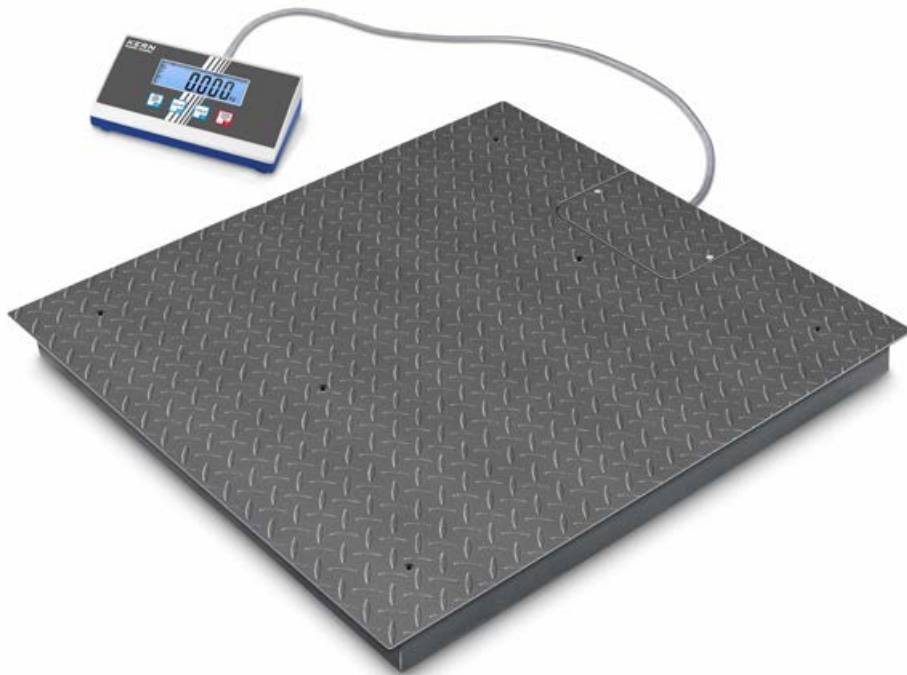

High-resolution floor scale with 2×3000 [d] and the best price-to performance ratio

Features

- 1 Weighing bridge out of anti-slip corrugated steel, 4 load cells, alloy steel, silicone-coated, IP67
- Welded platform with screw holes to lift the scale for easy cleaning
- Easy levelling of the weighing bridge as well as access to the junction box from above
- Simple and convenient 4-key operation
- Wall mount for display device, standard
- A clever plug-in connector means that you can easily separate the display device and the platform, e.g. for installing the balance in a packing and dispatch bench, pit frame etc. at a later date
- 2 Did you know? Our floor scales are delivered in a robust wooden box. This protects the high-quality weighing technology from environmental influences and stresses during transportation. KERN – always one step ahead

Technical data

- Large LCD display, digit height 25 mm
- Weighing plate dimensions, steel, powder coated
 - A W×D×H 1000×1000×108 mm
 - B W×D×H 1200×1500×108 mm
 - C W×D×H 1500×1500×108 mm
- Dimensions of display device W×D×H 235×114×51 mm
- Optional battery operation, 4×1.5 V AA not included in scope of delivery, operating time up to 60 h
- Cable length of display device approx. 5 m
- Permissible ambient temperature -10 °C/40 °C

Accessories

- Protective working cover over the display device, scope of delivery: 5 items, KERN EOB-A04BS05, € 44,-
- 3 Pair of base plates to fix the weighing bridge to the floor, KERN BIC-A07, € 44,-
- 4 Ascending ramp, steel, powder-coated, for models with weighing plate size
 - A 1000×1000×108 mm, KERN BIC-A01, € 495,-
 - B 1200×1000×108 mm, KERN BIC-A02, € 615,-
 - C 1500×1000×108 mm, KERN BIC-A03, € 720,-
- 5 Stable pit frame, Steel, for models with weighing plate size
 - A 1088×1088×110 mm, KERN BIC-A04, € 405,-
 - B 1288×1588×110 mm, KERN BIC-A05, € 540,-
 - C 1588×1588×110 mm, KERN BIC-A06, € 550,-

! Shipment via freight forwarder. Please ask for dimensions, gross weight, shipping costs

STANDARD



OPTION



Model	Weighing capacity [Max] kg	Readability [d] kg	Net weight approx. kg	Weighing plate	Price excl. of VAT ex works €	Option	
						DAKKS KERN	Calibr. Certificate €
KERN BIC 600K-1S	300 600	0,1 0,2	70	A	1080,-	963-130	196,-
BIC 600K-1	300 600	0,1 0,2	150	B	1490,-	963-130	196,-
BIC 1T-4S	600 1500	0,2 0,5	70	A	1040,-	963-130	196,-
BIC 1T-4	600 1500	0,2 0,5	150	B	1450,-	963-130	196,-
BIC 3T-3	1500 3000	0,5 1	150	B	1450,-	963-132	520,-
BIC 3T-3L	1500 3000	0,5 1	150	C	1780,-	963-132	520,-



Multi-range balance, ideal, high maximum loads need to be weighed, but in the lower load range you still need high resolution. This means that two scales can be replaced with one - which saves space and money!

11 Floor scale with EC type approval [M] and the best price-to-performance ratio – now also as high-resolution multi-range balance



Did you know? Our floor scales are delivered in a robust wooden box. This protects the high-quality weighing technology from environmental influences and stresses during transportation. KERN – always one step ahead



3 Access ramp incl. pair of base plates to facilitate access of e.g. wire cage trolleys, shelf trolleys, container trolleys, storage trolleys, sack trucks, transpallets, mobile containers, containers refuse etc.



4 Verification plug, for verified balances. This enables you to separate the display device and platform without affecting the verification, e.g. for installing the scale in a packing and dispatch table, pit frame etc. at a later date. Please order this at the same time as you purchase your scale

Floor scales KERN BID/BID-D

Features

- BID 1T-4EM: Compact special size, especially for weighing europallets
- **1** Weighing bridge out of anti-slip corrugated steel, 4 load cells, alloy steel, silicone-coated, IP67
- Easy levelling of the weighing bridge as well as access to the junction box from above
- **2** Display device: for details see KERN KIB-TM
- Totalising of weights and piece counts
- Thanks to interfaces such as RS-232 or USB, WiFi, Bluetooth, Ethernet (optional), the scale can easily be connected to existing networks. Data exchange between the scale, PC or printer
- Searching and remote control of the balance using external control devices or computers with the KERN Communication Protocol (KCP). KCP is a standardised interface command structure for KERN balances and other instruments which allows you to recall and manage all relevant parameters and device functions. You can therefore simply connect KERN devices with KCP to computers, industrial control systems and other digital systems. In a large number of cases the KCP is compatible with the MT-SICS protocol

Technical data

- Large LCD display, digit height 25 mm
- Weighing plate dimensions, W×D×H
 - A** 1000×1000×108 mm, **B** 1200×1000×108 mm
 - C** 1200×1500×108 mm, **D** 1500×1500×108 mm

- Dimensions of display device W×D×H 268×115×80 mm
- Cable length of display device approx. 5 m
- Permissible ambient temperature -10 °C/40 °C

Accessories

- Protective working cover, scope of delivery 5 items, KERN EOC-A01S05, **€ 55,-**
- Pair of base plates to fix the weighing bridge to the floor, KERN BIC-A07, **€ 44,-**
- **3** Ascending ramp, steel, powder-coated, for models with weighing plate size
 - A, B** KERN BIC-A01, **€ 495,-**
 - C** KERN BIC-A02, **€ 615,-**
 - D** KERN BIC-A03, **€ 720,-**
- Stable pit frame, Steel, powder-coated, to install the weighing bridge so you can drive straight on, for models with weighing plate size
 - A** KERN BIC-A04, **€ 405,-**
 - B** KERN BIC-A08, **€ 460,-**
 - C** KERN BIC-A05, **€ 540,-**
 - D** KERN BIC-A06, **€ 550,-**
- Benchtop stand incl. wall mount for display device, KERN EOC-A04, **€ 33,-**
- Internal rechargeable battery pack, operating time up to 43 h without backlight, charging time approx. 3 h, KERN KFB-A01, **€ 40,-**
- USB data interface, for transferring weighing to the PC, printer etc., must be ordered at purchase, KERN KIB-A03, **€ 120,-**
- Bluetooth data interface for wireless data transfer to PC or tablets, must be ordered at purchase, KERN KIB-A04, **€ 110,-**

- WiFi interface for wireless connection of the balance to networks and WiFi capable devices, such as tablets, laptops or smartphones, continuous data transfer, must be ordered at purchase, KERN KIB-A10, **€ 130,-**
- Ethernet data interface, to connect an IP-based Ethernet network, continuous data transfer, must be ordered at purchase, KERN KIB-A02, **€ 165,-**
- Signal lamp, including interface, for visual support of weighing with tolerance range, must be ordered at purchase, KERN KIB-A06, **€ 470,-**
- Alibi memory, for paperless archiving of the weighing results with ID no., gross/net/tare value, date and time, must be ordered at purchase, KERN KIB-A13, **€ 164,-**
- **4** Verification plug, for verified balances this enables you to separate the display device and platform without affecting the verification, e.g. for installing the scale in a packing and dispatch table, pit frame etc. at a later date. Please order this at the same time as you purchase your scale, KERN KIB-A12, **€ 164,-**

Note: For verified scales the weighing bridge must be fixed to the floor. Optionally, with an access ramp, a footplate pair or a pit frame

In addition to the RS-232 data interface, which is integrated as standard, only one other data interface can be installed and operated

1 Shipment via freight forwarder. Please ask for dimensions, gross weight, shipping costs

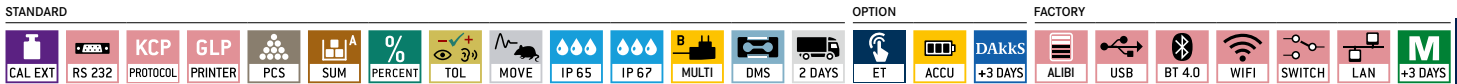

Model	Weighing capacity [Max] kg	Readability [d] kg	Verification value [e] kg	Minimal load [Min] kg	Net weight approx. kg	Weighing plate	Price excl. of VAT ex works €	Verification KERN	Option DAKKS Calibr. Certificate DAKKS KERN	Certificate €
BID 600K-1DS	300 600	0,05 0,1	-	-	70	A	1350,-	-	963-130	196,-
BID 600K-1D	300 600	0,05 0,1	-	-	150	A	1820,-	-	963-130	196,-
BID 1T-4DS	600 1500	0,1 0,2	-	-	70	A	1390,-	-	963-130	196,-
BID 1T-4D	600 1500	0,1 0,2	-	-	150	C	1820,-	-	963-130	196,-
BID 3T-3D	1500 3000	0,2 0,5	-	-	150	C	1820,-	-	963-132	520,-
BID 3T-3DL	1500 3000	0,2 0,5	-	-	155	D	2130,-	-	963-132	520,-

Multi-range balance with high-resolution display, with increasing load it switches automatically, to the next largest weighing range [Max] and readout [d] and when the load is fully removed, the balance switches back to the lower range

BID 600K-1DSM	300 600	0,1 0,2	0,1 0,2	2 4	70	A	1350,-	965-230	150,-	963-130	196,-
BID 600K-1DM	300 600	0,1 0,2	0,1 0,2	2 4	150	C	1820,-	965-230	150,-	963-130	196,-
BID 1T-4DSM	600 1500	0,2 0,5	0,2 0,5	4 10	70	A	1390,-	965-230	150,-	963-130	196,-
BID 1T-4DM	600 1500	0,2 0,5	0,2 0,5	4 10	150	C	1820,-	965-230	150,-	963-130	196,-
BID 3T-3DM	1500 3000	0,5 1	0,5 1	10 20	150	C	1820,-	965-232	225,-	963-132	520,-
BID 3T-3DLM	1500 3000	0,5 1	0,5 1	10 20	155	D	2130,-	965-232	225,-	963-132	520,-

BID 600K-1SM	600	0,2	0,2	4	70	A	1340,-	965-230	150,-	963-130	196,-
BID 600K-1M	600	0,2	0,2	4	150	C	1770,-	965-230	150,-	963-130	196,-
BID 1T-4SM	1500	0,5	0,5	10	70	A	1350,-	965-230	150,-	963-130	196,-
BID 1T-4M	1500	0,5	0,5	10	150	C	1770,-	965-230	150,-	963-130	196,-
BID 1T-4EM	1500	0,5	0,5	10	85	B	1450,-	965-230	150,-	963-130	196,-
BID 1T-4LM	1500	0,5	0,5	10	155	D	2090,-	965-230	150,-	963-130	196,-
BID 3T-3M	3000	1	1	20	150	C	1770,-	965-232	225,-	963-132	520,-
BID 3T-3LM	3000	1	1	20	155	D	2090,-	965-232	225,-	963-132	520,-

Note: For applications that require verification, please order verification at the same time, initial verification at a later date is not possible.

Verification at the factory, we need to know the full address of the location of use.



11

Weighing bridge with screwed-on weighing plate (IP67) and XXL display device, with EC type approval [M]



Weighing plate can be unscrewed - The weighing plate can be conveniently unscrewed for maintenance or cleaning purposes



Easy levelling of the weighing bridge as well as access to the junction box from above



Did you know? Our floor scales are delivered in a robust wooden box. This protects the high-quality weighing technology from environmental influences and stresses during transportation. KERN - always one step ahead

Floor scale KERN BFB



Features

- Weighing **A**, **B**, **C** plate screwed on from the top, so it easy to remove, hygienic and easy to clean
- Models with weighing plate size **A**, **B**, **C**: Weighing bridge: steel, powder coated
Models with weighing plate size **D**: Weighing bridge: corrugated steel
- 4 silicone-coated steel load cells, dust and spray protection IP67
- Display device: for details see KERN KFB-TAM
- Benchtop stand incl. wall mount for display device as standard
- Totalising of weights and piece counts
- Protective working cover included with delivery

Technical data

- Large backlit LCD display, digit height 52 mm
- Weighing plate dimensions, steel, powder coated
A W×D×H 1000×1000×85 mm
B W×D×H 1500×1250×85 mm
C W×D×H 1500×1500×85 mm
D W×D×H 1500×1500×130 mm
- Dimensions of display device W×D×H 250×160×58 mm
- Cable length of display device approx. 5 m
- Permissible ambient temperature -10 °C/40 °C

Accessories

- Protective working cover, scope of delivery 5 items, KERN KFB-A02S05, **€ 44,-**
- **2** Stand to elevate display device, Height of stand approx. 800 mm, KERN BFS-A07, **€ 170,-**
- Pair of base plates to fix the weighing bridge to the floor, for models with weighing plate size **A**, **B**, **C** KERN BFS-A06N, **€ 80,-**
D KERN BFS-A10, **€ 67,-**
- **3** Ascending ramp, steel, lacquered, not included, for models with weighing plate size **B** KERN BFS-A02N, **€ 510,-**
C KERN BFS-A09N, **€ 685,-**
D KERN BFS-A11, **€ 670,-**
- **4** Stable pit frame, Steel, for models with weighing plate size
A KERN BFS-A03N, **€ 440,-**
B KERN BFS-A04N, **€ 1020,-**
C KERN BFS-A08N, **€ 570,-**
- Internal rechargeable battery pack, operating time up to 35 h without backlight, charging time approx. 10 h, must be ordered at purchase, KERN KFB-A01, **€ 40,-**
- Bluetooth data interface for wireless data transfer to PC or tablets, must be ordered at purchase, not in combination with verification, When installing the Bluetooth data interface, the RS-232 data interface can no longer be used, KERN KFB-A03, **€ 160,-**

- Analogue module, not possible in combination with signal lamp
Analogue module 0-10 V, must be ordered at purchase, KERN KFB-A04, **€ 170,-**
Analogue module 4-20 mA, must be ordered at purchase, KERN KFB-A05, **€ 170,-**
- Signal lamp for visual support of weighing with tolerance range, KERN CFS-A03, **€ 330,-**
- Large display with superior display size, KERN YKD-A02, **€ 310,-**
- Cable with special length 15 m, between display device and platform, for verified models which must be ordered at the time of purchase, KERN BFB-A03, **€ 198,-**
- Further details, plenty of further accessories and suitable printers see *Accessories*

Note: For verified scales the weighing bridge must be fixed to the floor. Optionally, with an access ramp, a footplate pair or a pit frame

I Shipment via freight forwarder. Please ask for dimensions, gross weight, shipping costs

STANDARD

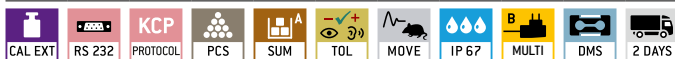

OPTION



FACTORY



Model	Weighing capacity [Max] kg	Readability = Verification value [d] = [e] kg	Minimal load [Min] kg	Net weight approx. kg	Weighing plate	Price excl. of VAT ex works €	Verification		Option DAKKS Calibr. Certificate	
							M III KERN	€	DAKKS KERN	€
BFB 600K-1SNM	600	0,2	4	105	A	1650,-	965-230	150,-	963-130	196,-
BFB 600K-1NM	600	0,2	4	140	B	2300,-	965-230	150,-	963-130	196,-
BFB 1T-4SNM	1500	0,5	10	105	A	1640,-	965-230	150,-	963-130	196,-
BFB 1T-4NM	1500	0,5	10	140	B	2310,-	965-230	150,-	963-130	196,-
BFB 3T-3NM	3000	1	20	140	B	2310,-	965-232	225,-	963-132	520,-
BFB 3T-1LM	3000	1	20	155	C	2580,-	965-232	225,-	963-132	520,-
BFB 6T-3M	6000	2	40	230	D	3060,-	965-232	225,-	963-132	520,-

Note: For applications that require verification, please order verification at the same time, initial verification at a later date is not possible.

Verification at the factory, we need to know the full address of the location of use.

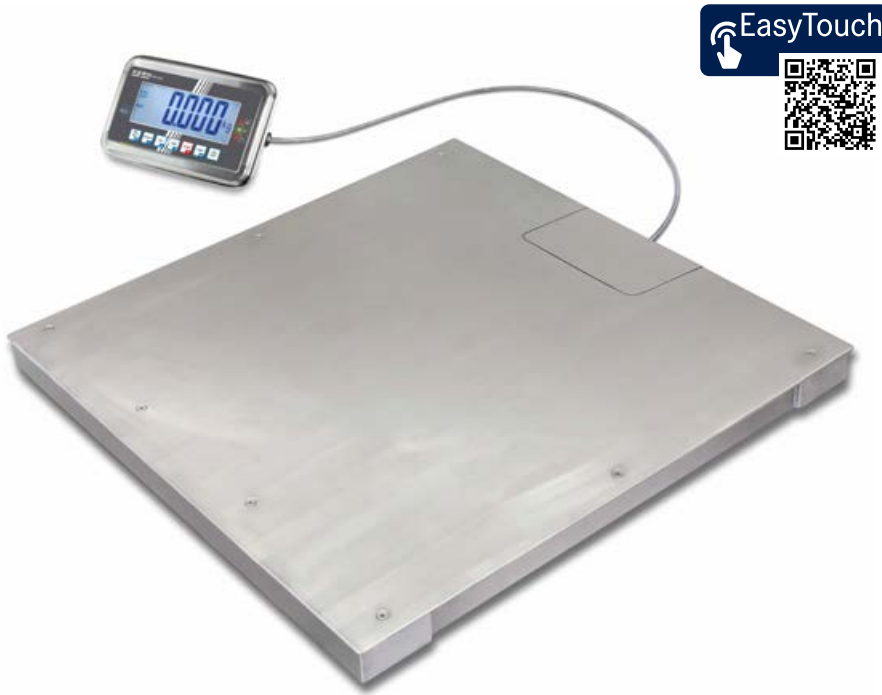

Stainless steel weighing bridge with screwed-on weighing plate (IP68) and stainless steel display device (IP65), with EC type approval [M]

Features

- Tough industry standard suitable for use in harsh industrial applications
- Weighing plate screwed on from the top with stainless steel screws, so it's easy to remove, hygienic and easy to clean
- **1** Weighing bridge: stainless steel, extremely resistant to bending due to material thickness, 4 welded stainless steel load cells, dust and spray protection IP68. Weighing bridge can also be delivered as component without the display device, for details see KERN KFP-V40
- Your support in a HACCP-compliant quality system
- Easy levelling of the weighing bridge as well as access to the junction box from above
- **2** Display device: Stainless steel, protection against dust and water splashes IP65. Ideal for industrial applications, hygienic and easy to clean. The display device can also be delivered as a component without the weighing bridge, for details see KERN KFN-TM
- Benchtop stand incl. wall mount for display device as standard

- Totalising of weights and piece counts
- Internal rechargeable battery pack included with the delivery
- **3** Did you know? Our floor scales are delivered in a robust wooden box. This protects the high-quality weighing technology from environmental influences and stresses during transportation. KERN – always one step ahead

Technical data

- Large backlit LCD display, digit height 52 mm
- Dimensions of weighing plate W×D×H
 - A** 1000×1000×90 mm
 - B** 1500×1250×85 mm
- Dimensions of display device W×D×H 266×165×96 mm
- Cable length of display device approx. 5 m
- Permissible ambient temperature -10 °C/40 °C

Accessories

- **4** Stand to elevate display device, height of stand approx. 800 mm, KERN BFN-A04, € 355,-

- Pair of base plates to fix the weighing bridge to the floor, KERN BFN-A03, € 95,-
- **5** Ascending ramp, stainless steel, for models with weighing plate size
 - A** KERN BFN-A05, € 1310,-
 - B** KERN BFN-A01, € 1470,-
- **6** Stable pit frame, Stainless steel, for models with weighing plate size
 - A** KERN BFN-A06, € 950,-
 - B** KERN BFN-A02, € 1180,-
- Data interface RS-232, interface cable included, approx. 1,5 m, must be ordered at purchase, KERN KFN-A01, € 220,-
- Bluetooth data interface, must be ordered at purchase, not possible in combination with verification, KERN KFB-A03, € 160,-
- Analogue module, must be ordered at purchase 0-10 V, KERN KFB-A04, € 170,- 4-20 mA, KERN KFB-A05, € 170,-
- Cable with special length 15 m, between display device and platform, for verified models which must be ordered at the time of purchase, KERN BFB-A03, € 198,-
- Further details, plenty of further accessories and suitable printers see *Accessories*

Note: For verified scales the weighing bridge must be fixed to the floor. Optionally, with an access ramp, a footplate pair or a pit frame.

1 Shipment via freight forwarder. Please ask for dimensions, gross weight, shipping costs-device on request.

Optionally configurable with IP68 display device on request, for details see chapter 13

STANDARD



OPTION



FACTORY

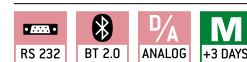

Model	Weighing capacity [Max] kg	Readability = Verification value [d] = [e] kg	Minimal load [Min] kg	Net weight approx. kg	Weighing plate	Price excl. of VAT ex works €	Verification		Option	
							KERN	€	DAkkS KERN	Certificate DAKKS KERN €
BFN 600K-1SM	600	0,2	4	100	A	3270,-	965-230	150,-	963-130	196,-
BFN 1T-4SM	1500	0,5	10	100	A	3270,-	965-230	150,-	963-130	196,-
BFN 1.5T0.5M	1500	0,5	10	145	B	4090,-	965-230	150,-	963-130	196,-
BFN 3T-3M	3000	1	20	150	B	4630,-	965-232	225,-	963-132	520,-

Note: For applications that require verification, please order verification at the same time, initial verification at a later date is not possible.

Verification at the factory, we need to know the full address of the location of use.

* Not possible in combination with RS-232 data interface



Highly versatile weighing beams (IP67) for large loads to 6 t

Features

- Flexible solution for weighing large, bulky or long items, thanks to freely positionable weighing beams and a 5 m (!) long connecting cable between the beams
- High mobility: thanks to rechargeable battery operation (optional), compact, lightweight construction, it is suitable for the use in several locations
- **1** Weighing beams: steel, painted, 4 silicone-coated aluminium load cells, protection against dust and water splashes IP67, weighing beams can also be delivered as components without the display device, for details see KERN KFA-V20
- **2** Sturdy handles for transporting the weighing beams
- **2** KERN UFA-L: Each weighing beam has a roller and handle for easy transport of the scale, see larger picture
- Display device: for details see KERN KFB-TM
- Benchtop stand incl. wall mount for display device as standard

- Totalising of weights and piece counts
- Protective working cover included with delivery
- KERN UFA-S: Model with short weighing beams, ideal for weighing compact items or animals in transport boxes
- Did you know? Our floor scales are delivered in a robust wooden box. This protects the high-quality weighing technology from environmental influences and stresses during transportation. KERN – always one step ahead

Technical data

- Large backlit LCD display, digit height 52 mm
- Dimensions of display device WxDxH 250x160x65 mm
- Cable length of display device approx. 5 m
- Cable length weighing beams approx. 5 m
- Permissible ambient temperature -10 °C/40 °C

Accessories

- Protective working cover, scope of delivery 5 items, KERN KFB-A02S05, € 44,-
- **3** Stand to elevate display device, Height of stand approx. 800 mm, KERN BFS-A07, € 170,-
- Internal rechargeable battery pack, operating time up to 35 h without backlight, charging time approx. 10 h, KERN KFB-A01, € 40,-
- Bluetooth data interface, must be ordered at purchase. When installing the Bluetooth data interface, the RS-232 data interface can no longer be used, KERN KFB-A03, € 160,-
- Analogue module, not possible in combination with signal lamp, must be ordered at purchase, 0-10 V, KERN KFB-A04, € 170,- 4-20 mA, KERN KFB-A05, € 170,-
- **4** Signal lamp for visual support of weighing with tolerance range, not possible in combination with analogue module, KERN CFS-A03, € 330,-
- **5** Large display with superior display size, KERN YKD-A02, € 310,-
- Y-cable for parallel connection of two terminal devices to the RS-232 interface on the scale, e.g. signal lamp and printer, KERN CFS-A04, € 38,-
- Cable with special length 15 m, between display device and platform, for verified models which must be ordered at the time of purchase, KERN BFB-A03, € 198,-
- Further details, plenty of further accessories and suitable printers see *Accessories*

1 Shipment via freight forwarder. Please ask for dimensions, gross weight, shipping costs

STANDARD



OPTION



FACTORY



Model	Weighing capacity [Max] kg	Readability [d] kg	Net weight approx. kg	Dimensions Weighing beam WxDxH mm	Price excl. of VAT ex works €	Option	
						DAkKS KERN	Calibr. Certificate €
KERN UFA 600K-1S	600	0,2	36	800x120x84	1220,-	963-130	196,-
KERN UFA 1.5T0.5	1500	0,5	40	1200x120x84	1310,-	963-130	196,-
KERN UFA 3T1	3000	1	38	1200x120x84	1310,-	963-132	520,-
KERN UFA 3T-3L	3000	1	60	2000x120x90	1650,-	963-132	520,-
KERN UFA 6T-3	6000	2	95	1200x160x115	1720,-	963-132	520,-
KERN UFA 6T-3L	6000	2	130	2000x160x115	2240,-	963-132	520,-

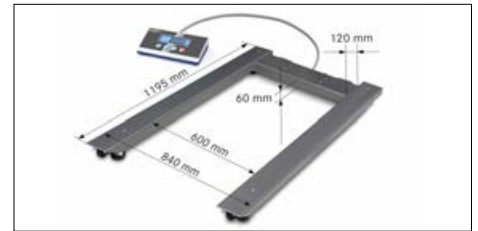

Pallet scale with steel load support (IP67) and the best price-to-performance ratio

Features

- High mobility: thanks to battery operation, compact, lightweight construction, it is suitable for the use in several locations
- **1** Load support: steel, powder coated, 4 silicone-coated aluminium load cells, protection against dust and water splashes IP67
- **2** The scale can be easily transported using rollers and a handle and does not require much storage space
- Protective working cover included with delivery
- **3** Did you know? Our floor scales are delivered in a robust wooden box. This protects the high-quality weighing technology from environmental influences and stresses during transportation. KERN – always one step ahead

Technical data

- Large LCD display, digit height 25 mm
- Dimensions of display device W×D×H 235×114×51 mm
- Cable length of display device approx. 5 m
- Optional battery operation, 4×1.5 V AA not included in scope of delivery, operating time up to 60 h
- Permissible ambient temperature -10 °C/40 °C

Accessories

- Protective working cover over the display device, scope of delivery: 5 items, KERN EOB-A04BS05, € 44,-
- Stand to elevate display device, height of stand approx. 1000 mm, KERN EOB-A02B, € 142,-

11

1 Shipment via freight forwarder. Please ask for dimensions, gross weight, shipping costs

STANDARD

CAL EXT UNIT MOVE IP 67 BATT MULTI DMS 2 DAYS

OPTION

DAkkS +3 DAYS

Model	Weighing capacity	Readability	Net weight	Price		
				excl. of VAT	Option	Certificate
	[Max] kg	[d] kg	approx. kg	€	DAkkS KERN	€
KERN						
UIB 600K-1	600	0,2	55	1110,-	963-130	196,-
UIB 1.5T-4	1500	0,5	55	1110,-	963-130	196,-
UIB 3T-3	3000	1	55	1110,-	963-132	520,-



- Net weight approx. 44 kg
- Permissible ambient temperature -10 °C/40 °C

Accessories

- Protective working cover, scope of delivery 5 items, KERN EOC-A01S05, € 55,-
- Stand to elevate display device, Height of stand approx. 800 mm, KERN BFS-A07, € 170,-
- Internal rechargeable battery pack, operating time up to 43 h without backlight, charging time approx. 3 h, KERN KFB-A01, € 40,-
- USB data interface, for transferring weighing to the PC, printer etc., must be ordered at purchase, KERN KIB-A03, € 120,-
- Bluetooth data interface for wireless data transfer to PC or tablets, must be ordered at purchase, KERN KIB-A04, € 110,-
- WiFi interface for wireless connection of the balance to networks and WiFi capable devices, such as tablets, laptops or smartphones, continuous data transfer, must be ordered at purchase, KERN KIB-A10, € 130,-
- Ethernet data interface, to connect an IP-based Ethernet network, continuous data transfer, must be ordered at purchase, KERN KIB-A02, € 165,-
- Signal lamp, including interface, for visual support of weighing with tolerance range, must be ordered at purchase, KERN KIB-A06, € 470,-
- Alibi memory, including USB interface for exporting weighing results to external data storage media, such as, for example, USB sticks, hard drives, etc., must be ordered at purchase, KERN KIB-A01, € 175,-
- Verification plug, for verified balances this enables you to separate the display device and platform without affecting the verification, e.g. for installing the scale in a packing and dispatch table, pit frame etc. at a later date. Please order this at the same time as you purchase your scale, KERN KIB-A12, € 164,-

High-resolution multi-range pallet scale with EC type approval [M] and a wide range of interfaces

Features

- Multi-range pallet scale! Ideal, when high maximum loads need to be weighed, but in the lower load range you still need high resolution. This means that two balances can be replaced with one - which saves space and money!
- High mobility thanks to battery operation for display device and platform
- 1 Display device: Protection against dust and water splashes IP65
- 2 Load support: steel, powder coated, 4 load cells, alloy steel, silicone-coated, protection against dust and water splashes IP67
- The scale can be easily transported using rollers and a handle and does not require much storage space
- Totalising of weights and piece counts
- Searching and remote control of the balance using external control devices or computers with the KERN Communication Protocol

(KCP). KCP is a standardised interface command structure for KERN balances and other instruments which allows you to recall and manage all relevant parameters and device functions. You can therefore simply connect KERN devices with KCP to computers, industrial control systems and other digital systems. In a large number of cases the KCP is compatible with the MT-SICS protocol.

- Thanks to interfaces such as RS-232 or USB, WiFi, Bluetooth, Ethernet (optional), the scale can easily be connected to existing networks. Data exchange between the scale, PC or printer
- Protective working cover included with delivery

Technical data

- Large LCD display, digit height 25 mm
- Dimensions of display device WxDxH 268x115x80 mm

*Note: Only one optional interface can be installed and used

1 Shipment via freight forwarder. Please ask for dimensions, gross weight, shipping costs

STANDARD: CAL EXT, RS 232, KCP, GLP, PCS, SUM, PERCENT, UNIT, TOL, MOVE, IP 65, IP 67, MULTI, DMS, 2 DAYS

OPTION: ET, ACCU, +3 DAYS, ALIBI, USB, BT 4.0, WIFI, LAN, +3 DAYS

FACTORY: M

Model	Weighing capacity [Max] kg	Readability = Verification value [d] = [e] kg	Minimal load [Min] kg	Cable length of display device approx. m	Net weight approx. kg	Price excl. of VAT ex works €	Option			
							Verification M KERN €	DAkkS Calibr. KERN €	Certificate KERN €	
UID 600K-1M	600	0,2	4	5	44	1310,-	965-230	150,-	963-130	196,-
UID 1500K-1M	1500	0,5	10	5	44	1310,-	965-230	150,-	963-130	196,-
UID 3000K-0M	3000	1	20	5	44	1310,-	965-232	225,-	963-132	520,-
Multi-range balance, with increasing load it switches automatically to the next largest weighing range [Max] and readout [d] and when the load is fully removed, the balance switches back to the lower range										
UID 600K-1DM	300 600	0,1 0,2	2 4	5	44	1340,-	965-230	150,-	963-130	196,-
UID 1500K-1DM	600 1500	0,2 0,5	4 10	5	44	1340,-	965-230	150,-	963-130	196,-
UID 3000K-0DM	1500 3000	0,5 1	10 20	5	44	1340,-	965-232	225,-	963-132	520,-

Note: For applications that require verification, please order verification at the same time, initial verification at a later date is not possible. Verification at the factory, we need to know the full address of the location of use.



Pallet scale with steel load support (IP67) and EC type approval [M]

Features

- High mobility: thanks to rechargeable battery operation (optional), compact, lightweight construction, it is suitable for the use in several locations
- Display device: for details see KERN KFB-TM
- **1** Load support: steel, powder coated, Weighing bridge can also be delivered as component without the display device, for details see KERN KFV-V20
- 4 load cells, alloy steel, silicone-coated, IP67
- Two wheels for easy transportation of the scale
- Weighing with tolerance range (checkweighing): A visual and audible signal assists the rapid checking of items on pallets
- Totalising of weights and piece counts
- Protective working cover included with delivery
- **2** Did you know? Our floor scales are delivered in a robust wooden box. This protects the high-quality weighing technology from environmental influences and stresses during transportation. KERN – always one step ahead

Technical data

- Large backlit LCD display, digit height 52 mm
- Dimensions of display device WxDxH 250x160x58 mm
- Cable length of display device approx. 5 m
- Permissible ambient temperature -10 °C/40 °C

Accessories

- Protective working cover, scope of delivery 5 items, KERN KFB-A02S05, € 44,-
- **3** Stand to elevate display device, Height of stand approx. 800 mm, KERN BFS-A07, € 170,-
- Internal rechargeable battery pack, operating time up to 35 h without backlight, charging time approx. 12 h, must be ordered at purchase, KERN KFB-A01, € 40,-
- Bluetooth data interface for wireless data transfer to PC or tablets, must be ordered at purchase, not in combination with verification. When installing the Bluetooth data interface, the RS-232 data interface can no longer be used, KERN KFB-A03, € 160,-

- Analogue module, not possible in combination with signal lamp, must be ordered at purchase 0-10 V, KERN KFB-A04, € 170,- 4-20 mA, KERN KFB-A05, € 170,-
- **4** Signal lamp for visual support of weighing with tolerance range, not possible in combination with analogue module, KERN CFS-A03, € 330,-
- **5** Large display with superior display size, KERN YKD-A02, € 310,-
- Y-cable for parallel connection of two terminal devices to the RS-232 interface on the scale, e.g. signal lamp and printer, KERN CFS-A04, € 38,-
- Cable with special length 15 m, between display device and platform, for verified models which must be ordered at the time of purchase, KERN BFB-A03, € 198,-
- Further details, plenty of further accessories and suitable printers see *Accessories*

1 Shipment via freight forwarder. Please ask for dimensions, gross weight, shipping costs

STANDARD												OPTION		FACTORY				
												+3 DAYS		+3 DAYS				

Model	Weighing capacity [Max] kg	Readability [d] kg	Verification value [e] kg	Minimal load [Min] kg	Net weight approx. kg	Price excl. of VAT ex works €	Option			
							Verification KERN	DAKkS	Calibr. Certificate KERN	
KERN UFB 600K200M	600	0,2	0,2	4	55	1570,-	965-230	150,-	963-130	196,-
KERN UFB 1.5T0.5M	1500	0,5	0,5	10	55	1520,-	965-230	150,-	963-130	196,-

Note: For applications that require verification, please order verification at the same time, initial verification at a later date is not possible. Verification at the factory, we need to know the full address of the location of use.



Pallet scale with stainless steel load support (IP67) and stainless steel display device (IP65), with EC type approval [M]

Features

- High mobility: thanks to rechargeable battery operation, compact, lightweight construction, it is suitable for the use in several locations (production, warehouse, dispatch department etc.)
- **1** Load support: stainless steel, Weighing bridge can also be delivered as component without the display device, for details see KERN KFU-V30
- 4 silicone-coated steel load cells, dust and spray protection IP67
- Your support in a HACCP-compliant quality system
- Ideal for the increased hygienic requirements in the food industries
- **2** Display device: for details see KERN KFN-TM
- The scale can be easily transported using rollers and a handle and does not require much storage space
- Hold function: When the weighing conditions are unstable, a stable weight is calculated determining an average value

- Weighing with tolerance range (checkweighing): A visual and audible signal assists the rapid checking of items on pallets
- Totalising of weights
- **3** Did you know? Our floor scales are delivered in a robust wooden box. This protects the high-quality weighing technology from environmental influences and stresses during transportation. KERN – always one step ahead

Technical data

- Large backlit LCD display, digit height 52 mm
- Dimensions of display device WxDxH 266x165x96 mm
- Cable length of display device approx. 5 m
- Permissible ambient temperature -10 °C/40 °C

Accessories

- **4** Stand to elevate display device, height of stand approx. 800 mm, KERN BFN-A04, € 355,-
- Internal rechargeable battery pack, operating time up to 35 h without backlight, charging time approx. 10 h, KERN GAB-A04, € 42,-
- RS-232 data interface including interface cable, Data interface RS-232, interface cable included, approx. 1,5 m, must be ordered at purchase, KERN KFN-A01, € 220,-
- Bluetooth data interface for wireless data transfer to PC or tablets, must be ordered at purchase, not possible in combination with verification, KERN KFB-A03, € 160,-
- Analogue module 0-10 V, must be ordered at purchase, KERN KFB-A04, € 170,-
Analogue module 4-20 mA, must be ordered at purchase, KERN KFB-A05, € 170,-
- Large display with superior display size, KERN YKD-A02, € 310,-
- Cable with special length 15 m, between display device and platform, for verified models which must be ordered at the time of purchase, KERN BFB-A03, € 198,-
- Further details, plenty of further accessories and suitable printers see *Accessories*

1 Shipment via freight forwarder. Please ask for dimensions, gross weight, shipping costs
Optionally configurable with IP68 display device on request, for details see chapter 13

STANDARD



OPTION



FACTORY

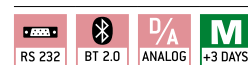

Model	Weighing capacity [Max] kg	Readability = Verification value [d] = [e] kg	Verification value [e] kg	Minimal load [Min] kg	Net weight approx. kg	Price excl. of VAT ex works €	Option			
							Verification KERN €	DAkkS KERN €	Calibr. Certificate KERN €	
KERN UFN 600K200IPM	600	0,2	0,2	4	55	2000,-	965-230	150,-	963-130	196,-
KERN UFN 1.5T0.5IPM	1500	0,5	0,5	10	50	2000,-	965-230	150,-	963-130	196,-

Note: For applications that require verification, please order verification at the same time, initial verification at a later date is not possible.
Verification at the factory, we need to know the full address of the location of use.



Compact, robust drive-through scale – particularly mobile thanks to its carrying handle, rollers and lightweight construction

Features

- Drive-through scale for rapid weighing of e.g. wire cage trolleys, shelf trolleys, container trolleys, storage trolleys, sack trucks, transpallets, mobile containers, containers refuse etc.
- Low platform height and integrated access ramps on both sides facilitate access. No need for pit frame installation – which saves money
- **1** Weighing bridge: Steel, powder coated, 4 silicon-coated aluminium load cells with protection against dust and water splashes to IP67
- **2** Level indicator to level the balance precisely
- **3** The scale can be easily transported using rollers and a handle and does not require much storage space
- Wall mount for the display device, as standard, only for models without a stand
- Protective working cover included with delivery
- **4** Did you know? Our floor scales are delivered in a robust wooden box. This protects the high-quality weighing technology from environmental influences and stresses during transportation. KERN – always one step ahead

Technical data

- Large LCD display, digit height 25 mm
- Platform height in the drive-through area: 40 mm
- Dimensions weighing surface, steel, painted W×D 800×800 mm (Without ramps) W×D×H 1000×1000×40 mm
- Dimensions of display device W×D×H 235×114×51 mm
- Cable length of display device approx. 5 m
- Optional battery operation, 4×1.5 V AA not included in scope of delivery, operating time up to 60 h
- Permissible ambient temperature -10 °C/40 °C

Accessories

- Protective working cover over the display device, scope of delivery: 5 items, KERN EOB-A04BS05, **€ 44,-**
- Pair of base plates to fix the weighing bridge to the floor, KERN BIC-A07, **€ 44,-**

11

STANDARD



OPTION



Model	Weighing capacity [Max] kg	Readability [d] kg	Net weight approx. kg	Price	Option	
				excl. of VAT ex works €	DAkKS Calibr. Certificate DAKKS KERN	Certificate €
NIB 300K-1	300	0,1	40	890,-	963-129	139,-
NIB 600K-2	600	0,2	40	890,-	963-130	196,-



Drive-through scale (IP67) with XXL display device and EC type approval [M]

Features

- Drive-through scale for rapid weighing of e.g. wire cage trolleys, shelf trolleys, container trolleys, storage trolleys, sack trucks, trans-pallets, mobile containers, containers refuse etc.
- Low platform height and integrated access ramps on both sides facilitate access. No need for pit frame installation – which saves money
- **1** Weighing bridge: out of anti-slip corrugated steel, 4 silicone-coated steel load cells, dust and spray protection IP67
- Display device: for details see KERN KFB-TM
- Protective working cover included with delivery
- **2** Did you know? Our floor scales are delivered in a robust wooden box. This protects the high-quality weighing technology from environmental influences and stresses during transportation. KERN – always one step ahead

Technical data

- Large backlit LCD display, digit height 52 mm
- Weighing plate dimensions
 - A** W×D 1000×1000 mm (Without ramps)
 - B** W×D 1200×1200 mm (Without ramps)
- Overall dimensions
 - A** W×D×H 1600×1200×80 mm
 - B** W×D×H 1800×1400×80 mm
- Platform height in the drive-through area: 80 mm
- Dimensions of display device W×D×H 250×160×58 mm
- Permissible ambient temperature -10 °C/40 °C

Accessories

- Protective working cover, scope of delivery 5 items, KERN KFB-A02S05, **€ 44,-**
- **3** Stand to elevate display device, Height of stand approx. 800 mm, KERN BFS-A07, **€ 170,-**
- Pair of base plates to fix the weighing bridge to the floor, KERN BFS-A06, **€ 75,-**
- Internal rechargeable battery pack, operating time up to 35 h without backlight, charging time approx. 10 h, must be ordered at purchase, KERN KFB-A01, **€ 40,-**

- Bluetooth data interface for wireless data transfer to PC or tablets, must be ordered at purchase, not in combination with verification. When installing the Bluetooth data interface, the RS-232 data interface can no longer be used, KERN KFB-A03, **€ 160,-**
- Analogue module, not possible in combination with signal lamp
 - Analogue module 0-10 V, must be ordered at purchase, KERN KFB-A04, **€ 170,-**
 - Analogue module 4-20 mA, must be ordered at purchase, KERN KFB-A05, **€ 170,-**
- **4** not possible in combination with analogue module, Signal lamp for visual support of weighing with tolerance range, KERN CFS-A03, **€ 330,-**
- **5** Large display with superior display size, KERN YKD-A02, **€ 310,-**
- Y-cable for parallel connection of two terminal devices to the RS-232 interface on the scale, e.g. signal lamp and printer, KERN CFS-A04, **€ 38,-**
- Cable with special length 15 m, between display device and platform, for verified models which must be ordered at the time of purchase, KERN BFB-A03, **€ 198,-**
- Further details, plenty of further accessories and suitable printers see *Accessories*

Note: For verified scales the weighing bridge must be fixed to the floor. Optionally, with an access ramp, a footplate pair or a pit frame

1 Shipment via freight forwarder. Please ask for dimensions, gross weight, shipping costs

STANDARD

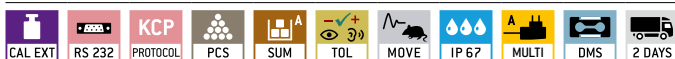

OPTION



FACTORY



Model	Weighing capacity [Max] kg	Readability = Verific. value [d] = [e] kg	Minimal load [Min] kg	Cable length of display device approx. m	Net weight approx. kg	Weighing plate	Price excl. of VAT ex works €	Option			
								Verification KERN	€	DAkKS KERN	Certificate €
KERN NFB 600K200M	600	0,2	4	5	140	A	2270,-	965-230	150,-	963-130	196,-
NFB 600K200LM	600	0,2	4	5	165	B	2650,-	965-230	150,-	963-130	196,-
NFB 1.5T0.5M	1500	0,5	10	5	140	A	2270,-	965-230	150,-	963-130	196,-
NFB 1.5T0.5LM	1500	0,5	10	5	155	B	2650,-	965-230	150,-	963-130	196,-

Note: For applications that require verification, please order verification at the same time, initial verification at a later date is not possible. Verification at the factory, we need to know the full address of the location of use.



Stainless steel drive-through scale (IP68) with stainless steel display device (IP65), with EC type approval [M]

Features

- Robust stainless steel drive-through scale for rapid weighing of e.g. laundry carts, container trolleys, roller containers, etc. Ideal for hospital laundry services, goods inwards, hospital kitchens, etc.
- Low platform height and integrated access ramps on both sides facilitate access. No need for pit frame installation – which saves money
- Ideal for the ever-increasing hygienic requirements in the food, pharmaceutical and chemical industries.
- Your support in a HACCP-compliant quality system
- **1** Weighing bridge: stainless steel, extremely resistant to bending due to material thickness, 4 welded stainless steel load cells, dust and spray protection IP68. Weighing bridge can also be delivered as component without the display device, for details see KERN KFD-V40
- **2** Display device: for details see KERN KFN-TM
- Totalising of weights and piece counts
- Internal rechargeable battery pack included with the delivery

- **3** Did you know? Our floor scales are delivered in a robust wooden box. This protects the high-quality weighing technology from environmental influences and stresses during transportation. KERN – always one step ahead

Technical data

- Large backlit LCD display, digit height 52 mm
- Weighing plate dimensions WxD 1000x1000 mm (Without ramps)
- Platform height in the drive-through area: 80 mm
- Overall dimensions WxDxH 1600x1200x80 mm
- Dimensions of display device WxDxH 266x165x96 mm
- Permissible ambient temperature -10 °C/40 °C

Accessories

- **4** Stand to elevate display device, height of stand approx. 750 mm, KERN YKP-02, € 220,-
- Pair of base plates to fix the weighing bridge

- to the floor, KERN BFN-A03, € 95,-
- Internal rechargeable battery pack, operating time up to 35 h without backlight, charging time approx. 12 h, KERN GAB-A04, € 42,-
- Data interface RS-232, interface cable included, approx. 1,5 m, must be ordered at purchase, KERN KFN-A01, € 220,-
- Bluetooth data interface for wireless data transfer to PC or tablets, must be ordered at purchase, not in combination with verification. When installing the Bluetooth data interface, the RS-232 data interface can no longer be used, KERN KFB-A03, € 160,-
- Analogue module, must be ordered at purchase, Analogue module 0-10 V, KERN KFB-A04, € 170,-
Analogue module 4-20 mA, KERN KFB-A05, € 170,-
- **5** Large display with superior display size, KERN YKD-A02, € 310,-
- Cable with special length 15 m, between display device and platform, for verified models which must be ordered at the time of purchase, KERN BFB-A03, € 198,-
- For further details, plenty of further accessories and suitable printers, see Internet

Note: For verified scales the weighing bridge must be fixed to the floor. Optionally, with an access ramp, a footplate pair or a pit frame.

1 Shipment via freight forwarder. Please ask for dimensions, gross weight, shipping costs-device on request.

Optionally configurable with IP68 display device on request, for details see chapter 13

STANDARD



OPTION



FACTORY

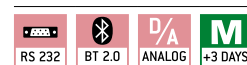

Model	Weighing capacity [Max] kg	Readability = Verification value [d] = [e] kg	Minimal load [Min] kg	Cable length of display device approx. m	Net weight approx. kg	Price excl. of VAT ex works €	Option			
							Verification KERN €	DAkKS KERN €	Calibr. Certificate DAKKS KERN €	
KERN NFN 600K-1M	600	0,2	4	5	105	4 170,-	965-230	150,-	963-130	196,-
KERN NFN 1.5T-4M	1500	0,5	10	5	105	4 140,-	965-230	150,-	963-130	196,-

Note: For applications that require verification, please order verification at the same time, initial verification at a later date is not possible. Verification at the factory, we need to know the full address of the location of use.

1 ONLY WHILE STOCKS LAST!

12 WEIGHING SYSTEMS INDUSTRY 4.0

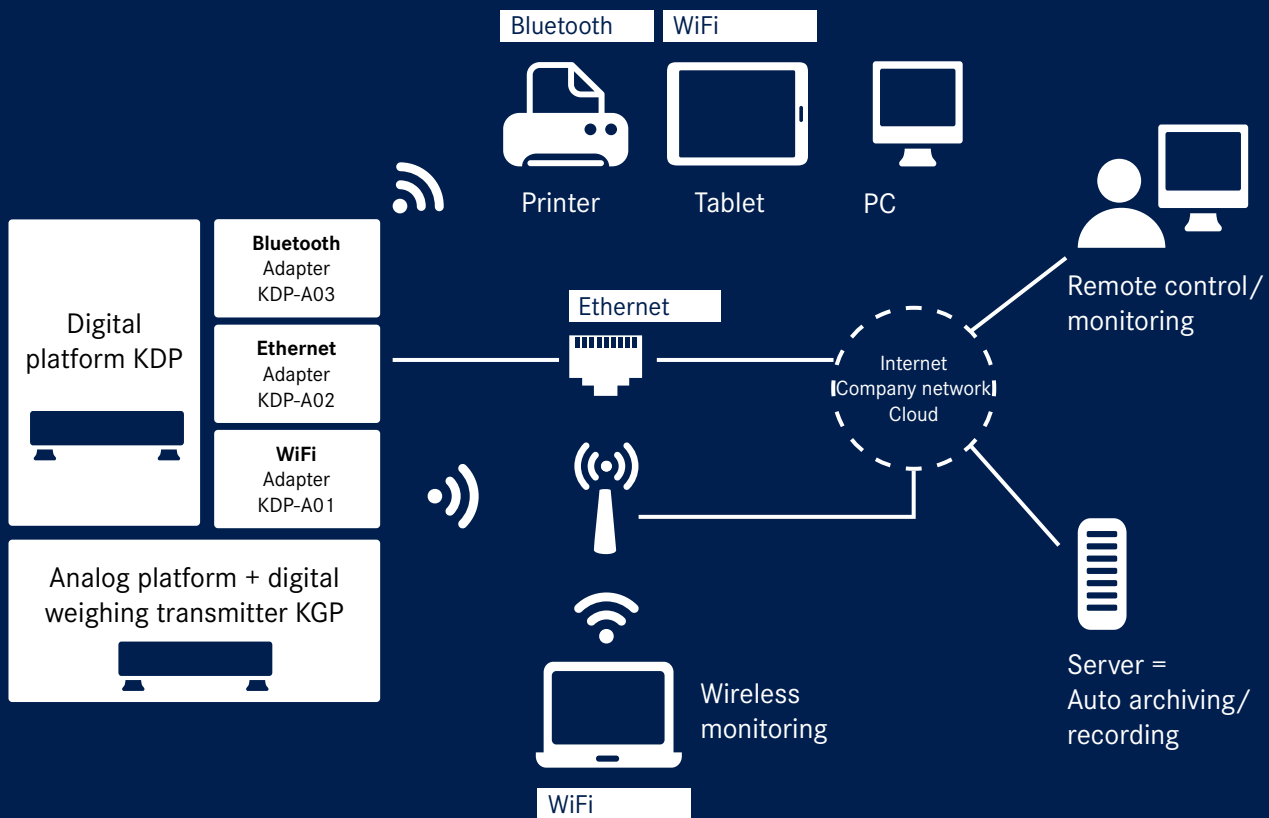

We will help to combine industrial production with the latest information and communication technology, with the aim of improving quality, reducing costs and using time and resources more efficiently so that you are able to react to future requirements in a more flexible manner. You will benefit from our uniform data protocol combined with our BalanceConnection 4.0 data software, for details please see page 174/175.

The KERN team in our centre of expertise – Industry 4.0



Daniel Egeler



Maximilian Pfister



Ralf Schmiege

We are happy to inform and advise you
Tel. +49 7433 9933-200, ITsupport@kern-sohn.com



Sim. to illustration

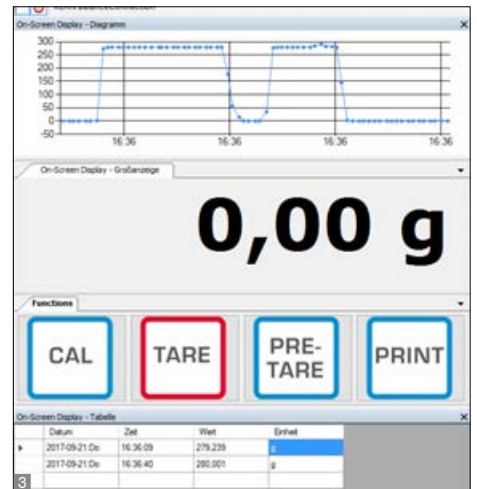

Robust industrial platform scale with digital weighing transmitter, ideal for varied range of applications for Industry 4.0

Features

- With this combination of platform 1 (KERN KFP V20 IP65) and digital weighing transmitter (KERN YKV-01) your weighing processes are ready for the requirements of Industry 4.0. Simply install the platform, connect the digital weighing transmitter to the network and start weighing
- For rapid transfer of weighing data to connected networks, computers, etc.
- USB and RS-232 data interface standard, Power supply via USB interface
- Transfer formats are freely configurable
- Digital weighing transmitter with standard Ethernet data interface on request
- Functions: Weighing, taring
- Internal resolution 16 million divisions
- Measuring frequency 10 Hz

- Easy configuration using the software supplied
- KERN YKV-01: Robust plastic die-cast housing
- 2 KERN YKV-01: Suitable for wall mounting and DIN track mount (optional)
- Included with the delivery:
 - Industrial platform KERN KFP
 - Digital weighing transmitter KERN YKV-01
 - 2 DIN rail mounting bracket for KERN YKV
 - Configuration software for adjusting and managing the KERN KGP, for large-format display of the values collected on the PC as well as transfer of this data to other Apps and programs. The displayed result can therefore be converted to any format for communication with the different user programs, such as, for example, e.g. SAP, Oracle etc.

Technical Data

- Weighing plate material: stainless steel
- KERN YKV-01: Overall dimensions W×D×H 100×140×36 mm
- Permissible ambient temperature -10 °C/ 40 °C

Accessories

- Bluetooth data interface, KERN YKV-A02, € 98,-
- WiFi interface, KERN YKV-A01, € 98,-
- Ethernet data interface on request
- 3 Software BalanceConnection, for flexible recording or transmission of measured values, in particular also to Microsoft® Excel or Access as well as transfer of this data to other Apps and programs, For more details see the internet, Scope of supplies: 1 CD, 1 license, KERN SCD-4.0, € 189,-

STANDARD



OPTION



FACTORY



Model	Weighing capacity [Max] kg	Read-out [d] g	Weighing plate W×D×H mm	Cable length approx. m	Net weight approx. kg	Price excl. of VAT ex works €	Options	
							DAkKS KERN	Calibr. Certificate €
KERN KGP 6K-4	6	0,2	230×230×120	2,5	6	460,-	963-128	112,-
KERN KGP 6K-4L	6	0,2	300×240×128	2,5	10	480,-	963-128	112,-
KERN KGP 10K-4	15	0,5	300×240×120	2,5	6	480,-	963-128	112,-
KERN KGP 10K-4L	15	0,5	400×300×128	2,5	10	520,-	963-128	112,-
KERN KGP 30K-3	30	1	300×240×120	2,5	6	480,-	963-128	112,-
KERN KGP 30K-3L	30	1	400×300×128	2,5	10	540,-	963-128	112,-
KERN KGP 60K-3	60	2	400×300×128	2,5	10	560,-	963-129	139,-
KERN KGP 60K-3L	60	2	500×400×137	2,5	14	620,-	963-129	139,-
KERN KGP 100K-3	150	5	500×400×137	2,5	14	620,-	963-129	139,-
KERN KGP 100K-3L	150	5	650×500×142	2,5	22	840,-	963-129	139,-
KERN KGP 300K-2L	300	10	650×500×142	2,5	22	890,-	963-129	139,-

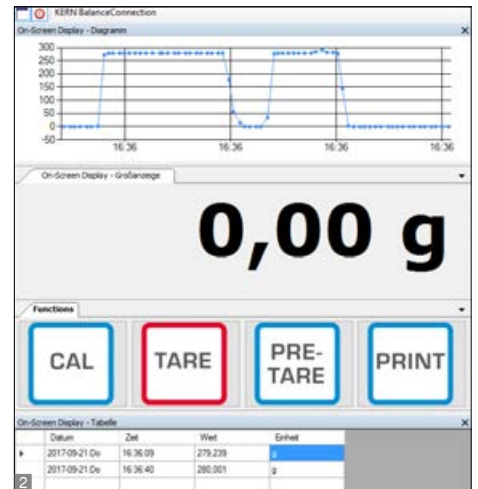

Modern digital weighing transmitter for the rapid recording of weighing data and forwarding it to the most varied output channels such as tablets, networks, SPS controllers, etc.
 – ideal for operating balances in systems or conveyors

Features

- With this digital weighing transmitter your weighing processes are ready for the requirements of Industry 4.0. Simply connect a weighing platform or load cell, integrate the digital weighing transmitter into the network and start weighing
- For rapid transfer of weighing data to connected networks, computers, etc.
- USB and RS-232 data interface standard, Power supply via USB interface
- Transfer formats are freely configurable
- Functions: Weighing, taring
- Measuring frequency 10 Hz
- Easy configuration using the software supplied
- Robust plastic die-cast housing

- **1** Suitable for wall mounting and DIN track mount
- Compatible with all KERN weighing platforms
- Included with the delivery:
 - Digital weighing transmitter KERN YKV-01
 - USB cable incl. mains plug
 - DIN rail mounting bracket
 - Configuration software for adjusting and managing, for large-format display of the values collected on the PC as well as transfer of this data to other Apps and programs. The displayed result can therefore be converted to any format for communication with the different user programs, such as, for example, e.g. SAP, Oracle etc

Technical Data

- Overall dimensions W×D×H 100×140×36 mm
- Net weight approx. 0,35 kg
- Permissible ambient temperature -10 °C/40 °C

Accessories

- Bluetooth data interface, KERN YKV-A02, € 98,-
- WiFi interface, KERN YKV-A01, € 98,-
- **2** Software BalanceConnection, for flexible recording or transmission of measured values, in particular also to Microsoft® Excel or Access as well as transfer of this data to other Apps and programs, For more details see the internet, Scope of supplies: 1 CD, 1 license, KERN SCD-4.0, € 189,-

STANDARD										FACTORY	
YKV-02											

Model	Standard interfaces	Price excl. of VAT ex works €
KERN YKV-01	RS-232, USB	265,-
KERN YKV-02	RS-232, USB, Ethernet	320,-

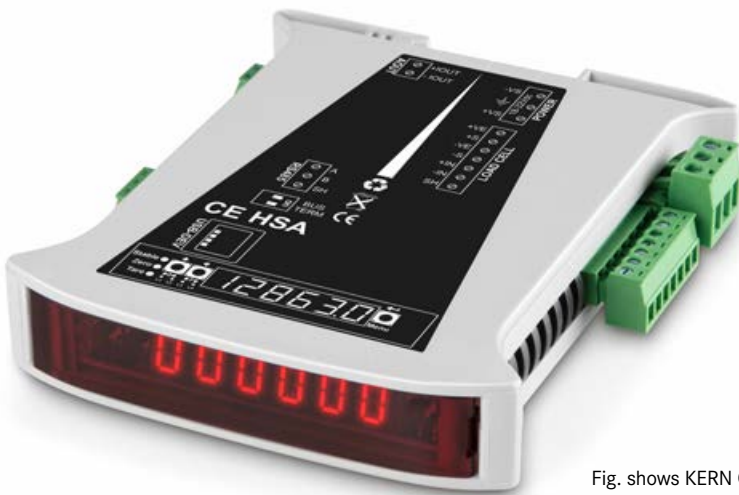

Fig. shows KERN CE HSA



Your contact for technical questions



Stefan Herrmann

Tel. +49 7433 9933-214
stefan.herrmann@kern-sohn.com

Super compact display device (rail-mounted module) for installation in switch cabinets

Features

- Compact display unit for recording weighing data using strain gauge load cells, e.g. in industrial applications
- Due to its small size, it is particularly space-saving to install in switch cabinets
- Thanks to the many interface variants, the modules can be ideally integrated into existing infrastructures and systems
- **A** The modules can be used either individually or as a Buslink system with a total of up to 332 DIN rail modules
- The configuration of the module can be carried out conveniently via a connected PC with the suitable software (Download see Internet)
- Bright LED display for optical control and settings
- Time-saving G-Cal™ (Geographic Calibration) technology for fast and accurate calibration without weights conveniently over a network or the Internet worldwide
- Convenient communication via remote devices
- Backup and restore function via USB port

- Can handle various industrial protocols such as Ethernet IP, Modbus TCP, Modbus RTU, FINS, PROFIBUS DP and PROFINET (according to model)
- Extremely high measurement frequency possible, up to 1600 data records/s
- Internal resolution 24 Bit

Technical Data

- 7 segment LED display, digit height 7,62 mm
- Dimensions W×D×H 120×101×23 mm
- Power supply 18-32 Vdc; 4 W max.
- Load cell power supply 5 Vdc
- Sensitivity 0,1 µV/d
- Adjustable nominal sensitivity: 1; 1.5; 2; 2.5; 3 mV/V
- Input voltage Unipolar @3mV/V: -1 mV to +16 mV
- Input voltage Bipolar @3mV/V: -16 mV to +16 mV
- Max. load cell impedance: 1200Ω
- Min. load cell impedance: 43,75 Ω
- Max. no. of load cells 350 Ω: 8
- Max. no. of load cells 1000 Ω: 22
- Max. number of d: 10.000

- Display steps: 1, 2, 5, 10, 20, 50, 100, 200
- Permissible ambient temperature -10 °C/40°C

Accessories

- Mains adapter for voltage supply to the KERN CE, can be fitted on the DIN rail, KERN CE HSS, **€ 90,-**
- Large display with superior display size, KERN YKD-A02, **€ 310,-**
- For further accessories, such as load and load cells, torque sensors and weighing platforms (strain gauge based only) from the SAUTER and KERN range, see www.sauter.eu
- Further accessories such as DIN rail, housing as well as individual assembly, configuration, adjustment, etc. on request

Note: Models also available with verification approval, please enquire

Model	Communication Interfaces	Digital I/O	Analog output	Price excl. of VAT ex works €
KERN				
CE HSA	USB	-	0/4-20/24mA	495,-
CE HSAIO <small>NEW</small>	USB	3 input/4 output	0/4-20/24mA	640,-
CE HSE	USB, Ethernet	3 input/4 output	-	560,-
CE HSP	USB, PROFIBUS	3 input/4 output	-	560,-
CE HSR	USB, RS232/422	3 input/4 output	-	530,-
CE HSN	USB, PROFINET	3 input/4 output	-	760,-

NEW New model

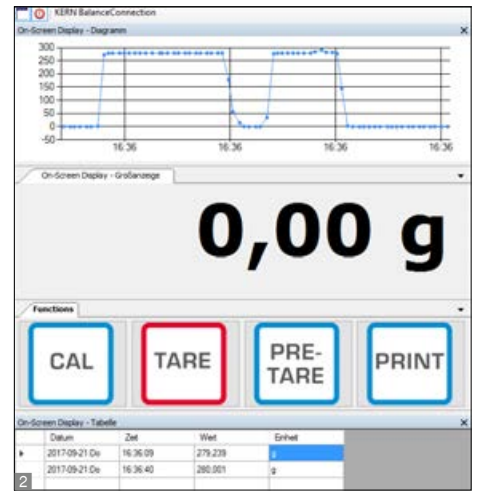

Universal weighing platforms for flexible connection into process chains

Features

- Industry 4.0 process chains: these weighing platforms can be easily integrated into your process chain. All recorded values can be easily transferred and processed further in your system as digital data and data that has already been compared using the many interfaces available. This saves cost, time and resources and ensures even more effective working
- Connecting the balance with a tablet or PC offers the advantage of being able to use the apps and programs which are on that device. These apps and programs are usually already tailored to your needs, are easy and convenient to use and can often be expanded as needed. This offers you the maximum level of flexibility when displaying, processing and saving the recorded weighing data
- Searching and remote control of the balance using external control devices or computers with the KERN Communication Protocol (KCP). KCP is a standardised interface command structure for KERN balances and other instruments which allows you to recall and manage

- all relevant parameters and device functions. You can therefore simply connect KERN devices with KCP to computers, industrial control systems and other digital systems. In a large number of cases the KCP is compatible with the MT-SICS protocol
- PRE-TARE function for manual subtraction of a known container weight, useful for checking fill-levels
- **1** A practical status LED informs about the active power supply
- Freely programmable weighing unit, e.g. display direct in special units such as length of thread g/m, paper weight g/m², or similar
- Draught shield standard for models with weighing plate size \varnothing 105 mm, weighing space WxDxH 146x146x80 mm
- Included with the delivery:
 - 2** Software BalanceConnection for adjusting and managing the KERN KDP, for large-format display of the values collected on the PC as well as transfer of this data to other Apps and programs

Technical Data

- Dimensions weighing surface
 - A** \varnothing 105 mm, plastic, with conductive lacquer
 - B** WxD 160x160 mm, stainless steel, see larger picture
- Overall dimensions WxDxH 165x166x75 mm (without draught shield)
- Cable length approx. 1,2 m
- Net weight approx. 1,2 kg
- Permissible ambient temperature 5 °C/35 °C

Accessories

- Bluetooth data interface for wireless data transfer to PC or tablets, must be ordered at purchase, KERN KDP-A03, **€ 54,-**
- WiFi data interface to transfer data from balances to PC or tablet, must be ordered at purchase, KERN YMI-A01, **€ 97,-**
- Ethernet data interface, to connect an IP-based Ethernet network, continuous data transfer, must be ordered at purchase, KERN KDP-A02, **€ 119,-**



Model	Weighing capacity [Max] g	Read-out [d] g	Reproducibility g	Linearity g	Weighing plate mm	Price excl. of VAT ex works €	Options	
							DAKkS KERN	Calibr. Certificate €
KDP 300-3	350	0,001	0,002	± 0,005	A	500,-	963-127	93,-
KDP 3000-2	3500	0,01	0,02	± 0,05	B	500,-	963-127	93,-
KDP 10K-4	10000	0,1	0,1	± 0,3	B	465,-	963-128	112,-
KDP 10K-3	10000	1	1	± 3	B	445,-	963-128	112,-

WE CAN MAKE YOUR WEIGHING DATA DIGITAL – KERN EASY TOUCH

The KERN EasyTouch software combines the performance of KERN scales with the flexibility of a Windows or Android environment.

The modular system solution for efficient weighing – perfect for your individual requirements



**See for yourself the many benefits of the new
KERN EasyTouch App:**

- Greater efficiency through short workflows for the user
- Greater security of the measuring results
- Avoiding measuring and process errors
- Unlimited master data memory
- Central data storage and data security (tamper-proof)
- Interfaces to ERP, PPS, etc. systems

 EasyTouch



See for yourself how
convenient and easy it is
to use KERN EasyTouch

All details about the new KERN EasyTouch App can be found at
www.kern-sohn.com/easytouch-app/en

Working with the KERN EasyTouch is so easy

Collect the weight and measurement data with the appropriate device

Transfer, process and agument the weight or measurement data through KERN EasyTouch

Output or store the weight or measurement data to connected systems or peripheral devices



- A standard balance is connected to an external laptop/tablet
- The performance of the balance is transferred to the terminal device 1:1

- Even simpler control and use of data by expanding the user interface
- The data is integrated directly in the process and this means it can continue to be used and stored

- Errors in the process or application are avoided
- In this way a simple balance becomes a highly-complex measuring device
- The recorded data can be processed further in a flexible way

The EasyTouch App – these functions are included:

- Operating system with Basic Weighing and Laboratory Package
- At present 14 optional add-on functions
- Data storage functions (local or cloud-based)
- On request we can also offer tailor-made solutions – get in touch with us

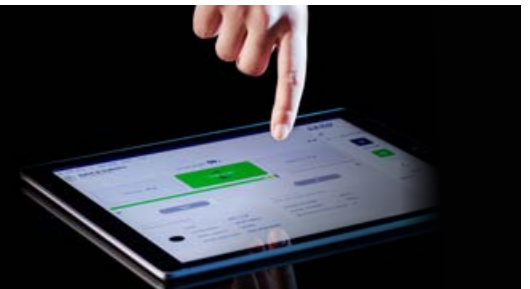

KERN EasyTouch App – download now from Microsoft Store® (for Windows®) or Google Play Store® (for Android™)



12

Test it without any risk and free of charge – it's that easy!

- 1 Load the basic App from the Appstore**
 The KERN EasyTouch App already contains many helpful functions.
- 2 Connect the devices you need**
 Connect to devices using the four interfaces provided (Bluetooth, wired or USB adapter or WiFi).
- 3 Test the basic package for 6 weeks, without obligation and free of charge**
 After 6 weeks you can decide whether to continue using the Apps. With absolutely no loss of data.

Talk to the professionals

Our KERN EasyTouch specialists will gladly inform and advise you on all questions regarding the new KERN EasyTouch App

Tel. +49 7433 9933-324
 Etsupport@kern-sohn.com



Daniel Egeler



Maximilian Pfister



Ina Reger



Albert Sauter

KERN EasyTouch – You have the following options



YOUR BENEFITS OF THE KERN EASYTOUCH SOFTWARE

- You only pay for the functions that you use
- Expansion of the range of services of your balance to meet your individual ideas and preferences
- Easy control of your balances from wherever you currently are: laboratory, production, office control of a PC, laptop or a tablet
- Tamper-proof storage of all weighing data on a central server, in an orderly database

Possible interfaces:

- Wired through RS 232 interface cable + USB adapter AFH 13
- Bluetooth through RS 232 interface cable + ET Connect Box YKI-14 Bluetooth
- Ethernet through RS 232 interface cable + YKI-01 Ethernet
- WLAN through RS 232 interface cable + YKI-03 WLAN

KERN EasyTouch – available right now for the following KERN ranges/models:

KERN BALANCES / WEIGHING PLATFORMS			SCALES FROM OTHER MANUFACTURERS	
440	EW/EG	KDP	PCD	Mettler-Toledo International Inc., USA, CH
572	EWJ	KFB-TM	PBS/PBJ	Minebea Intec GmbH, DE (ex Sartorius Industrie)
ABS/ABJ	FCB	KFC-TM	PES/PEJ	Ohaus Corp., USA
ADB/ADJ	FES/FEJ	KFN-TM	PLS/PLJ	Precisa Gravimetrics AG, CH
ALS/ALJ	FKB	KGP	PNS/PNJ	Radwag Wagy, PL
BFB	GAB	KIB-TM ⁽¹⁾	PWS	Sartorius AG, DE
BFN	IFB	KIC-TM	SFB	SysTec Systemtechnik/Industrieautomation GmbH, DE
BID ⁽¹⁾	IFS	KXS-TM	SXS	
CFS	IOC ⁽¹⁾	NFB	UFA	
CKE	IXS	NFN	UFB	
DS	KB	PCB	UID	

⁽¹⁾ Verified operation: Weighing data from legally regulated uses can be stored and archived in KERN EasyTouch in conformity with standards, by using models from this product family with valid calibration and measurement value memory. This standard-compliant data storage also applies to SaveServer and SaveCloud.

Depending on the model and connection type (USB, Bluetooth, Ethernet, WiFi), please contact KERN specifically, as there may currently still be restrictions on the possible combinations.

TIPP: Other KERN ranges can be adapted to be EasyTouch compatible – keep up-to-date with the latest new on www.kern-sohn.com/easytouch-app/en



Note: All KERN models which are EasyTouch compatible are marked with the relevant symbol in the catalogue!

EasyTouch function at a glance

Basic Package – Operating system

SET-01 ET OS

Basic Weighing & Laboratory Package

The basic package contains many useful functions such as weighing, totalizing, target dispensing and percentage weighing. As well as the local master data administration and management of the weighing results.

The basic package can be expanded at any time with additional, optional add-on functions.



Optional add-on functions

SET-07 ET Variable

Free variable function

Individually definable units, e.g. cable length g/m, weight per unit area g/m², etc.

SET-08 ET Take-Out

Take-out function

Ideal for portioning by removing from a source container

SET-11 ET Safety

Precision & Safety function

Scale monitoring: the MUST for the pharmaceutical sector

NEW

SET-16 ET Batch & Statistics

Batch measuring function with statistical analysis

Perfect function in the context of production control, for calculating averages, etc

SET-21 ET Formulation

Recipe function

Recipe management, dosing aid, recipe adjustment, multiplier function, etc.

SET-22 ET Difference

Difference function

Monitoring of weight increase (e.g. cell growth) or weight decrease (e.g. drying) and calculation of the weight difference

SET-31 ET Tolerance

Tolerance weighing function

Weighing within defined limits ensures fast sorting, portioning, picking, checking

SET-32 ET Count

Piece-counting function

Fast counting of large quantities, avoids counting errors, saves time and money!

SET-33 ET Target Count

Target-counting function

For lightning-fast picking of small parts, safely supported by optical and acoustic signals

SET-171 ET PrePack

Production control and packaging

Perfect for use in sectors such as the food industry for weighing in accordance with pre-packaging legislation

NEW

SET-14 ET Individual Print

User-customised print format function

Individual positioning of print elements, form printing, paper sizes and barcode printing is possible

NEW

You can find more functions on our EasyTouch home page:



www.kern-sohn.com/easytouch-app/en



Central data memory

SET-10 ET Save-Data Server

Weight storage and Save-Server function

Central storage of weighing and measuring data in a network

SET-101 Save-Data Cloud

Weight storage and Save-Server function in the cloud

Central storage of weighing and measuring data in the cloud, tamper-proof

13

DISPLAY DEVICES/ PLATFORMS/ WEIGHING BRIDGES

Customized individual weighing systems, without verification

KERN offers a range of KERN display devices and KERN weighing units, such as platform scales, floor scales, pallet scales and drive-through scales, which you can customize to make your ideal scale. You choose the components, KERN handles the rest.

Assembly

KERN delivers the complete scale which is ready to use. Prices for assembly can be found in the "Assembly" price table. On request we can also create a calibration certificate in accordance with DAkkS at an additional price, see page 210 ff.

Customizing individual weighing systems which can be verified or are verified

In order to provide the complete package, as well as assembling your individual weighing system, KERN will also carry out the manufacturer's initial verification/evaluation for conformity in accordance with EC directives as a commercial scales of verification class III.

In accordance with the European verification regulations, when assembling a display device with a weighing unit you must take the following notes into account:

- Only elements which can be verified with type approval or OIML test certificate can be combined into a weighing system which can be verified. Possible models are marked with "M".
- Platforms with load cells, provided as third-party products which have an OIML test certificate can be included.
- It will not be possible to carry out verification at a later date, e.g. after assembly and delivery of the weighing system. So please order the verification at the same time as you order the weighing system.

You will find a wide variety of display devices, platforms, weighing bridges, etc. in KERN's product range and these can be put together to create your ideal scale. You simply choose the components, KERN handles the rest.



The individual KERN steps:

	Weighing capacity	Model	Price excl. of VAT, ex works €
1. Proof of compatibility This is mandatory by law and includes testing by using type approvals, whether the connection values of the display device match the connection data of the weighing unit.	0 up ... kg	KERN	
	all Weighing capacities	965-240	49,-
2. Assembly After testing for suitability using the proof of compatibility, the weighing system will be hard wired by KERN. The weighing system will then be tested in accordance with regulations of 2014/31/EU, the European directive for non-automatic weighing instruments and prepared for conformity assessment.	up ≤ 50 kg	965-411	76,-
	up ≤ 350 kg	965-412	108,-
	up ≤ 1500 kg	965-413	130,-
	up ≤ 2900 kg	965-414	162,-
	up ≤ 6000 kg	965-415	270,-
	3. Initial verification by the manufacturer Conformity assessment ("Initial verification by the manufacturer") KERN is authorised to carry out the conformity assessment ("initial verification by the manufacturer") in accordance with 2014/31/EU, the European directive for non-automatic weighing instruments and is therefore authorised to introduce the weighing system onto the market, after the test has been carried out successfully and the conformity mark has been affixed.	up ≤ 5 kg	965-227
up ≤ 50 kg		965-228	80,-
up ≤ 350 kg		965-229	105,-
up ≤ 1500 kg		965-230	150,-
up ≤ 2900 kg		965-231	170,-
up ≤ 6000 kg		965-232	225,-
4. Declaration of conformity KERN issues this after the initial verification by the manufacturer Conformity assessment has been carried out successfully and sends it with the weighing system at no additional cost, and it can be used in areas regulated by law.			

Modifications and special services

Description	Model	Price excl. of VAT, ex works €
	KERN	
Cable extensions for platform scales		
up to 4 m extension	965-403	49,-
up to 7 m extension	965-404	65,-
up to 20 m extension	965-405	81,-
Individual settings		
Scale with NAWI conformity evaluation, only in combination with KERN 965-240	965-401	54,-
Other adjustments in the balance or software changes	965-407	103,-/h
Plug connection (replaces the fixed cable connection between the display device and platform with a plug connection which can be disconnected)		
Balances with type approval and verification (according to time spent)		only possible with separable, verifiable plug connection with identification chip (e.g. KERN KIB-A12), for the corresponding models (e.g. IOC, BID, UID) please order when purchasing
Balances with type approval, no verification	965-406	65,-

 Delivery time for modifications & special services approx. 5-8 working days

Order example

	Model	Price excl. of VAT, ex works €
KFP 30V20M platform and KEN-TM display device with cable extension (4 m) and setting an individual preload.	KERN	
KERN platform	KFP 30V20M	350,-
KERN display device	KFN-TM	390,-
Proof of compatibility	965-240	49,-
Cable extension	965-403	49,-
Setting the preload	965-401	54,-
Assembly	965-411	76,-
Verification at the factory KERN	965-228	80,-
Complete scale (verified)		1048,-

NOTHING IS IMPOSSIBLE – KERN CUSOS

Perfectly working weighing solutions with customized platform sizes, specific software solutions and coordinated peripherals - to suit your processes.

Our KERN Customized Solution Service offers maximum freedom of choice - give it a try.

KERN CUSOS – Perfectly tailored to you and your requirements

Powerful balances and efficient weighing systems which support you in your work, should be adapted to your individual requirements. Standard models are therefore not sufficient under some circumstances.

For this reason, at KERN it is our pleasure to work with you to develop a solution which is appropriate and tailor-made for you. From a range of platform sizes through to personalised weighing systems within large production plants, we can provide the right measuring technology.

Through close collaboration with your engineers and users, we first check the special requirements for your application. Using this data we will put together the appropriate platform scale, floor scale or a completely personalised weighing system for you, to fit your requirements perfectly.

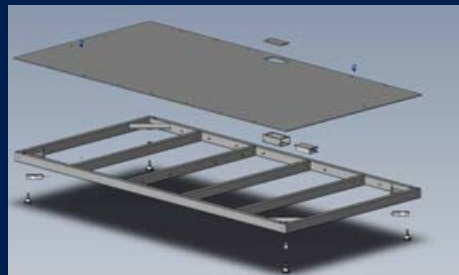

Our service for you: Individual weighing solutions

Fig.: Example of a design for personalised platform scales in the floor scale sector



Ideal for the most varied requirements, e.g. for weight measurement on roller conveyors in automation processes and packing stations

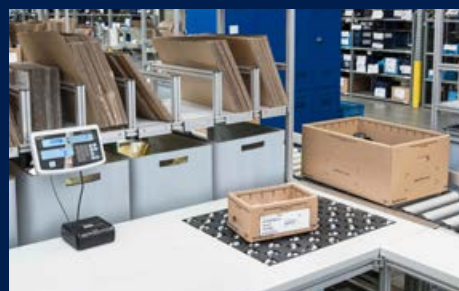

For perfect integration into existing and newly configured processes: individual platform construction in individual formats



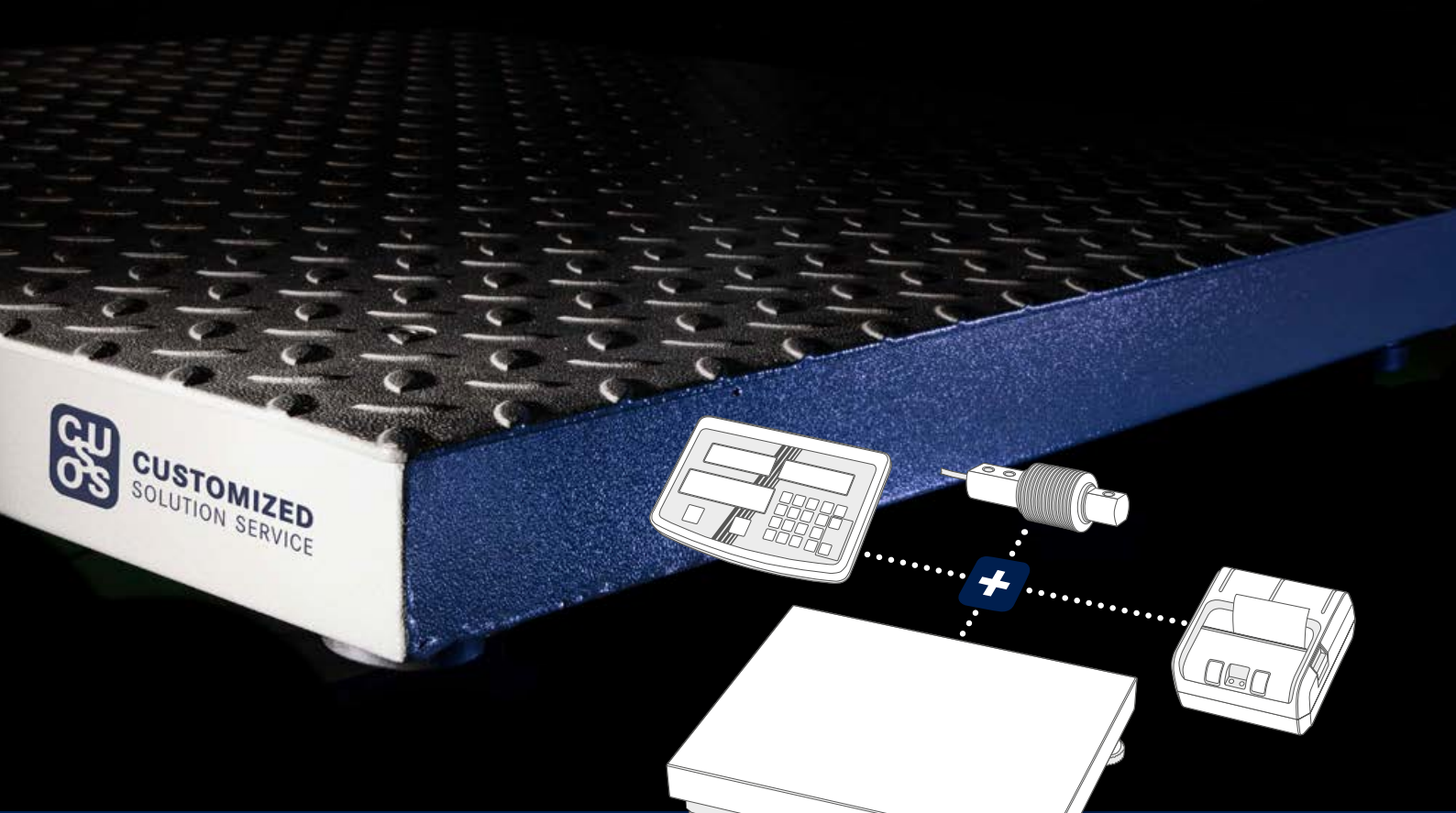

Your advantage - you have the choice

Choose from a wide range of display devices. Economical and lightweight (plastic version), robust and water-resistant (stainless steel version), with numeric key pad, battery or mains operation or the most varied interfaces.

Load cells to construct automatic weighing systems such as filling or dosing systems, such as might be used, for example, in manufacturing or filling processes in the chemical industry, construction industry, mineral industry, etc. On many occasions, load cells are also used in the construction of checkweighers or for installation into packaging machines of any type in the food industry.

The weighing data can be forwarded to peripheral devices such as signal lamps, printers and laptops or be used to switch valves, or similar devices.

What's your individual requirement?

Just tell us the size you want and the material you want for your platform and other essential construction details – done! We'll take care of the implementation.

From page 136 you will find a selection of our platforms, load cells and evaluation devices – the starting point for your individual system solution !



Tip: Save money and ask our experts. Maybe your desired combination is already included in our standard range?

Our competent CUSOS is at your disposal and is looking forward to your project:

Tel: +49 7433 9933-570

E-Mail: cusos@kern-sohn.com



Max Matthes



Fabian Brenner



Further information and products:
www.kern-sohn.com



1 KERN KFB-TM

Display device with large digits – easy to read and optional analogue output for controlling systems (PLC) etc.

2 KERN KFS-TM

Professional indicator with 3 displays, also with EC type approval [M]

Tip

to see what options are offered by this display device, please see the KERN platform scale IFB on page 106

Tip

to see what options are offered by this display device, please see the KERN counting scale IFS on page 86

STANDARD

CAL EXT RS 232 KCP GLP PCS SUM UNIT TOL

STANDARD OPTION FACTORY

MOVE MULTI 1 DAY ET ACCU BT 2.0 ANALOG M

STANDARD

CAL EXT MEMORY RS 232 KCP GLP INTERN PCS SUM

STANDARD OPTION FACTORY

TOL MULTI 1 DAY ET ACCU M

* not possible in combination with verification. When installing the Bluetooth data interface, the RS-232 data interface can no longer be used

** not possible in combination with signal lamp. When installing the analogue module, the RS-232 data interface can no longer be used

Features	Model KERN 1 KFB-TM	Model KERN 2 KERN KFS-TM
Display (segments)	5 + ½ digits	6 digits
EC type approval	yes	yes
Resolution verifiable	6000 e	3000 e
Resolution non verifiable	30000 d	60000 d
Weighing capacities	≤ 2	≤ 2
Weighing units	kg, lb	kg, g
Readability	1, 2, 5, 10, n	1, 2, 5, 10, n
Piece counting with reference	10, 20, 50, 100, 200	n
Display, digit height	Backlit LCD display, 52 mm	Backlit LCD displays, 13/16,5 mm
Additional functions	Totalising, HOLD function, Integrated KERN Communication Protocol (KCP), ideal for connecting an Merchandise Management or ERP system, Compatible with the KERN EasyTouch App	99 item memories, totalising, printing of date and time, Integrated KERN Communication Protocol (KCP), ideal for connecting an Merchandise Management or ERP system, Compatible with the KERN EasyTouch App
Strain gauge load cells	87 – 1600 Ω	87 – 1600 Ω
Linearisation	3 points	4 points
Input voltage	12 V, 500 mA	12 V, 500 mA
Permissible ambient temperature	-10 °C/40 °C	0 °C/40 °C
Interface RS-232	yes	yes
2. Interface RS-232, separate Y cable	CFS-A04, € 38,-	CFS-A04, € 38,-
Interface RS-485	-	-
Interface USB	-	-
Interface Bluetooth	KERN KFB-A03, see page 97, € 160,-	-
Analogue module	0-10V: KERN KFB-A04, € 170,-; 4-20 mA: KERN KFB-A05, € 170,-; see page 97	-
Signal lamp	CFS-A03, € 330,-	CFS-A03, € 330,-
Foot switch	-	-
Stand	BFS-A07, see page 97, € 170,-	BFS-A07, see page 78, € 170,-
Benchtop stand for display device/wall mount	yes/yes	yes/yes
Protective working cover	KFB-A02S05, see page 97, € 44,-	KFB-A02S05, see page 78, € 44,-
Rechargeable battery pack	KFB-A01, see page 97, € 40,-	KFB-A01, see page 78, € 40,-
Operating/charging time	up to 35 h/12 h	up to 40 h/12 h
Dimensions Housing W×D×H	250×160×65 mm	260×150×65 mm
Net weight	1,2 kg	1,5 kg
Price	260,-	280,-
excl. of VAT, ex works €		



3 KERN KIB-TM

Practical Flip/Flop display device for greatest ease of use

- Practical Flip/Flop display device: flexible positioning e.g. free-standing or screwed to the wall (optional). By rotating the upper housing shell you can determine the angle of the display as well as the cable outlet. Factory Option ex works for an additional cost, delivery time + 2 working days, KERN KIB-M01, € 104,-
- Industry 4.0: A large number of (optional) data interfaces enable convenient transferring weighing data to tablets, laptops, PCs, networks, smartphones, printers, etc.
- Searching and remote control of the balance using external control devices or computers with the KERN Communication Protocol (KCP).

4 KERN KFN-TM

Stainless steel display device with IP65 protection and superior display size and optional analogue output for controlling systems (PLC) etc.

Tip

to see what options are offered by this display device, please see the KERN SFB platform scale on page 71

STANDARD												OPTION						
FACTORY												STANDARD		OPTION		FACTORY		
						* Note: In addition to the RS-232 data interface, which is integrated as standard, only one other data interface can be installed and operated												

Features	Model KERN 3 KIB-TM	Model KERN 4 KFN-TM
Display (segments)	6 digits	5 + 1/2 digits
EC type approval	yes	yes
Resolution verifiable	6000 e	6000 e
Resolution non verifiable	60000 d	30000 d
Weighing capacities	≤ 2	≤ 2
Weighing units	kg, g	kg
Readability	1, 2, 5, 10, n	1, 2, 5, 10, n
Piece counting with reference	5, 10, 20, 25, 50, 100	10, 20, 50, 100, 200
Display, digit height	Backlit LCD display, 24 mm	Backlit LCD display, 52 mm
Additional functions	Totalising, HOLD function, printing of time. KCP Only possible through RS-232; USB, Bluetooth, WiFi, Digital I/O, LAN on request	Totalising, HOLD function
Strain gauge load cells	87-1100 Ω	87 - 1600 Ω
Linearisation	3 points	3 points
Input voltage	12 V DC, 1000 mA	12 V, 500 mA
Permissible ambient temperature	-10 °C/40 °C	-10 °C/40 °C
Interface RS-232	yes*	KFN-A01, see page 62, € 220,-
Interface RS-485	-	-
Interface USB	KIB-A03*, see page 102, € 120,-	-
Interface Bluetooth	KIB-A04*, see page 102, € 110,-	-
WiFi	KIB-A10*, see page 102, € 130,-	-
SWITCH (DIGITAL I/O)	-	-
LAN	KIB-A02*, see page 102, € 165,-	-
Alibi memory	KIB-A01, € 175,-	-
Analogue module	-	0-10V: KERN KFB-A04, € 170,-; 4-20 mA: KERN KFB-A05, € 170,-; see page 97
Stand	EOC-A05, see page 102, € 70,-	BFS-A07, see page 62, € 170,-
Benchtop stand for display device/wall mount	EOC-A04, € 33,-	yes/yes
Protective working cover	EOC-A01S05, € 55,-	-
Rechargeable battery pack	KFB-A01, see page 102, € 40,-	GAB-A04, € 42,-
Operating/charging time	up to 43 h/3 h	up to 35 h/12 h
Dimensions Housing W×D×H	268×115×70 mm	266×165×96 mm
Net weight	0,8 kg	2,6 kg
Price excl. of VAT, ex works €	220,-	390,-

- * not possible in combination with verification. When installing the Bluetooth data interface, the RS-232 data interface can no longer be used
- ** not possible in combination with signal lamp. When installing the analogue module, the RS-232 data interface can no longer be used



Other platform sizes, special construction, individual scale construction according to your individual requirements, also possible with third-party components, please enquire

1 KERN KFP-V20 IP65

Platform

STANDARD FACTORY

IP 65 1 DAY 2 DAYS KFP 600

M

- Stainless steel-weighing plate, **A** Painted steel base
- 1 load cell, aluminium, silicone-coated, IP65, OIML-R60-approved, class III, 3000 e
- Level indicator and levelling feet for precise levelling of the scale

2 KERN KXP-V20 IP65

Platform

STANDARD FACTORY

IP 65 1 DAY

M

- Stainless steel-weighing plate, **B** Painted steel base, extremely rigid, wing design
- 1 load cell, aluminium, silicone-coated, IP65, OIML-R60-approved, class III, 3000 e
- Level indicator and levelling feet for precise levelling of the scale



Model	Weighing range [Max] kg	Readability [d] g	Verification value [e] g	Min. load [Min] g	Cable length approx. m	Net weight approx. kg	Weighing plate W×D×H mm	Price excl. VAT, ex works €
1 Platform KFP-V20 IP65								
KFP 3V20M	3	0,1	1	20	2,5	3,6	230×230×105	205,-
KFP 6V20M	6	0,2	1 2	40	2	3,6	230×230×105	205,-
KFP 6V20LM	6	0,2	1 2	40	2,5	6	300×240×105	275,-
KFP 15V20M	15	0,5	2 5	100	2	6	300×240×105	280,-
KFP 15V20LM	15	0,5	2 5	100	2,5	10	400×300×125	350,-
KFP 30V20SM	30	1	10	200	2,5	6	300×240×105	275,-
KFP 30V20M	30	1	5 10	200	2	10	400×300×125	350,-
KFP 60V20M	60	2	10 20	400	2	10	400×300×125	355,-
KFP 60V20LM	60	2	10 20	400	2	10	500×400×130	450,-
KFP 150V20M	150	5	20 50	1000	2	10	500×400×130	460,-
KFP 150V20LM	150	5	20 50	1000	2	22	650×500×135	670,-
KFP 300V20M	300	10	50 100	2000	2	22	650×500×135	670,-
KFP 600V20AM	600	20	200	4000	2,5	46	800×600×190	1010,-
2 Platform KXP-V20 IP65								
KXP 6V20LM *	6	0,2	1 2	40	3	3,2	300×240×90	340,-
KXP 15V20M *	15	0,5	2 5	100	3	3,2	300×240×90	350,-
KXP 15V20LM *	15	5	5	100	3	8	400×300×90	460,-
KXP 30V20M *	30	1	5 10	200	3	8	400×300×90	460,-
KXP 30V20LM *	30	1	5 10	200	3	18	500×400×123	630,-
KXP 60V20M *	60	2	10 20	400	3	11	400×300×90	480,-
KXP 60V20LM *	60	2	10 20	400	3	22	500×400×123	630,-
KXP 150V20M *	150	5	20 50	1000	3	18	500×400×123	630,-
KXP 150V20LM *	150	5	20 50	1000	3	34	650×500×133,5	770,-
KXP 300V20M *	300	10	50 100	2000	3	34	650×500×133,5	770,-

* ONLY WHILE STOCKS LAST!

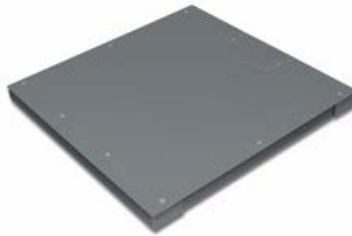
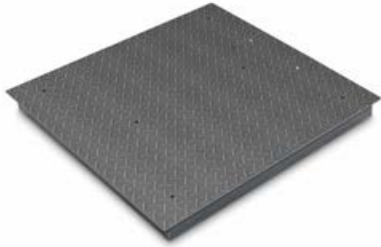

3 KERN KIP-V20M

Weighing bridge



- Weighing bridge with non-slip chequer plate, lacquered, welded
- 4 Load cells, steel, silicone-coated, IP67, OIML-R60-approval for verification, class III, 3000 e
- Can be built in using pit frames (optional)
- Level indicator and levelling feet for precise levelling of the scale
- Easy access to the junction box from the top
- Comfortable levelling of the weighing bridge from the top
- Accessories see KERN BID, page 114/115

4 KERN KFP-V20 IP67

Weighing bridge



- **C** Weighing plate screwed on from the top (models with [Max] ≤ 1500 kg), so it easy to remove, hygienic and easy to clean.
- Lacquered steel weighing bridge, weighing plate size 1500×1500×130 mm corrugated steel plate. Extremely resistant to bending due to material thickness
- 4 Load cells, steel, silicone-coated, IP67, OIML-R60-approval for verification, class III, 3000 e
- Can be built in using pit frames (optional)
- Level indicator and levelling feet for precise levelling of the scale
- Easy access to the junction box from the top
- Comfortable levelling of the weighing bridge from the top
- Accessories see KERN BFB, page 116/117

5 KERN KFD-V20

Weighing bridge



- Weighing bridge made of non-slip corrugated steel plate, lacquered, two access ramps integrated, extremely resistant to bending
- Extremely flat construction to facilitate access: access height only 45 mm
- 4 Load cells, alloy steel, silicone-coated, IP67, OIML-R60-approved class III, 3000 e
- Accessories see KERN NFB page 125



Model	Weighing range [Max] kg	Readability [d] g	Verification value [e] g	Min. load [Min] g	Cable length approx. m	Net weight approx. kg	Weighing plate W×D×H mm	Price excl. VAT, ex works €
3 Weighing bridge KIP-V20M								
KIP 600V20SM	600	200	200	4000	5	130	1000×1000×108	1280,-
KIP 600V20M	600	200	200	4000	5	150	1500×1200×108	1710,-
KIP 1500V20SM	1500	500	500	10000	5	130	1000×1000×108	1290,-
KIP 1500V20EM	1500	500	500	10000	5	140	1200×1000×108	1390,-
KIP 1500V20M	1500	500	500	10000	5	150	1500×1200×108	1710,-
KIP 3000V20M	3000	1000	1000	20000	5	150	1500×1200×108	1710,-
KIP 3000V20LM	3000	1000	1000	20000	5	180	1500×1500×108	2030,-
4 Weighing bridge KFP-V20 IP67								
KFP 600V20SNM	600	200	200	4000	5	105	1000×1000×80	1590,-
KFP 600V20NM	600	200	200	4000	5	135	1500×1250×80	2240,-
KFP 1500V20SNM	1500	500	500	10000	5	105	1000×1000×80	1580,-
KFP 1500V20NM	1500	500	500	10000	5	135	1500×1250×90	2250,-
KFP 3000V20NM	3000	1000	1000	20000	5	135	1500×1250×90	2250,-
KFP 3000V20LNM	3000	1000	1000	20000	5	155	1500×1500×80	2520,-
KFP 6000V20M	6000	2000	2000	40000	5	210	1500×1500×130	3000,-
5 Weighing bridge KFD-V20								
KFD 600V20M	600	200	200	4000	5	125	1600×1200×78	2210,-
KFD 600V20LM	600	200	200	4000	5	155	1800×1400×80	2590,-
KFD 1500V20M	1500	500	500	10000	5	125	1600×1200×78	2210,-
KFD 1500V20LM	1500	500	500	10000	5	175	1800×1400×78	2590,-

6 KERN KFA-V20

Weighing beams

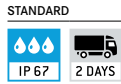

- Weighing beams and painted steel base
- 4 load cells, alloy steel, silicone-coated, IP67
- Levelling feet for precise levelling of the weighing beams
- Connection cable, length 5 m
- **D** Image below: Version up to 6 t available. Each weighing beam has a roller and handle for easy transport of the scale (KERN KFA-L)
- **Special feature:** model with short weighing beams, ideal for weighing compact items or animals in transport boxes
 - ▶ KERN KFA-600V20S
- Accessories see KERN UFA, page 119

7 KERN KFU-V20/V30

U-Weighing bridge



- Load range: painted steel (V20), stainless steel (V30) height 90 mm
- 4 load cells, alloy steel, silicone-coated, IP67, OIML-R60-approval for verification, class III, 3000 e
- 2 rollers and handle for easy transport of the scale
- Accessories KFU-V20 see KERN UFB, page 122
- Accessories KFU-V30 see KERN UFN, page 123

8 KERN KFP-V30

Platform



- Stainless steel-weighing plate, **E** Stainless steel substructure
- 1 load cell, Stainless steel, silicone-coated, IP67, OIML-approved, class III, 3000 e
- Level indicator and levelling feet for precise levelling of the scale



Model	Weighing range [Max] kg	Readability [d] g	Verification value [e] g	Min. load [Min] g	Cable length approx. m	Net weight approx. kg	Weighing plate W×D×H mm	Price excl. VAT, ex works €
6 Weighing beams KFA-V20								
KFA 600V20S	600	200	-	-	5	30	800×120×100	970,-
KFA 1500V20	1500	500	-	-	5	36	1200×120×100	1100,-
KFA 3000V20	3000	1000	-	-	5	36	1200×120×100	1250,-
KFA 3000V20L	3000	1000	-	-	5	65	2000×120×100	1590,-
KFA 6000V20	6000	2000	-	-	5	85	1200×160×80	1660,-
KFA 6000V20L	6000	2000	-	-	5	125	2100×160×85	2180,-
7 U-Weighing bridge KFU-V20								
KFU 600V20M	600	200	200	4000	5	55	840×1350×90	1510,-
KFU 1500V20M	1500	500	500	10000	5	55	840×1350×90	1460,-
7 Stainless steel U-Weighing bridge KFU-V30								
*	600	200	200	4000	5	55	840×1350×90	1919,-
KFU 1500V30M*	1500	500	500	10000	5	55	840×1350×90	1910,-
8 Stainless steel platform KFP-V30								
KFP 15V30M	15	0,5	5	100	2,5	5,0	300×240×100	700,-
KFP 30V30SM	30	10	10	200	2,5	5,0	300×240×100	690,-
KFP 30V30M	30	1	10	200	2,5	10	400×300×128	760,-
KFP 60V30M	60	2	20	400	2,5	10	400×300×128	760,-
KFP 60V30LM	60	2	20	400	2,5	10	500×400×137	950,-
KFP 60V30XLM	60	2	20	400	2,5	22	650×500×142	1370,-
KFP 150V30SM	150	5	50	1000	2,5	10	400×300×128	760,-
KFP 150V30M	150	5	50	1000	2,5	10	500×400×137	940,-
KFP 150V30LM	150	5	50	1000	2,5	22	650×500×135	1370,-
KFP 300V30M	300	10	100	2000	2,5	22	650×500×135	1280,-

* ONLY WHILE STOCKS LAST!



9 KERN KFP-V40

Weighing bridge

STANDARD FACTORY

IP 68 2 DAYS M

- Weighing bridge entirely made of stainless steel, extremely resistant to bending because of its high material thickness
- **F** Weighing plate fixed with stainless steel screws, for easier access to the loadcells from above
- 4 load cells, stainless steel, encapsulated, IP68, OIML-R60-approved, class III, 3000 e
- Can be built in using pit frames (optional)
- Level indicator and levelling feet for precise levelling of the scale
- Comfortable levelling of the weighing bridge from the top
- Accessories see KERN BFN, page 118

10 KERN KFD-V40

Weighing bridge

STANDARD FACTORY

IP 68 2 DAYS M

- Weighing bridge made from stainless steel, two integrated access ramps, extremely resistant to bending
- Extremely flat construction to facilitate access: access height only 45 mm
- 4 load cells, stainless steel, encapsulated IP68, OIML-R60-approval for verification, class III, 3000 e
- Level indicator and levelling feet for precise levelling of the scale
- Accessories see KERN NFN, page 126



Model	Weighing range [Max]	Readability [d]	Verification value [e]	Min. load [Min]	Cable length approx.	Net weight approx.	Weighing plate W×D×H mm	Price excl. VAT, ex works €
9 Stainless steel weighing bridge KFP-V40								
KFP 600V40SM	600	200	200	4000	5	95	1000×1000×80	3180,-
KFP 1500V40M	1500	500	500	10000	5	135	1500×1250×80	4000,-
KFP 1500V40SM	1500	500	500	10000	5	95	1000×1000×80	3180,-
KFP 3000V40M	3000	1000	1000	20000	5	135	1500×1250×80	4540,-
10 Stainless steel weighing bridge KFD-V40								
KFD 600V40M	600	200	200	4000	5	130	1600×1200×78	4080,-
KFD 1500V40M	1500	500	500	10000	5	130	1600×1200×78	4050,-

13 LOAD CELLS

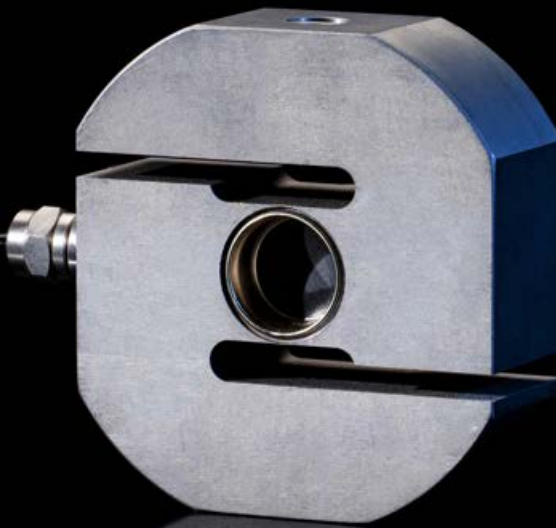

Accuracy classes with nominal loads from 300 g to 100 t and protection classes up to IP69K as well as cells protected according to ATEX or OIML approved cells are available to you from now in the SAUTER product range. Whatever the project – whether it's the development of customised weighing systems, installation in silos and storage tanks or in shelving for continuous inventory, for special application in mechanical engineering or in any type of test bench – SAUTER can offer you just the right load cell.

Any special requests? Do you need special load cells, other capacities or cable lengths, individual force test benches or a special mount for your test item? No problem, our product specialist for force-load cells Mr Stefan Herrmann is available at any time to help you further and will work with you to develop a customised concept for your application.

Of course, we can also supply you with the appropriate accessories such as load corners, pivot heads, display devices, junction boxes or the relevant calibration certificate at the same time.



Stefan Herrmann
Product specialist Load cells

Tel. +49 7433 9933-214
stefan.herrmann@kern-sohn.com

BALANCE MANUFACTURE

Load cell + Junction Box + KERN YKV

FORCE MEASUREMENT

Load cell + SAUTER FL + Software

BALANCE MANUFACTURE

Load cell + display device

BALANCE MANUFACTURE

Load cell + KERN YKV +
KERN Software BalanceConnection

BALANCE MANUFACTURE

Load cell + Junction Box
+ display device

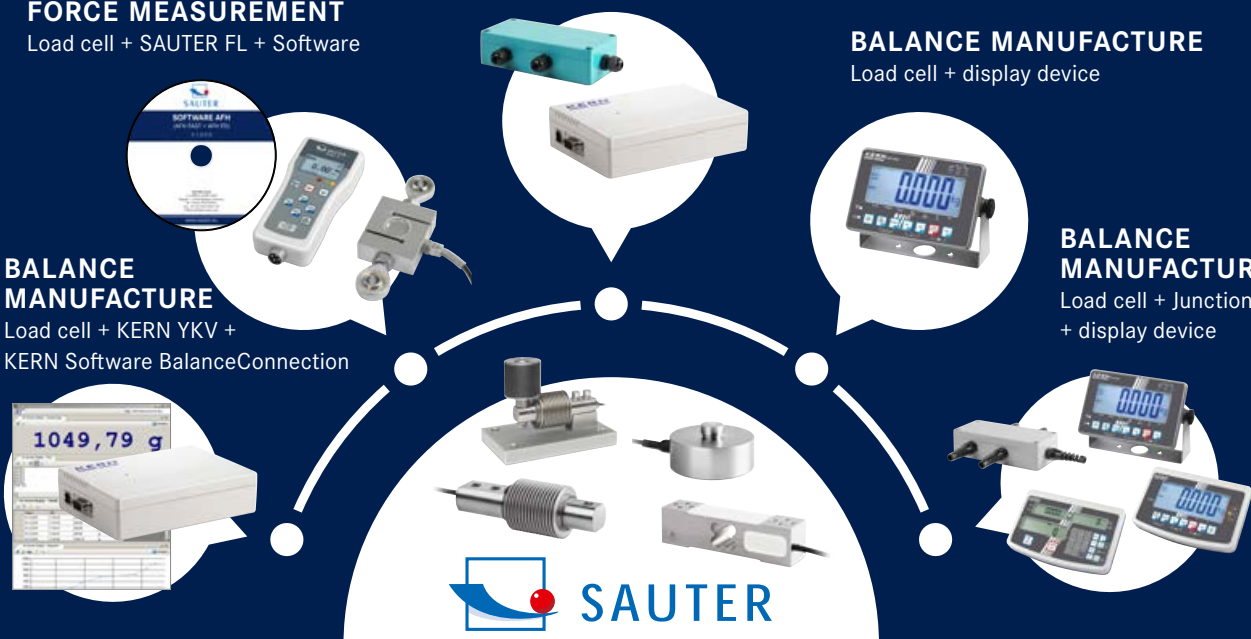

SAUTER load cells – integration opportunities



CP P4 · CP Y4

Single-point load cells made of anodised aluminium

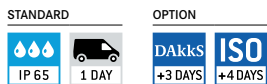

- CP P4: Accuracy in accordance with OIML R60 C3
- CP Y4: Accuracy in accordance with OIML R60 C2
- CE and RoHS compliant
- Dust and spray protection to IP65 (in accordance with EN 60529)
- Aluminium, anodised
- Suitable for price-computing scales, bench scales, platform scales, etc.
- Maximum platform size 200×200 mm
- 4-wire connection
- Nominal sensitivity: 0,9 mV/V

Model	Nominal load	Price excl. of VAT ex works
SAUTER	kg	€
CP 300-0P4	0,3	65,-
CP 600-0P4	0,6	65,-

Model	Nominal load	Price excl. of VAT ex works
SAUTER	kg	€
ECO design		
CP 300-0Y4	0,3	55,-
CP 1500-0Y4	1,5	55,-
CP 3000-0Y4	3	55,-

CP P1 · CP Y1

Single-point load cells made of anodised aluminium



- CP P1: Accuracy in accordance with OIML R60 C3
- CP Y1: Accuracy in accordance with OIML R60 C2
- CE and RoHS compliant
- Dust and spray protection to IP65 (in accordance with EN 60529)
- Aluminium, anodised
- Suitable for price-computing scales, bench scales, platform scales, etc.
- Maximum platform size 250×350 mm
- 4-wire connection
- Nominal sensitivity: 2 mV/V
- Note: Version in accordance with OIML R60 C4 or C5 on request

Model	Nominal load	Price excl. of VAT ex works
SAUTER	kg	€
CP 3-3P1	3	60,-
CP 5-3P1	5	60,-
CP 6-3P1	6	60,-
CP 8-3P1	8	60,-
CP 10-3P1	10	60,-
CP 15-3P1	15	60,-
CP 20-3P1	20	60,-
CP 30-3P1	30	60,-
CP 35-3P1	35	60,-
CP 40-3P1	40	60,-
CP 50-3P1	50	60,-

Model	Nominal load	Price excl. of VAT ex works
SAUTER	kg	€
ECO design (without EC type approval)		
CP 3-2Y1	3	33,-
CP 5-2Y1	5	33,-
CP 10-2Y1	10	33,-
CP 15-2Y1	15	33,-
CP 20-2Y1	20	33,-
CP 30-2Y1	30	33,-

CP P3

Single-point load cells made of anodised aluminium



- Accuracy in accordance with OIML R60 C3
- CE and RoHS compliant
- Dust and spray protection to IP65 (in accordance with EN 60529)
- Suitable for price-computing scales, bench scales, platform scales, etc.
- Maximum platform size 350×400 mm
- 4-wire connection
- Nominal sensitivity: 2 mV/V
- Note: Version in accordance with OIML R60 C4 on request

Model	Nominal load	Price excl. of VAT ex works
SAUTER	kg	€
CP 30-3P3	30	76,-
CP 40-3P3	40	76,-
CP 50-3P3	50	76,-
CP 75-3P3	75	76,-
CP 100-3P3	100	77,-

NEW New model

Tip

Further details and technical data sheet as well as extensive accessories can be found online at www.kern-sohn.com



CP P2 · CP P8

Single-point load cells of aluminium

STANDARD
 IP 65 1 DAY

OPTION
 DAKkS ISO
 +3 DAYS +4 DAYS

- Accuracy in accordance with OIML R60 C3
- RoHS compliant
- Dust and spray protection to IP65 (in accordance with EN 60529)
- Aluminium, anodised
- Suitable for price-computing scales, bench scales, etc.
- Maximum platform size 100–300 kg: 400×400 mm
- Maximum platform size 400–500 kg: 450×450 mm
- Nominal sensitivity: 2 mV/V
- Note: Version in accordance with OIML R60 C4 or C5 on request

CP P7

Single-point load cells of stainless steel

STANDARD
 IP 67 1 DAY

OPTION
 DAKkS ISO
 +3 DAYS +4 DAYS

- Accuracy in accordance with OIML R60 C3
- RoHS compliant
- Dust and spray protection to IP67 (in accordance with EN 60529)
- Stainless steel
- Application example: Weight as well as compressive force measurements under harsh environmental conditions
- Suitable for bench scales, price-computing scales
- Maximum platform size 400×400 mm
- 6-wire connection
- Nominal sensitivity: 2 mV/V
- Note: Version in accordance with OIML R60 C4 on request

CP P9

Single-point load cells of stainless steel

STANDARD
 IP 68 IP 69K M 1 DAY

OPTION
 DAKkS ISO
 +3 DAYS +4 DAYS

- Accuracy in accordance with OIML R60 C3
- RoHS compliant
- Dust and spray protection to IP68/IP69K (in accordance with EN 60529 resp. ISO 20653), welded to create a hermetic seal
- Stainless steel
- Area of application: Weight measurement as well as compressive force in harsh environments
- Suitable for platform scales, checkweighers
- Maximum platform size 10–50 kg: 400×400 mm
- Maximum platform size 100–500 kg: 800×800 mm
- 4-wire connection (10–50 kg)
- 6-wire connection (100–500 kg)
- Nominal sensitivity: 2 mV/V
- Note: Version in accordance with OIML R60 C4 or C5 on request

13

Model	Nominal load	Price
	kg	excl. of VAT ex works €
SAUTER		
CP 100-3P2	100	81,-
CP 150-3P2	150	81,-
CP 200-3P2	200	81,-
CP 300-3P2	300	81,-
CP 400-3P2	400	81,-
CP 500-3P2	500	81,-
CP 100-3P8	50	123,-
CP 150-3P8	100	123,-
CP 200-3P8	150	123,-
CP 250-3P8	200	123,-
CP 300-3P8	250	123,-
CP 500-3P8	300	123,-
CP 50-3P8	500	123,-
CP 600-3P8	600	123,-

New model

Tip

- Further details and technical data sheet as well as extensive accessories can be found online at www.kern-sohn.com

Model	Nominal load	Price
	kg	excl. of VAT ex works €
SAUTER		
CP 30-3P7	30	270,-
CP 50-3P7	50	270,-
CP 75-3P7	75	270,-
CP 100-3P7	100	270,-
CP 150-3P7	150	270,-

Model	Nominal load	Price
	kg	excl. of VAT ex works €
SAUTER		
CP 10-3P9	10	380,-
CP 20-3P9	20	380,-
CP 50-3P9	50	380,-
CP 100-3P9	100	570,-
CP 200-3P9	200	580,-
CP 300-3P9	300	580,-
CP 400-3P9	400	580,-
CP 500-3P9	500	580,-



Fig. shows accessories, load corner SAUTER CE Q42901, for further accessories please visit our online shop

CR Q1

Load cells made of stainless steel

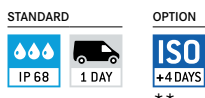

- Accuracy in accordance with OIML R60 C1
- RoHS compliant
- Dust and spray protection to IP68 (in accordance with EN 60529), hermetically encapsulated
- Stainless steel
- Area of application: Weight measurement as well as compressive force
- Suitable for vehicle scales, weigh hoppers, vehicle testing equipment, test benches
- Nominal sensitivity: 2 mV/V

CR P1

Load cells made of stainless steel

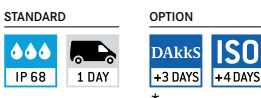

- Accuracy in accordance with OIML R60 C3
- RoHS compliant
- Dust and spray protection to IP68 (in accordance with EN 60529), hermetically encapsulated
- Stainless steel
- Area of application: Weight measurement as well as compressive force
- Suitable for truck scales, suspended scales, silo scales and other diverse scales, test benches, etc.
- Nominal sensitivity: 1-2 mV/V

Accessories CR Q1:

- Load corner, steel, galvanised, suitable for CR Q1 with nominal load ≤ 10 t, SAUTER CE Q42901, € 265,-
- Load corner, steel, galvanised, suitable for CR Q1 with nominal load ≥ 20 t, SAUTER CE Q42902, € 420,-
- Load corner, steel, rustproof, suitable for CR Q1 with nominal load ≤ 10 t, SAUTER CE RQ42901, € 475,-
- Load corner, steel, rustproof, suitable for CR Q1 with nominal load ≥ 20 t, SAUTER CE RQ42902, € 810,-

Accessories CR P1:

- Load corner for CR 1000-3P1, CR 250-3P1, CR 500-3P1 Steel, incl. pressure piece, SAUTER CE P244011, € 600,-
- Pressure piece for CR 1000-3P1, CR 250-3P1, CR 500-3P1 steel, SAUTER CE P244012, € 115,-
- Load corner for CR 2000-3P1 steel, rustproof, incl. pressure piece, SAUTER CE P244021, € 720,-
- Pressure piece for CR 2000-3P1 steel, rustproof SAUTER CE P244022, € 125,-

Model	Nominal load	Price excl. of VAT ex works €
SAUTER		
CR 2500-1Q1	2,5 t/25 kN	285,-
CR 5000-1Q1	5 t/50 kN	285,-
CR 10000-1Q1	10 t/100 kN	285,-
CR 20000-1Q1	20 t/200 kN	560,-
CR 30000-1Q1	30 t/300 kN	560,-

** up to max. 25 t/250 kN

Model	Nominal load	Price excl. of VAT ex works €
SAUTER		
CR 60-3P1	60 kg/0,6 kN	930,-
CR 130-3P1	130 kg/1,3 kN	980,-
CR 250-3P1	250 kg/2,5 kN	890,-
CR 500-3P1	500 kg/5 kN	860,-
CR 1000-3P1	1000 kg/10 kN	860,-
CR 2000-3P1	2000 kg/20 kN	860,-

* up to max. 500 kg/5 kN

Tip

- Further details and technical data sheet as well as extensive accessories can be found online at www.kern-sohn.com



Fig. shows accessories, base plate **1** SAUTER CE Q30903 and bearings **2** SAUTER CE Q30904, for further accessories please visit our online shop



Fig. shows optional accessory load corner **3** SAUTER CE P4022

CB Q1 · CB Q2

Bending beam and shear beam load cells made from stainless steel



- Accuracy in accordance with OIML R60 C3
- CE and RoHS compliant
- Dust and spray protection to IP68/IP69K (in accordance with EN 60529), welded to create a hermetic seal
- Stainless steel
- Area of application: Weight measurement as well as compressive force in harsh environments
- Suitable for platform scales, weigh hoppers, floor scales and other weighing devices
- 4-wire connection
- Nominal sensitivity: 2 mV/V
- Note: Accuracy class OIML R60 C6 or EX version on request

CB P1

Load cells made from stainless steel



- Accuracy in accordance with OIML R60 C3
- CE and RoHS compliant
- Dust and spray protection to IP67 (in accordance with EN 60529), hermetically encapsulated
- Nickel-plated steel
- Area of application: Weight measurement as well as compressive force in harsh environments
- Suitable for platform scales, silo scales, bed scales and other diverse scales
- 4-wire connection
- Nominal sensitivity: 3 mV/V

Accessories CB Q1 · CB Q2:

- Traction device, steel, galvanised, suitable for CB Q1, SAUTER CE Q30901, **€ 85,-**
- Traction device, steel, rustproof, suitable for CB Q2, SAUTER CE Q34905, **€ 90,-**
- **1** Base plate, steel, galvanised, suitable for CB Q1, SAUTER CE Q30903, **€ 100,-**
- Base plate, steel, rustproof, suitable for CB Q1, SAUTER CE RQ30903, **€ 190,-**
- Base plate, steel, rustproof, suitable for CB Q2, SAUTER CE Q34903, **€ 95,-**
- **2** Bearing, steel, rustproof, suitable for CB Q1 (nominal load 5 kg–50 kg), SAUTER CE Q30904, **€ 120,-**
- Bearing, steel, rustproof, suitable for CB Q1 (nominal load 75 kg–300 kg), SAUTER CE Q30905, **€ 120,-**
- Bearing, steel, rustproof, suitable for CB 500-3Q1, SAUTER CE Q30906, **€ 205,-**
- Bearing, steel, rustproof, suitable for CB 750-3Q2, CB 1000-3Q2, CB 1500-3Q2, SAUTER CE Q34906, **€ 190,-**
- Load corner, steel, galvanised, suitable for CB Q1, SAUTER CE Q30907, **€ 220,-**
- Load corner, steel, rustproof, suitable for CB Q1, SAUTER CE RQ30907, **€ 315,-**
- Adjustable foot, steel, rustproof, suitable for SAUTER CE Q34901, **€ 70,-**

13

Model	Nominal load	Price
SAUTER	kg	excl. of VAT ex works €
CB 5-3Q1	5	230,-
CB 10-3Q1	10	230,-
CB 20-3Q1	20	230,-
CB 30-3Q1	30	230,-
CB 50-3Q1	50	230,-
CB 75-3Q1	75	230,-
CB 100-3Q1	100	230,-
CB 150-3Q1	150	230,-
CB 200-3Q1	200	230,-
CB 250-3Q1	250	230,-
CB 300-3Q1	300	230,-
CB 500-3Q1	500	230,-
CB 750-3Q2	750	240,-
CB 1000-3Q2	1000	240,-
CB 1500-3Q2	1500	240,-

* up to max. 500 kg

Model	Nominal load	Price
SAUTER	kg	excl. of VAT ex works €
CB 100-3P1	100	114,-
CB 250-3P1	250	114,-

Accessories CB P1:

- Adjustable foot, steel, nickel-plated, load base M12 for CT 500-3P1, CT 1000-3P1 and CT 1500-3P1, SAUTER CE P2012, **€ 27,-**
- **3** Load corner, steel, nickel-plated for CT 500-3P1, CT 1000-3P1 and CT 1500-3P1, SAUTER CE P4022, **€ 195,-**
- Spacer plates for bending beam CB P1 made from steel, SAUTER CE P3012, **€ 9,-**

Tip

- Further details and technical data sheet as well as extensive accessories can be found online at www.kern-sohn.com



Fig. shows optional accessory load corner 1 SAUTER CE RQ35903



Fig. shows optional accessory load corner 2 SAUTER CE P4022

CT Q1

Shear beam made from stainless steel



- Accuracy in accordance with OIML R60 C3
- CE and RoHS compliant
- Dust and spray protection to IP68/IP69K (in accordance with EN 60529), welded to create a hermetic seal
- Stainless steel
- Area of application: Weight measurement as well as compressive force in harsh environments
- Suitable for platform scales, weigh hoppers, flush-mounted floor scales and other weighing devices
- 6-wire connection
- Nominal sensitivity: 2 mV/V
- Note: EX version on request

Model	Nominal load kg	Price excl. of VAT ex works €
SAUTER		
CT 300-3Q1	300	220,-
CT 500-3Q1	500	220,-
CT 750-3Q1	750	220,-
CT 1000-3Q1	1000	220,-
CT 1500-3Q1	1500	220,-
CT 2000-3Q1	2000	220,-
CT 3000-3Q1	3000	435,-
CT 5000-3Q1	5000	435,-
CT 7500-3Q1	7500	570,-
CT 10000-3Q1	10000	570,-

* up to max. 500 kg

CT P1 · CT P2

Load cells made from stainless steel



- Accuracy in accordance with OIML R60 C3
- CE and RoHS compliant
- Dust and spray protection to IP67 (in accordance with EN 60529), welded to create a hermetic seal
- Nickel-plated steel
- Area of application: Weight measurement as well as compressive force in harsh environments
- Suitable for platform scales, weigh hoppers, flush-mounted floor scales and other weighing devices
- 4-wire connection
- Nominal sensitivity: 3 mV/V
- Note: EX version, 6-wire connection and accuracy class C4 or C5 on request
- **CT P2:** Delivery with calibrated characteristic value, if several cells are ordered, this means significantly less effort when aligning the corners of a platform

Model	Nominal load kg	Price excl. of VAT ex works €
SAUTER		
CT 500-3P1	500	98,-
CT 1000-3P1	1000	98,-
CT 1500-3P1	1500	98,-
CT 2500-3P1	2500	119,-
CT 3000-3P1	3000	119,-
CT 5000-3P1	5000	119,-
CT 10000-3P1	10000	173,-
CT 500-3P2	500	103,-
CT 1000-3P2	1000	103,-
CT 3000-3P2	3000	125,-
CT 5000-3P2	5000	124,-
CT 10000-3P2	10000	178,-

* up to max. 500 kg

Accessories CT Q1:

- Base plate, steel, rustproof, suitable for CT Q1, SAUTER CE RQ35911, € 200,-
- Base plate, steel, rustproof, suitable for CT 3000-3Q1, CT 5000-3Q1, SAUTER CE RQ35912, € 200,-
- Base plate, steel, rustproof, suitable for CT 7500-3Q1, CT 10000-3Q1, SAUTER CE RQ35919, € 860,-
- Bearing, steel, rustproof, suitable for CT Q1, SAUTER CE RQ35909, € 165,-
- Bearing, steel, rustproof, suitable for CT 3000-3Q1, CT 5000-3Q1, SAUTER CE RQ35910, € 320,-
- Bearing, steel, rustproof, suitable for CT 7500-3Q1, CT 10000-3Q1, SAUTER CE RQ35918, € 390,-
- Load corner, steel, rustproof, suitable for CT Q1, SAUTER CE RQ35902, € 420,-
- 1 Load corner, steel, rustproof, suitable for CT 3000-3Q1, CT 5000-3Q1, SAUTER CE RQ35903, € 620,-

Accessories CT P1:

- Load corner, steel, rustproof, suitable for CT 10000-3P1, CT 10000-3P2, SAUTER CE P40210, € 510,-
- 2 Load corner, steel, nickel-plated, suitable for CT 500-3P1, CT 1000-3P1, CT 1500-3P1, SAUTER CE P4022, € 195,-
- Load corner, steel, nickel-plated, suitable for CT 2500-3P1, CT 3000-3P1, CT 5000-3P1, SAUTER CE P4025, € 260,-
- Adjustable foot, steel, rustproof, suitable for CT 500-3P1, CT 1000-3P1, CT 1500-3P1, SAUTER CE P2012, € 27,-
- Adjustable foot, steel, rustproof, suitable for CT 2500-3P1, CT 3000-3P1, CT 5000-3P1, SAUTER CE P2018, € 38,-
- Adjustable foot, steel, rustproof, suitable for CT 10000-3P1, SAUTER CE P2024, € 113,-
- Spacer plate for CT 500-3P1, CT 500-3P2, CT 1000-3P1, CT 1000-3P2 and CT 1500-3P1, SAUTER CE P3012, € 9,-
- Spacer plate for CT 2500-3P1, CT 3000-3P1, CT 3000-3P2, CT 5000-3P1 and CT 5000-3P2 SAUTER CE P3015, € 9,-
- Spacer plate for CT 10000-3P1 and CT 10000-3P2 SAUTER CE P30110, € 27,-

Tip

- Further details and technical data sheet as well as extensive accessories can be found online at www.kern-sohn.com



CO Y1

Miniature button-type load cells made of stainless steel

STANDARD: IP 65, 1 DAY
 OPTION: DAKkS +3 DAYS, ISO +4 DAYS

- Accuracy in accordance with OIML G5
- High precision (comprehensive Error 0,05 % F.S.)
- RoHS compliant
- Dust and spray protection to IP65/IP67
- Scope of application: compressive force applications
- Suitable for Weight measurement as well as force and force test benches
- Nominal sensitivity: 1.0 – 1.5 mV/V

CO Y2

Miniature button-type load cells made of stainless steel

STANDARD: IP 65, 1 DAY
 OPTION: DAKkS +3 DAYS, ISO +4 DAYS

- Accuracy in accordance with OIML G5
- High precision (comprehensive Error 0,05 % F.S.)
- RoHS compliant
- Dust and spray protection to IP65
- Scope of application: for tensile and compressive force measurement
- Suitable for Weight measurement as well as force and force test benches
- Nominal sensitivity: 1,5 – 2 mV/V, depending on nominal load

CO Y5

Tension and compression load cells made of stainless steel

STANDARD: IP 66, M, 1 DAY
 OPTION: DAKkS +3 DAYS, ISO +4 DAYS
not CO 0.5-Y5

- Accuracy in accordance with OIML R60 G1
- CE and RoHS compliant
- Dust and spray protection to IP66 (in accordance with EN 60529)
- Stainless steel
- Very low profile
- Suitable for test stands, force measuring devices, Automation systems, etc.
- 4-wire connection
- Nominal sensitivity:
 CO 0.5-Y5, CO 1-Y5: 1 mV/V
 CO 5-Y5, CO 10-Y5: 2 mV/V

13

Model	Nominal load	Price excl. of VAT ex works €
SAUTER		
CO 10-Y1	10 kg/100 N	170,-
CO 20-Y1	20 kg/200 N	170,-
CO 50-Y1	50 kg/500 N	170,-
CO 100-Y1	100 kg/1 kN	170,-
CO 200-Y1	200 kg/2 kN	170,-
CO 500-Y1	500 kg/5 kN	200,-
CO 1000-Y1	1000 kg/10 kN	200,-
CO 2000-Y1	2000 kg/20 kN	235,-

** up to 500 kg/5 kN

Model	Nominal load	Price excl. of VAT ex works €
SAUTER		
CO 10-Y2	10 kg/100 N	250,-
CO 20-Y2	20 kg/200 N	250,-
CO 50-Y2	50 kg/500 N	250,-
CO 100-Y2	100 kg/1 kN	310,-
CO 200-Y2	200 kg/2 kN	310,-
CO 500-Y2	500 kg/5 kN	310,-
CO 1000-Y2	1000 kg/10 kN	310,-
CO 2000-Y2	2000 kg/20 kN	345,-

** up to 500 kg/5 kN

Model	Nominal load	Price excl. of VAT ex works €
SAUTER		
CO 0.5-Y5	0,5 kg/5 N	365,-
CO 1-Y5	1 kg/10 N	365,-
CO 5-Y5	5 kg/50 N	365,-
CO 10-Y5	10 kg/100 N	365,-

Tip

• Further details and technical data sheet as well as extensive accessories can be found online at www.kern-sohn.com



CJ P4



CJ P6



CJ P4PG



CJ X467



CJ X468

CJ P

Junctionbox CJ P for connecting several measuring cells to one evaluation unit

STANDARD

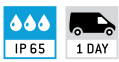

- Prepared for 4-wire and 6-wire load cells
- Models available for 2, 4, 6 or 8 load cells
- Robust aluminium die-cast housing
- Protection against dust and spray IP65

CJ X

Junctionbox for connecting several measuring cells to one evaluation unit

STANDARD



CJ X467 CJ X468

- Prepared for 4-wire and 6-wire load cells
- Models available for 4 load cells

CJ X467:

- Robust stainless steel housing with protection against dust and water splashes IP67

CJ X468:

- Robust aluminium die-cast housing with protection against dust and water splashes IP68

Model	Number of connections	Price excl. of VAT ex works €
SAUTER		
CJ P2	2	87,-
CJ P4	4	87,-
CJ P4PG	4	98,-
CJ P6	6	108,-
CJ P8	8	108,-

Model	Number of connections	Price excl. of VAT ex works €
SAUTER		
CJ X467	4	220,-
CJ X468	4	130,-

Tip

- Further details and technical data sheet as well as extensive accessories can be found online at www.kern-sohn.com



14

PALLET TRUCK SCALES



Weighing and transporting – just one operation

Speed up your warehouse and dispatch processes with the KERN pallet truck scales.

Get the exact weight of a load and at the same time, transport it to a specific location, all in one operation. This reduces commissioning times and avoids queues in front of fixed floor scales.

These mobile weighing solutions are space-saving and deliver reliable weighing results. Differences between given and actual weights can be determined quickly e.g. in the goods-in and out department. This uncovers inaccurate quantities, saves time and money and therefore ensures a very short amortisation period of the scales original cost.

KERN pallet truck scales are of robust industrial quality, with high-level protection against dust and water splashes, with high-contrast, easy-to-read displays as well as solid wheels and load rollers – all this helps to give you practical support in your work – day after day.

Of course, all KERN pallet truck scales can also be calibrated and delivered with a DAkkS calibration certificate (optional). This ensures the high level of accuracy of your pallet truck scale.

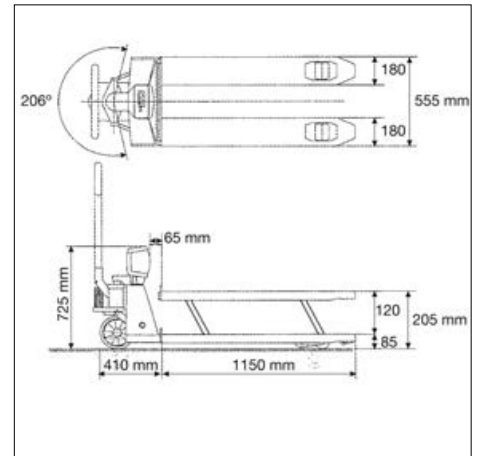

Pallet truck scale with complete protection against dust and water splashes IP65/67 and a memory for a container weight

Features

- PRE-TARE function for manual subtraction of a known container weight, useful for checking fill-levels
- **1** Display device: Plastic, protected against dust and water splashes IP65
- **2** Load fork: Protection against dust and water splashes IP67, temporary use in wet areas possible
- Pivot range 206°
- Castors: Solid rubber on aluminium rims
- **3** Load rollers: Tandem tyres to overcome thresholds and obstacles more easily
- Totalising of weights
- Ready for use: Batteries included, 4x1.5 V AA, operating time up to 80 h

Technical data

- Large LCD display, digit height 28 mm
- Permissible ambient temperature -10 °C/40 °C

Accessories

- **4** Castors made of polyurethane (colour exemplary) on aluminium rims. Ideal for light-coloured flooring as they leave less visible abrasive marks. Suitable for the current models of the pallet truck scale range KERN VHB (when retrofitting, please give the serial number of the pallet truck scale available when ordering), scope of delivery: 1 item, KERN VHB-A02, € 140,-

! Shipment via freight forwarder. Please ask for dimensions, gross weight, shipping

STANDARD

CAL EXT | SUM | UNIT | IP 65 | IP 67 | BATT | DMS | 2 DAYS

OPTION

DAkkS +3 DAYS

Model	Weighing capacity	Readability	Net weight	Price excl. of VAT ex works €	Option DAkkS Calibr. Certificate DAkkS KERN €
KERN VHB 2T1	[Max] kg 2000	[d] kg 1	approx. kg 110	1810,-	963-131 260,-

15

HANGING SCALES/ CRANE SCALES



TÜV-tested safety

KERN puts great emphasis on safety. For your safety, all KERN hanging and crane scales are subject to a stringent load test in accordance with EN 13155 and (Non-fixed load lifting attachments/breakage resistance) and EN 61010-1 (Electrical safety).

As well as the classic crane scales, we also have electronic tensile dynamometers which are extremely versatile thanks to their stable, compact construction. They can, for example, be fitted into testing machines, used for checking for overload, for bracing and tensile force measurement, etc.

This type of device is ideally suited for use between shackles or with a test bench. This is where the benefit of this construction comes to the fore, as the tensile force can be applied in both directions. These compact crane scales are also particularly suitable when weighing suspended loads where space is tight.

At the core of this construction is a robust load cell. Through the absence of moving parts, these scales are practical in maintenance and wear free.

Note

DAkkS calibration and conformity evaluation for crane scales up to 12 t



Do you use your crane scales in ISO-certified processes or where verification is mandatory? Then we can produce the right calibration certificate or the relevant Declaration of Conformity for your measuring device. Thanks to a modern crane scale test unit, we can calibrate or verify crane scales and force-measuring devices from any manufacturer to a maximum load of up to 12 t or 120 kN. You can find all the important details on pages 214, 219 or directly from one of our test service specialists, we will be pleased to help you.

Quick-Finder Hanging scales/Crane scales

Readability	Weighing capacity	Model	Price excl. of VAT ex works	Page								
[d] kg	[Max] kg	KERN	€		For an explanation on the pictos, see front flap							
0,005	5	HDB 5K5N	65,-	160	1							
0,005	6	HDB 6K-3XL	85,-	160	1							
0,01	10	HDB 10K10N	65,-	160	1							
0,01	15	HDB 10K-2XL	85,-	160	1							
0,01	20	HCB 20K10	120,-	161	1							
0,01	50	HGA 50K-2S05	108,-*	158	1							
0,02	15	CH 15K20	80,-	159	1							
0,02	30	HDB 30K-2XL	85,-	160	1							
0,02	50	HCB 50K20	131,-	161	1							
0,02	60	HCD 60K-2	210,-	163	1							
0,02 0,05	60 150	HCD 100K-2D	220,-	163	1							
0,05	50	CH 50K50	85,-	159	1							
0,05	99	HCB 99K50	114,-	161	1							
0,05	150	HCD 100K-2	210,-	163	1							
0,05 0,1	150 300	HCD 300K-2D	220,-	163	1							
0,05 0,1 0,2	150 300 600	HFD 600K-1	500,-	166	1							
0,05 0,1 0,2	150 300 600	HFD 600K-1IP	590,-	166	1							
0,1	50	CH 50K100	75,-	159	1							
0,1	50	HCB 50K100	104,-	161	1							
0,1	50	HCN 50K100IP	150,-	162	1							
0,1	200	HCB 200K100	131,-	161	1							
0,1	300	HCD 300K-1	210,-	163	1							
0,1	1000	HFM 1T0.1	1010,-	168	1							
0,1 0,2 0,5	300 600 1500	HFD 1T-4	510,-	166	1							
0,1 0,2 0,5	300 600 1500	HFD 1T-4IP	590,-	166	1							
0,2	100	HCB 100K200	114,-	161	1							
0,2	100	HCN 100K200IP	150,-	162	1							
0,2	600	HFA 600K-1	740,-	164	1							
0,2	600	HFC 600K-1	1180,-	165	1							
0,2	600	HFD 600K-1M	660,-	166	1							
0,2 0,5 1	600 1500 3000	HFD 3T-3	700,-	166	1							
0,2 0,5 1	600 1500 3000	HFD 3T-3IP	740,-	166	1							
0,5	200	HCB 200K500	109,-	161	1							
0,5	200	HCN 200K500IP	150,-	162	1							
0,5	1000	HFA 1T-4	750,-	164	1							
0,5	1000	HFC 1T-4	1180,-	165	1							
0,5	1500	HFD 1T-4M	650,-	166	1							
0,5	3000	HFM 3T0.5	1040,-	168	1							
0,5	5000	HFM 5T0.5	1400,-	168	1							
0,5 1 2	1500 3000 6000	HFD 6T-3	870,-	166	1							
0,5 1 2	1500 3000 6000	HFD 6T-3IP	920,-	166	1							
1	500	HCB 0.5T-3	215,-	161	1							
1	3000	HFA 3T-3	820,-	164	1							
1	3000	HFC 3T-3	1260,-	165	1							
1	3000	HFD 3T-3M	860,-	166	1							
1	10000	HFM 10T1	1860,-	168	2**							
1 2 5	3000 6000 12000	HFD 10T-3	1020,-	166	1							
1 2 5	3000 6000 12000	HFD 10T-3IP	1060,-	166	1							
2	1000	HCB 1T-3	280,-	161	1							
2	5000	HFA 5T-3	910,-	164	1							
2	5000	HFC 5T-3	1350,-	165	1							
2	6000	HFD 6T-3M	1050,-	166	1							
5	10000	HFA 10T-3	1420,-	164	1							
5	10000	HFC 10T-3	1860,-	165	1							
5	12000	HFD 10T-3M	1200,-	166	1							

* Price set of 5 units

** Shipment via freight forwarder. Please ask for dimensions, gross weight, shipping costs

● = standard ○ = option



Ultra compact, digital luggage scale for fast weighing of luggage and other suspended loads

Features

- This ergonomically-optimised luggage scale is perfectly suited for rapid, accurate checking of cases, bags, sports baggage, etc. The high maximum load means that there is sufficient safety reserve and can therefore also be used for weighing other, suspended loads
- Ergonomic design for easy handling
- Robust nylon fabric tape for secure fixing of the item to be weighed
- Simple and convenient 1-key operation
- Easy to toggle between units at the press of a button
- High mobility: thanks to battery operation, compact, lightweight construction, it is suitable for the use in several locations
- Automatic Hold function: When the weighing value remains unchanged the weight indicated on the display is automatically "frozen" for 10 sec. This leaves sufficient time to read the weight in peace

Technical data

- LCD display, digit height 9 mm
- Overall dimensions WxDxH 150x31x35 mm
- Ready for use: Batteries included, 3V CR2032, operating time up to 20 h, AUTO-OFF function to preserve the battery, Battery level indicator on display
- Net weight approx. 0,40 kg
- **Note:** The models are delivered in a set of 5 units. That means the prices given in the table refer to 5 units. Cannot be delivered individually. The calibration prices given here refer to calibration of a single balance

STANDARD				OPTION
UNIT	BATT	DMS	1 DAY	DAKkS +3 DAYS

Model	Weighing capacity [Max] kg	Readability [d] g	Quantity delivered (balances)	Price excl. of VAT ex works €	Option DAKkS Calibr. Certificate DAKkS KERN €	Quantity delivered (DAKkS Calibr. Certificate)
KERN HGA 50K-2S05	50	10	5	108,-*	963-128H 112,-	1

ONLY WHILE STOCKS LAST!

* Price set of 5 units



The classic among manual hanging scales – perfect for rapid weighing of higher loads

Features

- **1** With the TÜV certification mark, the scales meet the requirements of the standard EN 13155 (Non-fixed load lifting attachments/ Breakage resistance) and EN 61010-1 (Electrical safety)
- Ideal for rapid control in goods-in and goods-out
- Also essential in the private sector to determine the weight of fish, game, fruits, bicycle parts, suitcases etc.
- Hold function: For easy reading of the weighing result, the display can be „frozen“ in different ways. Either automatically when the weighing value remains unchanged or manually by pressing the Hold key
- Peak load display (peak hold)
- Hook made of Steel

Technical data

- LCD display, digit height 11 mm
- **2** Tape measure, extractable, length approx. 100 cm
- Ready for use: Batteries included, 9 V block, operating time up to 20 h
- Further weighing units: kg, lb, N
- Overall dimensions W×D×H
90×30×176,5 mm (without load hook)
90×30×270 mm (with load hook)
- Permissible ambient temperature 5 °C/35 °C

Accessories

- **3** Tare pan with pan beam, details see Accessories, KERN CH-A01N, € 93,-

STANDARD						OPTION

Model	Weighing capacity [Max] kg	Readability [d] g	Dimensions housing W×D×H mm	Net weight approx. kg	Price excl. of VAT ex works €	Option	
						DAkkS KERN	Calibr. Certificate €
CH 15K20	15	20	90×30×176,5	0,35	80,-	963-128H	112,-
CH 50K50	50	50	90×30×176,5	0,35	85,-	963-128H	112,-
CH 50K100	50	100	90×30×176,5	0,35	75,-	963-128H	112,-



Practical hanging scale for rapid, mobile weighing

Features

- **1** With the TÜV certification mark, the scales meet the requirements of the standard EN 13155 (Non-fixed load lifting attachments/ Breakage resistance) and EN 61010-1 (Electrical safety)
- HDB-XL: High-capacity XL-version. The larger design creates space for a large handle, which enables even better handling especially with heavier loads
- Ideal for rapid control in goods-in and goods-out
- Also essential in the private sector to determine the weight of fish, game, fruits, bicycle parts, suitcases etc.
- Hold function: For easy reading of the weighing result, the display can be „frozen“ in different ways. Either automatically when the weighing value remains unchanged or manually by pressing the Hold key
- Hook, steel, can be hinged
- Peak load display (peak hold)

Technical data

- LCD display, digit height 12 mm
- Ready for use: Batteries included, 2×1.5 V AAA, operating time up to 180 h
- Further weighing units: kg, lb, N
- Overall dimensions W×D×H (without load hook)
HDB-N: 72×25×105 mm
HDB-XL: 101×25×107 mm
- Overall dimensions W×D×H (with load hook)
HDB-N: 72×25×188 mm
HDB-XL: 101×25×203 mm
- Net weight approx. 0,20 kg
- Permissible ambient temperature 5 °C/35 °C

Accessories

- **2** Tare pan with pan beam, details see Accessories, KERN CH-A01N, € 93,-

15



Model	Weighing capacity [Max] kg	Readability [d] g	Dimensions housing W×D×H mm	Net weight approx. kg	Price excl. of VAT ex works €	Option	
						DAkKS KERN	Calibr. Certificate €
HDB 5K5N	5	5	72×25×105	0,20	65,-	963-127H	93,-
HDB 10K10N	10	10	72×25×105	0,20	65,-	963-128H	112,-
HDB 6K-3XL	6	5	107×25×101	0,20	85,-	963-128H	112,-
HDB 10K-2XL	15	10	107×25×101	0,20	85,-	963-128H	112,-
HDB 30K-2XL	30	20	107×25×101	0,20	85,-	963-128H	112,-



Handy hanging scale for higher loads

Features

- **1** With the TÜV certification mark, the scales meet the requirements of the standard EN 13155 (Non-fixed load lifting attachments/ Breakage resistance) and EN 61010-1 (Electrical safety)
- Ideal for rapid control in goods-in and goods-out
- Also essential in the private sector to determine the weight of fish, game, fruits, bicycle parts, suitcases etc.
- Hold function: For easy reading of the weighing result, the display can be „frozen“ in different ways. Either automatically when the weighing value remains unchanged or manually by pressing the Hold key
- Peak load display (peak hold), Measuring frequency 5 Hz
- [Max] ≤ 200 kg: Snap link (stainless steel) with safety catch as standard

- [Max] ≤ 200 kg: Hook (stainless steel) as standard
- **2** [Max] ≥ 500 kg: Reinforced version for heavy loads. Snap link and Hook not included

Technical data

- LCD display, digit height 12 mm
- Hole diameter of load support, model with [Max] ≤ 200 kg: approx. 14 mm [Max] ≥ 500 kg: approx. 16 mm Further weighing units: kg, lb, N
- Overall dimensions W×D×H ca. 82×43×153 mm (without load hook)
- Ready for use: Batteries included, 3×1.5 V AA, operating time up to 300 h
- Permissible ambient temperature 5 °C/35 °C

Accessories

- **3** Hook with safety catch, galvanised and lacquered cast steel, not rotatable, scope of delivery: 2 shackles, 1 connecting link, 1 hook, KERN YHA-06, **€ 130,-**
- **4** High-strength shackle, hot-dipped galvanised cast steel bracket, curved edge. Scope of delivery: 2 shackles, KERN YSC-04, **€ 65,-**

Suitable for model HCB 20K10

- **5** Tare pan with pan beam, details see Accessories, KERN CH-A01N, **€ 93,-**
- Accessories for models with [Max] ≤ 200 kg
- Snap link (stainless steel) with safety catch, opening approx. 15 mm, KERN HCB-A01, **€ 38,-**
- Hook (stainless steel), opening approx. 25 mm, KERN HCB-A02, **€ 24,-**

STANDARD						OPTION
CAL EXT	UNIT	MOVE	BATT	DMS	1 DAY	DAKkS +3 DAYS

Model	Weighing capacity [Max] kg	Readability [d] g	Net weight approx. kg	Price excl. of VAT ex works €	Option	
					DAKkS KERN	Calibr. Certificate €
KERN HCB 20K10	20	10	0,30	120,-	963-128H	112,-
KERN HCB 50K20	50	20	0,30	131,-	963-128H	112,-
KERN HCB 50K100	50	100	0,30	104,-	963-128H	112,-
KERN HCB 99K50	99	50	0,30	114,-	963-129H	131,-
KERN HCB 100K200	100	200	0,30	114,-	963-129H	131,-
KERN HCB 200K100	200	100	0,30	131,-	963-129H	131,-
KERN HCB 200K500	200	500	0,30	109,-	963-129H	131,-
KERN HCB 0.5T-3	500	1000	0,40	215,-	963-130H	235,-
KERN HCB 1T-3	1000	2000	0,60	280,-	963-130H	235,-



Robust, compact hanging scale with high level of protection against dust and water spray

Features

- **1** With the TÜV certification mark, the scale meets the requirements of the standard EN 13155 (Non-fixed load lifting attachments/ Breakage resistance) and EN 61010-1 (Electrical safety)
- Housing Stainless steel, IP65-protected against dust and water splashes
- Ideal for rapid control in goods-in and goods-out
- Also essential in the private sector to determine the weight of fish, game, fruits, bicycle parts, suitcases etc.
- Hold function: For easy reading of the weighing result, the display can be „frozen“ in different ways. Either automatically when the weighing value remains unchanged or manually by pressing the Hold key
- Peak load display (peak hold)
- Internal measuring frequency: 5 Hz
- Snap link (stainless steel) with safety catch as standard
- Hook (stainless steel) as standard

Technical data

- LCD display, digit height 12 mm
- Hole diameter of load support ca. 14 mm
- **2** Second display on the back of the balance
- Ready for use: Batteries included, 2×1.5 V AA, operating time up to 200 h

Accessories

- Snap link (stainless steel) with safety catch, opening approx. 15 mm, KERN HCB-A01, **€ 38,-**
- Hook (stainless steel), opening approx. 25 mm, KERN HCB-A02, **€ 24,-**

15

STANDARD							OPTION	
CAL EXT	UNIT	MOVE	IP 65	BATT	DMS	1 DAY	DAkkS	+3 DAYS

Model	Weighing capacity [Max] kg	Readability [d] g	Dimensions housing W×D×H mm	Net weight approx. kg	Price excl. of VAT ex works €	Option DAkkS Calibr. Certificate	
						DAkkS KERN	€
KERN HCN 50K100IP	50	100	96×48×179	0,85	150,-	963-128H	112,-
KERN HCN 100K200IP	100	200	96×48×179	0,50	150,-	963-129H	131,-
KERN HCN 200K500IP	200	500	96×48×179	0,50	150,-	963-129H	131,-

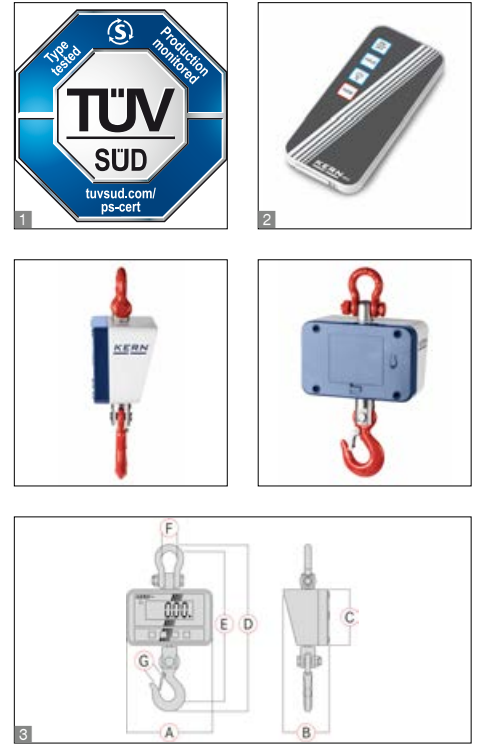

High-resolution crane scale for loads up to 300 kg

Features

- Fully-equipped crane scale for low to medium load ranges. The solid design guarantees that extra level of safety (TÜV tested). Thanks to the large LCD display and the remote control which is delivered as standard, it can also be operated safely from a distance and results can be read off
- With the TÜV certification mark, the scales meet the requirements of the standard EN 13155 (Non-fixed load lifting attachments/ Breakage resistance) and EN 61010-1 (Electrical safety)
- High level of mobility: thanks to battery pack operation, compact construction and low weight, it is suitable for use in several locations (production, warehouse, dispatch department, etc.)
- Hold function: For easy reading of the weighing result, the display can be „frozen“ in different ways. Either automatically when

the weighing value remains unchanged or manually by pressing the Hold key

- Tare: Resets the display to „0“ when there is a load on the scale. Now removed or added loads are directly displayed
- Battery level indicator, LED visual display
- Large high-contrasted display that is easy to read
- Standby function: display automatically switched off after 5 min without a change of load. Automatic activation with the touch of a key
- Hook with safety catch, revolving
- Shackle and safety catch made of nickel-plated steel
- Infrared remote control standard. Range up to 20 m. All functions can be selected. W×D×H 65×24×100 mm. Batteries included

Technical data

- Backlit LCD display, digit height 28 mm
- Ready for use: Batteries standard, 4×1.5 V AA, operating time approx. 100 h
- Precision: 0,2 % of [Max]
- Permissible ambient temperature 5 °C/40 °C

Accessories

- Internal rechargeable battery pack for load receptor, operating time up to 50 h without backlight, charging time approx. 12 h. Weighing is not possible during the charging process, KERN HCD-A01, € 54,-



Model	Weighing capacity [Max] kg	Readability [d] g	Net weight approx. kg	③ Dimensions							Price excl. of VAT ex works €	Option DAKKS Calibr. Certificate	
				A mm	B mm	C mm	D mm	E mm	F mm	G mm		DAKKS KERN	€
KERN HCD 60K-2	60	20	1,2	150	79,3	97,7	276,5	246,5	26	23,5	210,-	963-129H	131,-
KERN HCD 100K-2	150	50	1,2	150	79,3	97,7	276,5	246,5	26	23,5	210,-	963-129H	131,-
KERN HCD 300K-1	300	100	1,2	150	79,3	97,7	276,5	246,5	26	23,5	210,-	963-129H	131,-
Multi-range balance, with increasing load it switches automatically to the next largest weighing range [Max] and readout [d] and when the load is fully removed, the balance switches back to the lower range													
KERN HCD 100K-2D	60 150	20 50	1,2	150	79,3	97,7	276,5	246,5	26	23,5	220,-	963-129H	131,-
KERN HCD 300K-2D	150 300	50 100	1,2	150	79,3	97,7	276,5	246,5	26	23,5	220,-	963-129H	131,-

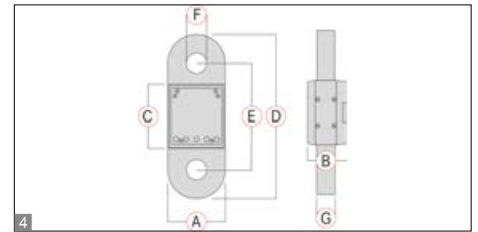

Compact crane scale with integrated display can also be used for tensile force measurement

Features

- **1** With the TÜV certification mark, the scales meet the requirements of the standard EN 13155 (Non-fixed load lifting attachments/ Breakage resistance) and EN 61010-1 (Electrical safety)
- With its high-quality finish, low weight and compact dimensions, this crane scale (tensile force gauge) is an essential device for industrial use, on building sites, in freight centres, ports etc.
- Because of its compact design it is also ideally suited for installation in systems where space is limited, etc.
- Ideally suited for determining weight quickly while loading and unloading
- Peak load display (peak hold)
- Hold function: For easy reading of the weighing result, the display can be „frozen“ in different ways. Either automatically when the weighing value remains unchanged or manually by pressing the Hold key
- Tare: Resets the display to „0“ when there is a load on the scale. Now removed or added loads are directly displayed

Technical data

- Large backlit LCD display, digit height 23 mm
- Material and design of housing/load support, models with [Max] ≤ 3 t: Aluminium/Stainless steel bushing [Max] > 3 t: Steel/Steel
- Rechargeable battery pack integrated, as standard, operating time up to 30 h without backlight, charging time approx. 12 h
- Optional battery operation, 3×1.5 V AA not included in scope of delivery, operating time up to 40 h
- Precision: 0,2% of [Max]
- Internal measuring frequency: 60 Hz
- Further weighing units: kg, lb, N
- Permissible ambient temperature 5 °C/35 °C

Accessories

- **2** High-strength shackle, hot-dipped galvanised cast steel bracket, bow shaped. Scope of delivery: 2 shackles with lacquered screw bolts, suitable for models with [Max] ≤ 5 t: KERN YSC-01, € 100,- [Max] > 5 t: KERN YSC-02, € 230,-
- **3** Hook with safety catch, cast steel, galvanised and lacquered, non-revolving. Scope of delivery: 2 shackles, 1 lacquered screw bolt, 1 hook, suitable for models with [Max] ≤ 1 t: KERN YHA-01, € 185,- [Max] = 3 t: KERN YHA-02, € 210,- [Max] = 5 t: KERN YHA-03, € 250,- [Max] > 5 t: KERN YHA-04, € 450,-

15

STANDARD

CAL EXT UNIT BATT ACCU MULTI DMS 1 DAY

OPTION

DAkkS +3 DAYS

Model	Weighing capacity [Max] kg	Readability [d] g	Net weight approx. kg	Dimensions							Price excl. of VAT ex works €	Option DAkkS Calibr. Certificate	
				A mm	B mm	C mm	D mm	E mm	F mm	G mm		DAkkS KERN	€
KERN HFA 600K-1	600	200	1,8	90	62	100	255	165	32	30	740,-	963-130H	235,-
KERN HFA 1T-4	1000	500	1,8	90	62	100	255	165	32	30	750,-	963-130H	235,-
KERN HFA 3T-3	3000	1000	2,0	90	62	100	255	165	32	30	820,-	963-132H	590,-
KERN HFA 5T-3	5000	2000	4,0	90	62	100	255	165	30	30	910,-	963-132H	590,-
KERN HFA 10T-3	10000	5000	6	90	72	100	275	185	40	40	1420,-	963-133H	830,-

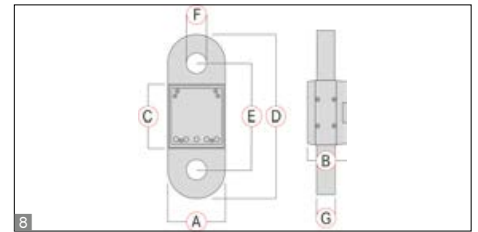

Compact crane scale for use in harsh environmental conditions or where space is limited, with convenient hand-held terminal

Features

- **1** With the TÜV certification mark, the scales meet the requirements of the standard EN 13155 (Non-fixed load lifting attachments/ Breakage resistance) and EN 61010-1 (Electrical safety)
- With its high-quality finish, low weight and compact dimensions, this crane scale (tensile force gauge) is an essential device for industrial use, on building sites, in freight centres, ports etc.
- Because of its compact design it is also ideally suited for installation in systems where space is limited, etc.
- Peak load display (peak hold)
- Hold function: When the weighing value remains unchanged the weight indicated on the display is automatically “frozen” until the Hold key is pressed
- Tare: Resets the display to „0“ when there is a load on the scale. Now removed or added loads are directly displayed

- **2** Display device with integrated radio module, which the user can carry around with him, thanks to the convenient hand strap **3**, standard. In this way the weighing data can always be read off the display device by the user, even when the user is a long way from the load receptor (force gauge) or under poor lighting conditions. Range up to 20 m. All functions can be selected (Can be ordered separately)

Technical data

- Material and design of housing/load support, models with
[Max] ≤ 3 t: Aluminium/Stainless steel bushing
[Max] > 3 t: Steel/Steel
- Precision: 0,2% of [Max]
- Internal measuring frequency: 10 Hz
- Further weighing units: kg, lb, N
- Permissible ambient temperature 5 °C/35 °C

Display device

- Large backlit LCD display, digit height 23 mm
- Rechargeable battery pack integrated, as standard, operating time up to 30 h without backlight, charging time approx. 12 h

- Dimensions of display device W×D×H 88×64×256 mm
- Net weight 0,5 kg

Load receptor

- **4** Optional battery operation, 3×1.5 V AA not included in scope of delivery, operating time up to 40 h

Accessories

- **5** Load receptor: Rechargeable battery pack internal, operating time up to 30 h, without backlight, charging time approx. 12 h, KERN HFA-A01, **€ 44,-**
- Display device: Rechargeable battery pack internal, KERN HFC-A01, **€ 70,-**
- **6** High-strength shackle, hot-dipped galvanised cast steel bracket, bow shaped. Scope of delivery: 2 shackles with lacquered screw bolts, suitable for models with [Max] ≤ 5t: KERN YSC-01, **€ 100,-** [Max] > 5t: KERN YSC-02, **€ 230,-**
- **7** Hook with safety catch, cast steel, galvanised and lacquered, non-revolving. Scope of delivery: 2 shackles, 1 lacquered screw bolt, 1 hook, suitable for models with [Max] ≤ 1t: KERN YHA-01, **€ 185,-** [Max] = 3t: KERN YHA-02, **€ 210,-** [Max] = 5t: KERN YHA-03, **€ 250,-** [Max] > 5t: KERN YHA-04, **€ 450,-**

STANDARD

CAL EXT UNIT BATT ACCU MULTI DMS 1 DAY

OPTION

ACCU DAKKS +3 DAYS

Model	Weighing capacity [Max] kg	Readability [d] g	Net weight approx. kg	B Dimensions								Price excl. of VAT ex works €	Option DAKKS Calibr. Certificate	
				A mm	B mm	C mm	D mm	E mm	F mm	G mm	DAKKS KERN		€	
KERN HFC 600K-1	600	200	1,8	90	62	100	255	165	32	27	1180,-	963-130H	235,-	
KERN HFC 1T-4	1000	500	1,8	90	62	100	255	165	32	32	1180,-	963-130H	235,-	
KERN HFC 3T-3	3000	1000	2,2	90	62	100	255	165	32	32	1260,-	963-132H	590,-	
KERN HFC 5T-3	5000	2000	4,0	90	62	100	255	165	30	30	1350,-	963-132H	590,-	
KERN HFC 10T-3	10000	5000	6	90	72	100	275	185	40	40	1860,-	963-133H	830,-	



KERN HFD-M



KERN HFD/HFD-IP

Robust, high-resolution crane scale up to 12 t, also with EC type approval [M] or protection type IP67



High mobility: thanks to rechargeable battery operation, compact, lightweight construction, it is suitable for the use in several locations (production, warehouse, dispatch department etc.)

Solid shackles, non-revolving

Radio remote control standard. Range up to 20 m. All functions can be selected. W×D×H 65×24×100 mm. Batteries included, 1× 12 V 23A

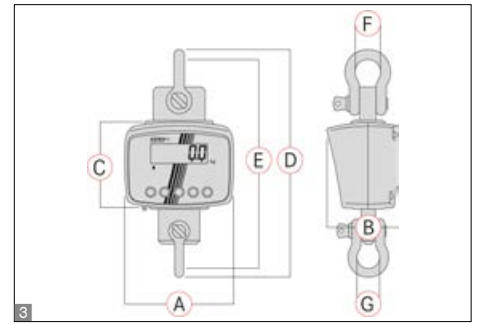

Features

- **1** With the TÜV certification mark, the scales meet the requirements of the standard EN 13155 (Non-fixed load lifting attachments/ Breakage resistance) and EN 61010-1 (Electrical safety)
- Because of its stable construction and robust design, it is ideal for continuous use in industrial environment
- Hold function: the weight display is „frozen“ when the Hold button is pressed (Not usable with HFD-M)
- Tare: Resets the display to „0“ when there is a load on the scale. Now removed or added loads are directly displayed

KERN HFD-IP

- The models with IP add-on have special spray and dust protection to IP67 and because of this they are ideal for use in harsh environments

KERN HFD-M

- The models with M add-on have EC type approval and because of this they are ideal for use in verified applications such as, for example, calculation of a total price, based on weight
- Will support you when weighing freight in a SOLAS compliant manner
- Sleep function: when the sleep button is pressed, the weight display is switched off, but the value remains stored. This can extend the battery life

Technical data

- Superior display size: digit height 30 mm, bright backlight for easy reading of weighing results, even in poor lighting conditions
- Rechargeable battery pack integrated, as standard, operating time up to 70 h without backlight, charging time approx. 12 h, Battery pack accessible from the outside, which means it is easy to replace
- Precision: 0,2% of [Max]
- Permissible ambient temperature -10 °C/40 °C

Accessories

- Internal rechargeable battery pack for load receptor, operating time up to 70 h without backlight, charging time approx. 12 h, Internal rechargeable battery pack, operating time up to 70 h without backlight, charging time approx. 12 h, KERN HFD-A04, **€ 98,-**
- Charging station for external battery charging, scope of delivery: charging station, exchangeable battery, mains adapter, KERN HFD-A07, **€ 120,-**
- **2** Hook with safety catch, cast steel, galvanised and lacquered, non-revolving, suitable for models
HFD 600, HFD 1T: KERN HFD-A01, **€ 50,-**
HFD 3T: KERN HFD-A02, **€ 73,-**
HFD 6T, HFD 10T: KERN HFD-A03, **€ 130,-**
- Bluetooth data interface for wireless data transfer to PC or tablets, must be ordered at purchase, KERN HFD-A06, **€ 255,-**

STANDARD

CAL EXT | IP 67 | ACCU | MULTI | DMS | 1 DAY

HFD-IP

OPTION

DAKkS +3 DAYS | BT 4.0 | M +3 DAYS

HFD-M

Model	Weighing capacity [Max] kg	Readability [d] g	Net weight approx. kg	3 Dimensions						Price excl. of VAT ex works €	Verification M III KERN €	Option		
				A	B	C	D	E	F = G			DAKkS KERN	Calibr. Certificate DAKkS KERN	
Multi-range balance, with increasing load it switches automatically to the next largest weighing range [Max] and readout [d] and when the load is fully removed, the balance switches back to the lower range														
HFD 600K-1	150 300 600	50 100 200	9	194	129	160	422	384	50,8	500,-	-	-	963-130H	235,-
HFD 1T-4	300 600 1500	100 200 500	9	194	129	160	422	384	50,8	510,-	-	-	963-130H	235,-
HFD 3T-3	600 1500 3000	200 500 1000	10	194	129	160	457	413	58	700,-	-	-	963-132H	590,-
HFD 6T-3	1500 3000 6000	500 1000 2000	15	194	129	160	518	467	68,3	870,-	-	-	963-132H	590,-
HFD 10T-3	3000 6000 12000	1000 2000 5000	20	194	129	160	584	521	82,5	1020,-	-	-	963-133H	830,-
Protection against dust and water splashes IP67														
HFD 600K-1IP	150 300 600	50 100 200	9	194	129	160	422	384	50,8	590,-	-	-	963-130H	235,-
HFD 1T-4IP	300 600 1500	100 200 500	9	194	129	160	422	384	50,8	590,-	-	-	963-130H	235,-
HFD 3T-3IP	600 1500 3000	200 500 1000	10	194	129	160	457	413	58	740,-	-	-	963-132H	590,-
HFD 6T-3IP	1500 3000 6000	500 1000 2000	15	194	129	160	518	467	68,3	920,-	-	-	963-132H	590,-
HFD 10T-3IP	3000 6000 12000	1000 2000 5000	20	194	129	160	584	521	82,5	1060,-	-	-	963-133H	830,-

Note: For applications that require verification, please order verification at the same time, initial verification at a later date is not possible.

Verification at the factory, we need to know the full address of the location of use.

HFD 600K-1M	600	200	9	194	129	160	422	384	50,8	660,-	965-130H	143,-	963-130H	235,-
HFD 1T-4M	1500	500	9	194	129	160	422	384	50,8	650,-	965-130H	143,-	963-130H	235,-
HFD 3T-3M	3000	1000	10	194	129	160	457	413	58	860,-	965-132H	225,-	963-132H	590,-
HFD 6T-3M	6000	2000	15	194	129	160	518	467	68,3	1050,-	965-132H	225,-	963-132H	590,-
HFD 10T-3M	12000	5000	20	194	129	160	584	521	82,5	1200,-	965-133H	340,-	963-133H	830,-

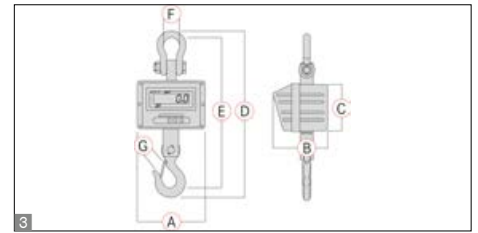

Robust industrial crane scale with bright LED display for optimum reading in unfavourable ambient conditions

Features

- **1** With the TÜV certification mark, the scales meet the requirements of the standard EN 13155 (Non-fixed load lifting attachments/ Breakage resistance) and EN 61010-1 (Electrical safety)
- Professional device for robust applications in production, quality control, logistics etc. Because of its stable construction and robust design, it is ideal for continuous use in industrial environment
- High mobility: thanks to rechargeable battery operation, compact, lightweight construction, it is suitable for the use in several locations (production, warehouse, dispatch department etc.)

- Adaptation to unstable environmental conditions by changing the readability
- Hold function: the weight display is „frozen“ when the Hold button is pressed
- Tare: Resets the display to „0“ when there is a load on the scale. Now removed or added loads are directly displayed
- Hook with safety catch, revolving
- **2** Radio remote control standard. Range up to 20 m. All functions can be selected (excl. ON/OFF). W×D×H 48×10×95 mm. Batteries included, 2×1.5 V AAA

Technical data

- Superior display size: digit height 30 mm, bright backlight for easy reading of weighing results, even in poor lighting conditions
- Rechargeable battery pack integrated, as standard, operating time up to 50 h without backlight, charging time approx. 14 h
- Precision: 0,2 % of [Max]
- Permissible ambient temperature 0 °C/40 °C

STANDARD OPTION

CAL EXT
 ACCU
 MULTI
 DMS
 1 DAY
 2 DAYS
 3 DAYS

Model	Weighing capacity [Max] kg	Readability [d] g	Net weight approx. kg	3 Dimensions							Price excl. of VAT ex works €	DAkkS Calibr. Certificate DAKKS KERN	Certificate €
				A mm	B mm	C mm	D mm	E mm	F mm	G mm			
HFM 1T0.1	1000	100	14	270	200	175	610	540	68	40	1010,-	963-130H	235,-
HFM 3T0.5	3000	500	16	270	200	175	610	540	74	40	1040,-	963-132H	590,-
HFM 5T0.5	5000	500	24	300	230	190	730	650	74	55	1400,-	963-132H	590,-
HFM 10T1	10000	1000	34	300	230	190	840	750	92	60	1860,-	963-133H	830,-

16 ACCESSORIES



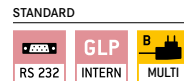
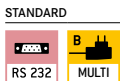
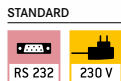

Important note for printer orders:

Please state your balance model when ordering, so that the printer can be preconfigured in the factory to suit your balance.

**Matrix needle printer
KERN 911-013**

For printing weighing results on normal paper, which is ideal for long-term archiving.

**Matrix needle printer
KERN YKN-01**

For printing weighing results on normal paper, which is ideal for long-term archiving.

**Thermal printer
KERN YKB-01N**

For printing weighing results, recipes, quantities etc. or for GLP record keeping of balance adjustment with date and time print. GLP/GMP compliant print form available as standard. Language versions: DE, EN, FR.

Technical data

- Needle print
- Speed: 1,8 line/s
- Max. 40 characters per line
- Width of the paper strip: 57 mm wide
- Operation via mains adapter 230 V/50 Hz (standard EU), as standard
- Dimensions housing: W×D×H 100×180×106 mm
- Not suitable for KERN PNS/PNJ, PES/PEJ ranges
- Interface cable not included with delivery, see page 173

Price printer without interface cable, KERN 911-013, **€ 480,-**

Technical data

- Needle print
- Speed: 1 line/s
- Max. 16 characters per line
- Width of the paper strip: 44 mm wide
- Operation via mains adapter 230 V/50 Hz (standard EU/GB/USA), as standard
- Dimensions housing: W×D×H 158×106×40 mm
- Interface cable not included with delivery, see page 173

Price printer without interface cable, KERN YKN-01, **€ 310,-**

Technical data

- Thermal print
- Speed: 0,75 lines/s
- Max. 40 characters per line
- Width of the paper strip: 112 mm wide
- Operation via mains adapter 230 V/50 Hz (standard EU/GB/USA), as standard
- Dimensions housing: W×D×H 165×140×50 mm
- Interface cable not included with delivery, see page 173

Price printer without interface cable, KERN YKB-01N, **€ 355,-**

Accessories

- Paper rolls (10 pcs.), KERN 911-013-010, **€ 40,-**
- Universal mains adapter, standard EU/GB/US, KERN ABS-A01, **€ 86,-**

Accessories

- Paper rolls (5 pcs.), KERN YKN-A01, **€ 38,-**

Accessories

- Paper rolls (10 pcs.), KERN YKB-A10, **€ 59,-**

Individual header data:

For printers **KERN 911-013, YKN-01, YKB-01N and YKE-01** (in combination with **YKI-02**) the free software **KERN SHM-01** (see www.kern-sohn.com) can be used to print 4 header lines on the printout (see marking on balance). Compatible models: KERN 440, DE, FCB, FKB-A, PCB, PCD.



STANDARD



STANDARD



Tipp

EasyTouch Individual Print

The print product (e.g. labels) can be individually designed. The size of the print area as well as the placement of the print elements can be customized. The barcode function enables the printing of each element as a barcode.

For further details, see also page 132ff *EasyTouch*

Important note for printer orders:

Please state your balance model when ordering, so that the printer can be preconfigured in the factory to suit your balance.

Thermal statistics printer KERN YKS-01

For printing weighing results, recipes etc. or for GLP record keeping of weighing data with date and time print. Numerator; with statistical functions such as count and total of all measurements, minimum and maximum values of the main unit, range, average value, standard deviation, available units: mg, g, kg, pcs. Language versions: DE, EN, FR.

Technical data

- Thermal print
- Speed: 0,75 lines/s
- Max. 40 characters per line
- Width of the paper strip: 112 mm wide
- Operation via mains adapter 230 V/50 Hz (standard EU/GB/USA), as standard
- Dimensions housing: W×D×H 165×140×50 mm
- Interface cable not included with delivery, see page 173
- Note: Please order the matching paper roll with it, see accessories
- Not suitable for KERN EWJ, PFB-M ranges as well as KERN moisture analysers and counting scales

Price printer without interface cable, KERN YKS-01, **€ 460,-**

Accessories

- Paper rolls (10 pcs.), KERN YKB-A10, **€ 59,-**

Thermal label printer KERN YKE-01

Affordable universal label printer to print out weighing results on thermal labels. ASCII-capable. Comfortable Auto-Forward function for automatic jump from label to label (only with KERN standard labels).

Technical data

- Thermal print
- Speed: 22 mm/s
- Max. 82 characters per line
- Width of the paper strip: YKE-A02: 78 mm YKE-A03: 112 mm
- Operation via mains adapter 230 V/50 Hz (standard EU/GB/USA), as standard
- Dimensions housing: W×D×H 150×155×65 mm
- Interface cable not included with delivery, see page 173
- Note: Please order the matching label roll with it, see accessories
- Not suitable for KERN BFS, CCS, CFS, DAB, DBS, DLB, IFS, KFS-TM, RPB ranges, counting scales

Price printer without interface cable, KERN YKE-01, **€ 790,-**

Accessories

- Paper roll (1 pc.), Dimensions labels: W×D 73×61 mm, 100 labels, KERN YKE-A02, **€ 32,-** W×D 105×48 mm, 45 labels, KERN YKE-A03, **€ 32,-**

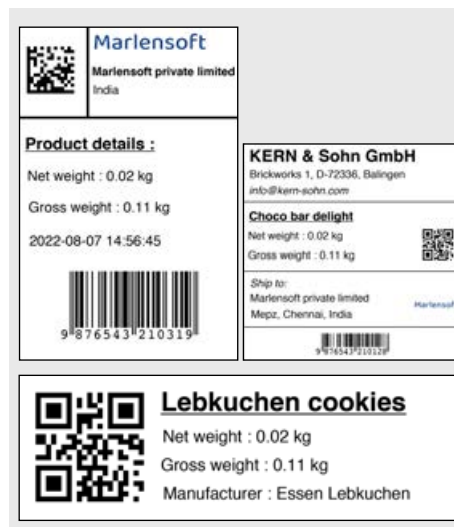

Example printouts with ET Individual Print

Individual header data:

For printers **KERN 911-013, YKN-01, YKB-01N and YKE-01** (in combination with **YKI-02**) the free software **KERN SHM-01** (see www.kern-sohn.com) can be used to print 4 header lines on the printout (see marking on balance). Compatible models: KERN 440, DE, FCB, FKB-A, PCB, PCD.

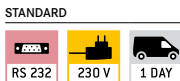
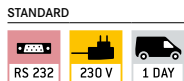

Important note for printer orders:

Please state your balance model when ordering, so that the printer can be preconfigured in the factory to suit your balance.

**Dot matrix printer
KERN YKG-01**

High-quality dot matrix printer

Flexible and rapid dot matrix printer for retail, the catering trade and for restaurant kitchens. To print the weights on normal paper, which is ideal for long-term archiving. This model has an interchangeable interface and you will be impressed by how easy it is to replace the paper and ribbon

Technical data

- Needle print
- Speed: 4,7 line/s
- Max. 42 characters per line
- Supported paper widths: 58 mm, 70 mm, 76 mm (roll)
- Operation via mains adapter 230 V/50 Hz standard EU, as standard
- Interfaces: RS-232, cash drawer connection, bidirectional parallel
- Interface cable not included with delivery, see page 166
- Dimensions housing B×T×H 160×248×139 mm
- Not suitable for KERN DAB, DBS, DLB, FKT, RFE ranges

Price printer without interface cable, KERN YKG-01, **€ 590,-**

Accessories

- Paper rolls (5 pcs.), KERN YKG-A01, **€ 30,-**

**Thermal printer
KERN YKH-01**

High-quality thermal printer – fast, robust, user-friendly

Robust, low-maintenance dot matrix printer for retail, the catering trade and for restaurant kitchens. Extremely compact and long-lasting. Thanks to the waterproof switch cover it is particularly suitable for use under tough, loud environmental conditions

Technical data

- Thermal print
- Speed: 2 line/s
- Max 64 characters per line
- Supported paper widths: 58 mm, 80 mm (roll)
- Operation via mains adapter 230 V/50 Hz standard EU, as standard
- Interfaces: RS-232
- Interface cable not included with delivery, see page 166
- Dimensions housing B×T×H 140×199×146 mm
- Not suitable for KERN DAB, DBS, DLB, FKT, RFE ranges

Price printer without interface cable, KERN YKH-01, **€ 420,-**

Accessories

- Paper rolls (5 pcs.), KERN YKH-A01, **€ 30,-**

Individual header data:

For printers **KERN 911-013, YKN-01, YKB-01N and YKE-01** (in combination with **YKI-02**) the free software **KERN SHM-01** (see www.kern-sohn.com) can be used to print 4 header lines on the printout (see marking on balance). Compatible models: KERN 440, DE, FCB, FKB-A, PCB, PCD.

Interface cable for RS-232

For direct connection to a printer or PC, cable length approx. 1.5 m.
The interface parameters can be set using the balance keypad.

Tip

The interface cable is **free of charge** if you purchase balance, printer or Ethernet-/WiFi-/Bluetooth adapter together.

Printer, ...	PC, YKI-01/ -02/-03 KERN	911-013, YKB-01N, YKN-01 KERN	YKE-01 KERN	YKG-01, YKH-01 KERN	YKS-01 KERN	Price cable excl. of VAT ex works €
440, 572, 573, ALJ, ALS, ALT-B, CDS, CKE, DE-D, DS, EMB-V, FCB, FKA, FKB, FKC, FKB-A, IKT, KB, PCB, PCD, PLJ, PLS, KDP				572-926		50,-
BKN, BXS, IXS, KXS-TM, SXS				KXS-A04 (Factory Option)		109,-
EOC, IOC, BID, KIB-T, KIB-TM				EOC-A12		66,-
YKV-01, KGP	572-926			-		50,-
ABJ-NM, ABS-N				ACS-A01		115,-
BFA, BFB, BFN (until year of construction 2019), GAB-N, GAB-P, IFB, KFB-TM, KFN-TM, NFB, NFN (until year of construction 2019) PFB, SFB, UFA, UFB, UFC, UFN				CFS-A01		
BFS, CPB, EWJ, KFS-TM, PFB, PFB-M				CFS-A01		-
CFS, CCS, KFS-TM, IFS (from year of production 2015)	-	CFS-A01	-	-	-	
ABT-NM, PBJ, PBS				770-926		
DBS, DLB	572-926			-	-	
DAB	MLB-A05		MLB-A05	-	MLB-A05	50,-
ABP, FES/FEJ, KFS-T				MLB-A05		-
ADB, ADJ, ACS, ACJ, PNS/PNJ				MLB-A05		
HFT				KFF-A01		
EG-N, EW-N				474-926		
PES/PEJ (Interface cable for printer YKB-01: MLB-A05)				CCA-A01		
CCA				CCA-A01		
RFE, RPB (not compatible with YKN-01)	-	CFS-A01	-	CFS-A01	-	

With products from KERN you are ready to face the challenges of Industry 4.0

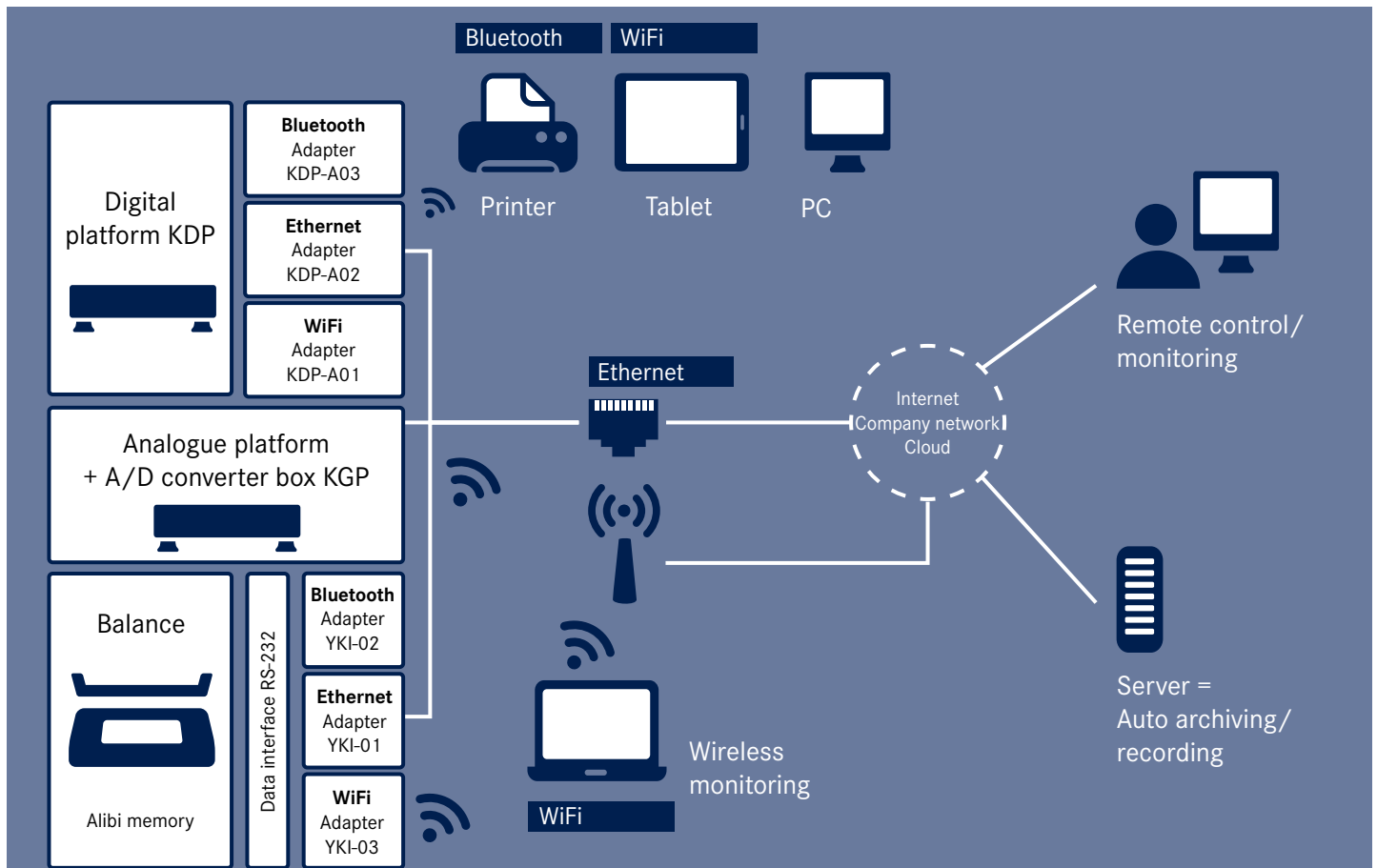

We will help to combine industrial production with the latest information and communication technology, with the aim of improving quality, reducing costs and using time and resources more efficiently so that you are able to react to future requirements in a more flexible manner. You will benefit from our uniform data protocol combined with our BalanceConnection 4.0 data software, for details please see page 167/168.

KERN Software BalanceConnection SCD-4.0

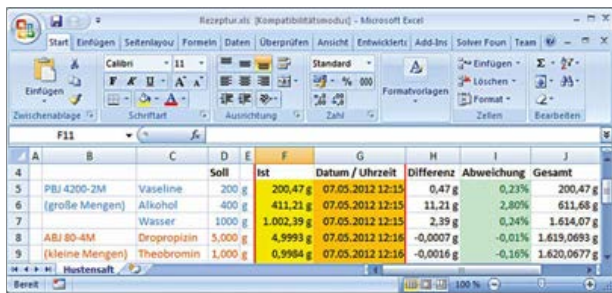

Easy transfer and editing of measuring results e.g. in Microsoft® Excel

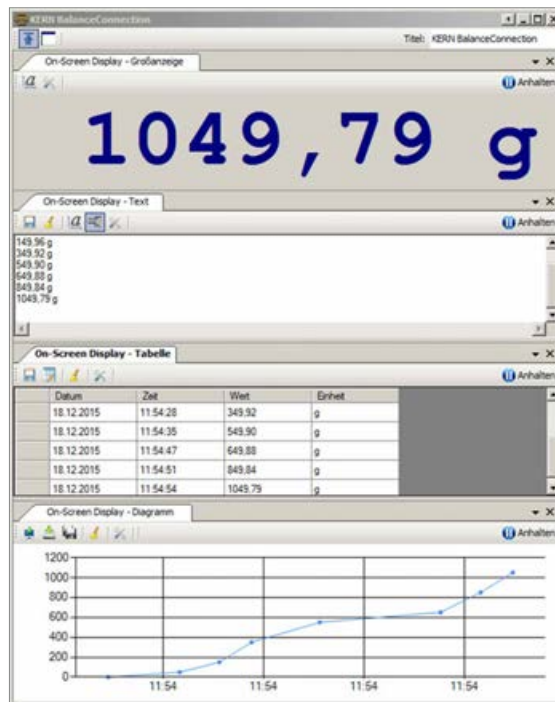

Different on-screen displays with export function

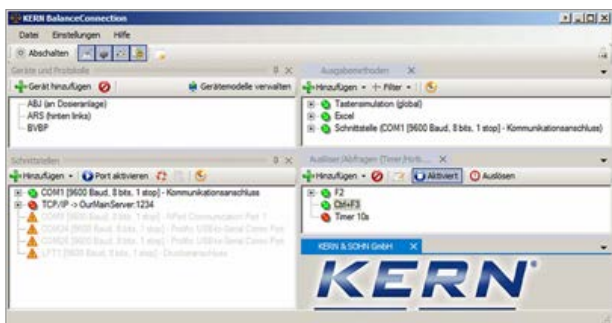

Full overview of devices, outputs, queries, interfaces, etc. shown on the output window immediately.

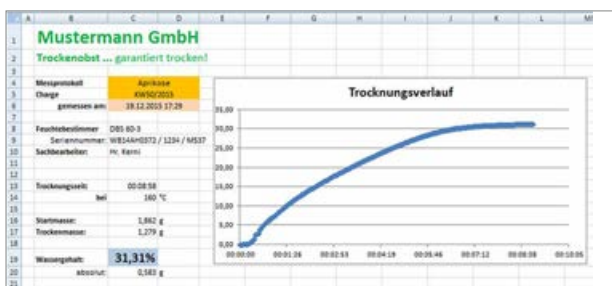

Measurement report with line chart showing a moisture analysis

Tip
 Do you have any questions? The team from our Industry 4.0 centre of expertise will be happy to help: e-mail: ITsupport@kern-sohn.com
 Or download a free demo version of the BalanceConnection software: <http://balanceconnection.kern-sohn.com/demo>

Flexible recording or transfer of measurements, particularly to Microsoft® Excel or Access

Features

- For operating systems Windows XP, Vista, 7, 8, 8.1, 10, 11
- Supports balances measuring devices with RS 232, RS 485, Bluetooth, LAN or WiFi network (TCP/UDP/IP)
- Highly flexible formatting of the output (any order, formatting and rounding), particularly recording of date and time for every value transferred, if required
- Any number of devices/interfaces can be connected, as well as simultaneous and synchronised recording of several balances
- Key-activated or time-controlled interrogation of measurements or trigger of device functions, also for continuous recording
- The interface protocols for KERN balances are already predefined (standard configuration)

- Compatible interface cable included when you order a KERN balance at the same time
- Many different transfer and recording options:
 - Microsoft® Excel/Access/Word in the foreground or background
 - Other Windows applications (through key simulation), e.g. shipping software or ERP system (SAP, Sage, etc.)
 - File recording (e.g. as text or CSV file)
 - Print out on text or label printer
 - Screen output such as large display, line chart (drying curve for moisture analyser), histogram, etc.

Benefits

- Typing errors during e.g. manual transfer are avoided
- Automatic recording, e.g. for long-term tests
- Supports GLP-compliant processes
- Can be used across different branches and applications
- Also available as a cost-optimised package with 5 licenses, **you save more than 30 %!**
- Also available immediately as a download license
- Scope of supplies: 1 CD, 1 license, KERN SCD-4.0, **€ 189,-**
- Scope of supplies: 1 CD, 5 licenses, KERN SCD-4.0S05, **€ 870,-**
- Scope of supplies: Download link for 1 license, KERN SCD-4.0-DL, **€ 189,-**

16

	Soll	Ist	Datum / Uhrzeit	Differenz	Abweichung	Gesamt		
4		200,47 g	07.05.2012 12:15	0,47 g	0,23%	200,47 g		
5	PBJ 4200-2M	Vaseline	200 g					
6	(große Mengen)	Alkohol	400 g	411,21 g	07.05.2012 12:15	11,21 g	2,80%	611,68 g
7		Wasser	1000 g	1.002,39 g	07.05.2012 12:15	2,39 g	0,24%	1.614,07 g
8	ABJ 80-4M	Dropropizin	5,000 g	4,9993 g	07.05.2012 12:16	-0,0007 g	-0,01%	1.619,0693 g
9	(kleine Mengen)	Theobromin	1,000 g	0,9984 g	07.05.2012 12:16	-0,0016 g	-0,16%	1.620,0677 g

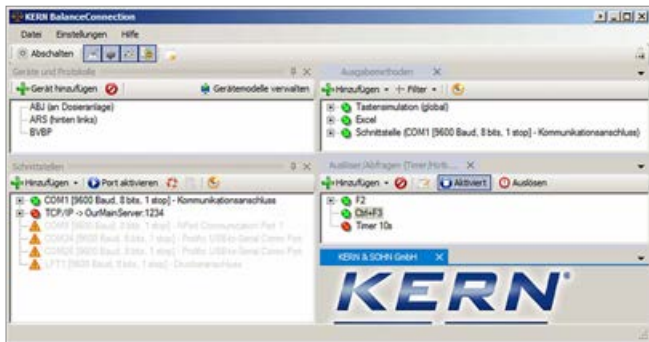
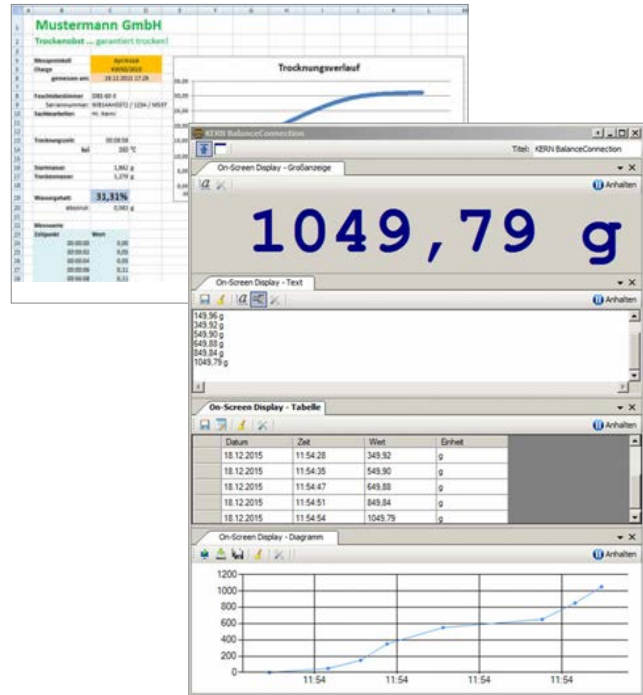

Professional and highly flexible recording or transmission of measured values, in particular also to Microsoft® Excel or Access

Features

- For operating systems Windows XP, Vista, 7, 8, 8.1, 10, 11
- Supports balances measuring devices with RS 232, RS 485, Bluetooth, LAN or WiFi network (TCP/UDP/IP)
- Highly flexible formatting of the output (any order, formatting and rounding), particularly recording of date and time for every value transferred, if required
- Any number of devices/interfaces can be connected, as well as simultaneous and synchronised recording of several balances
- Key-activated or time-controlled interrogation of measurements or trigger of device functions, also for continuous recording
- The interface protocols for KERN balances are already predefined (standard configuration)
- Compatible interface cable included when you order a KERN balance at the same time
- Many different transfer and recording options:
 - Microsoft® Excel/Access/Word in the foreground or background
 - Other Windows applications (through key simulation), e.g. shipping software or ERP system (SAP, Sage, etc.)
 - File recording (e.g. as text or CSV file)
 - Print out on text or label printer
 - Screen output such as large display, line chart (drying curve for moisture analyser), histogram, etc.

Additional features of the BalanceConnection PRO version:

- ODBC/SQL databases such as SQL Server or MySQL
- Transfer to HTTP Webservices/Web forms
- Histogram
- Enables the connection of medical balances to practice EDP systems using the device data transfer protocol (GDT) and also the HL7 protocol
- Implementation of programs/scripts using freely-definable command lines
- Command sequences
- Defining the conditions for specific events and the reaction to these events
- Filter for stability recognition (configurable value storage)
- Central configuration repository, e.g. on the network
- On-screen displays with configurable user interface for flexible balance operation

Benefits

- Ideal software where weighing data which has been collected needs to be transferred to a Windows PC
- Particularly suitable for professional integration of weighing systems into existing networks where there is a high demand for automated data transfer and further processing, for integration of databases
- Automatic recording, e.g. for long-term tests
- Supports GLP-compliant processes
- Can be used across different branches and applications
- Any number of balances can be used on one PC/workstation per licence
- Also available as a cost-optimised package with 5 licenses, **you save more than 30 %!**
- Also available immediately as a download license
- Scope of supplies:
 - 1 CD, 1 License
 - KERN SCD-4.0-PRO, € 345,-
- Scope of supplies:
 - 1 CD, 5 Licenses
 - KERN SCD-4.0-PRO5, € 1330,-
- Scope of supplies: Download link for
 - 1 License, KERN SCD-4.0-PRO-DL, € 345,-



STANDARD

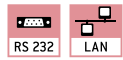

RS-232/Ethernet adapter KERN YKI-01

Adapter to connect balances, force measuring devices etc. with an RS-232 interface 2 to an IP-based Ethernet network 1. The adapter allows direct integration of measuring devices into most company networks, with automatic configuration using DHCP or statistical IP allocation. You can access the current measuring data at any time from within the whole network, without having to use additional cables. The adapter supports a wide range of configurational options using the enclosed administration software or by the web interface. The driver delivered with the goods allows you to access the measuring device with existing, non-network-compatible applications using a virtual COM port. Compatible with KERN BalanceConnection software. DIN track mount 3 or free-standing.

Scope of delivery: RS-232 Ethernet adapter with 1x Port RS-232 1, mains adapter 4, CD (driver, software, operating instructions), adhesive feet, (interface cable see page 173),

KERN YKI-01, € 345,-



STANDARD



RS-232/WiFi adapter KERN YKI-03

High-quality adapter for the wireless connection of balances, force measuring devices etc. with RS-232 interface to WiFi-enabled devices, such as tablets, laptops, Smartphones etc. In this way, where there is a physical separation or a large distance between the devices, the weighing data from one or several balances can be easily transferred without cable to a WiFi device or a network (relevant software on the WiFi device needed, not included in delivery). The adapter allows direct integration of measurement devices into most company networks, with automatic configuration using DHCP or statistical IP allocation. You can access the current measuring data at any time from within the whole network, without having to use additional cables. The adapter supports a wide range of configurational options using the enclosed administration software or by the web interface. The driver delivered with the goods allows you to access the measurement device with existing, non-network-compatible applications using a virtual COM port. Compatible with KERN Software BalanceConnection.

The adapter also has an Ethernet interface for a wired connection to an IP-based Ethernet network 1. Thanks to the screw terminals 2, the power connection can be implemented individually using individual wires or using the robust, screw-in power connector 3. Large input voltage range from 12 V–48 V. Suitable for wall mounting and DIN track mount 4 or free-standing.

Scope of delivery: RS-232/WiFi adapter, mains adapter, network cable (1 m), driver CD, (interface cable see page 173),

KERN YKI-03, € 820,-



Note: To connect to your network, you will need information from your network administrator. We recommend discussing connecting your device into your network with the administrator before you place your order.

Note: If you order a KERN balance at the same time, then the interface cable is **free of charge** (please specify balance model).

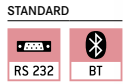

RS-232/Bluetooth adapter KERN YKI-02

Adapter for the wireless connection of balances, force measuring devices etc. with an RS-232 interface to Bluetooth devices, such as Bluetooth printers, tablets, laptops, Smartphones etc. In this way, where there is a physical separation or a large distance between the devices, the weighing data from one or several balances can be easily sent without cable and printed on a Bluetooth printer or transferred to a Bluetooth device (you would need the relevant software on the Bluetooth device, not included with the delivery). The compact adapter with its attractive design can usually be connected directly to the balance **1**, e.g. an additional interface cable would not be necessary. Bluetooth adapter will be powered by the balance (if compatible) or with the mains adapter which is supplied as standard **2**. Range up to 100 m outside, depending on obstacles, such as, walls, the sensitivity and type of antenna of the receiver. Intersections of sending and receiving lines using the DCE/DTE switch **3**. Compatible with KERN Software BalanceConnection.

Scope of delivery: RS-232/Bluetooth adapter, mains adapter (EU/UK/USA/AUS/CH) **2**, USB-A to Mini-USB-B cable **4**, gender changer **5**, driver CD, (interface cable see page 173),

KERN YKI-02, € 345,-



Note: To connect to your network, you will need information from your network administrator. We recommend discussing connecting your device into your network with the administrator before you place your order.

Note: If you order a KERN balance at the same time, then the interface cable is **free of charge** (please specify balance model).



**Large display
KERN YKD-A02**

with superior display size, digit height 3" (76 mm). Luminescent, red LED display for easy reading of weight, even from a distance or under poor lighting conditions. 6 segments, mains connection as standard (230 V, EU/GB), connection using RS-232 data interface, dimensions WxDxH 541x55x180 mm.

Suitable for series IFB, BFB, NFB, UFA, UFB,

KERN YKD-A02, € 310,-



**Signal lamp
KERN CFS-A03**

Signal lamp for visual support of weighing with tolerance range. Three-colour LED, red, green, yellow. Power supply via balance using RS-232. Total dimensions WxDxH 100x180x300 mm

Suitable for series BFB, BFN, BID, CKE, CPB-N, GAB-N, GAB-P, IFB, IFS, IOC, KFB-TM, KFN-TM, KIB-TM, NBB, NFB, NFN, SFB, UFA, UFB, UFC, UFN,

KERN CFS-A03, € 330,-



**Power supply adapter set
KERN YKA-02**

from standard EU to GB/US/AUS/CH etc. Four pieces. Ideal for devices with Class II protection (not earthed). Ideal for Euro moulded plug,

KERN YKA-02, € 35,-



**2nd RS-232 data interface
KERN CFS-A04**

separate Y cable, e.g. for simultaneous connection of a printer and a signal lamp.

Suitable for series BAN, BFB, CFS, CPB-N, GAB-N, GAB-P, IFB, KFB-TM, NFB, NFN, UFN, UFA, UFB, SFB,

KERN CFS-A04, € 38,-



**RS-232/USB adapter
KERN AFH 12**

to connect peripheral devices with USB connection, fits on all balances and measuring instruments with RS-232 port.

Please order the appropriate RS-232 interface cable for your balance at the same time, see table on page 173

Scope of delivery: Converter cable, CD with driver,

KERN AFH 12, € 95,-



**Stand (tripodal)
KERN YKP-02**

stable and robust, to elevate display device, stainless steel, height-adjustable, large three-legged adjustable foot, height of stand approx. 750–1000 mm, Factory Option.

Suitable for series BFB, BXS, BFS, BFA, BBB, BBN, BKN, IFS, IFB, KFE-TM, KXG-TM, KXS-TM, KEN-TM, NFB, NBB, SFE, UFA, UFB, UFC,

KERN YKP-02, € 220,-



**Protective dust cover
KERN ABS-A08**

For protection from dust and light (Fig. similar).

Suitable for all KERN analytical balances and precision balances with glass draught shield,

KERN ABS-A08, € 32,-



**Tare pan
KERN RFS-A02**

Made of stainless steel, which makes cleaning easy and hygienic. Ideal for weighing loose screws, small parts as well as fruit, vegetables, cheese, etc.

- W×D×H 400×300×45 mm
- Net weight approx. 554 g

KERN RFS-A02, € 75,-



**Tare pan with pan beam
KERN CH-A01N**

Made of stainless steel. Ideal for weighing loose small parts as well as fruit, vegetables etc. Max. load 30 kg. Removable tare pan which makes cleaning easy and hygienic.

Suitable for models KERN CH 15K20, HCB 20K10, HDB-N, HDB-XL

- Dimensions: tare pan, \varnothing /H 160×40 mm (dim. outside), 240×40 mm (dim. inside)
- Pan beam: W×D×H 290×240×300 mm 290×240×340 mm (incl. tare pan)
- Total net weight approx. 500 g

KERN CH-A01N, € 93,-



**Universal density set
KERN YDB-03**

Universal density set for precise and convenient density determination of liquids and solids $\leq/\geq 1$. Suitable for all current KERN analytical balances.

Scope of delivery: Beaker (\varnothing ×H 84×113 mm), thermometer, sample holder, adapter, equalising weights, volume plummet (stainless steel, 20 g), universal submersible basket for solid bodies which float and sink. The wire of the submersible basket has a diameter of 0.5 mm and therefore complies with the requirements of DIN EN ISO 1183-1 (test methods for the determination of density of non-foamed plastics), KERN YDB-03, € 380,-

Optional:
Density determination of the volume plummet, DAkkS calibration certificate with all data relating to the density and volume, KERN 962-335V, € 170,-



**Ioniser to neutralise electrostatic charge
KERN YBI-01A**

Goods to be weighed which are non-conductive, such as plastic, china, glass, etc often carry electrostatic charge. The electromagnetic field which then occurs between the goods to be weighed and the balance can cause the weighing result to be distorted by up to a gramme. Therefore, when weighing in milligrammes or even smaller increments, we recommend neutralising the electrostatic charge with the KERN AC-Korona discharge ioniser. With feet supplied with the ioniser, it can be positioned conveniently next to the balance or you can manually direct it from all sides onto a particular item to be weighed.

- Discharge of ozone 0,05 ppm/h
- Total dimensions WxDxH
115x100x60 mm (Adjustable foot retracted),
115x110x80 mm (Adjustable foot folded out)
- Net weight approx. 0,31 kg
- Mains connection 100-240 V, 50/60 Hz, AC power supply, DC 12 V, 500 mA, output,

KERN YBI-01A, € 1050,-



STANDARD
2 DAYS

**Weighing table
KERN YPS-03**

The KERN YPS-03 weighing table has been constructed to absorb vibrations and oscillations, which would otherwise distort the weighing result.

The YPS-03 weighing table consists of:

- a heavy, polished granite slab (24 kg) and is positioned on absorbing rubber components and is used as a surface on which to stand the analytical balance
- a work table, the work surface of which surrounds the slab and offers many storage options. The sturdy powder-coated steel frame has four height-adjustable feet, which can be used to accurately level the weighing table if the floor is at all uneven
- You can work in an ergonomic way at the weighing table whether you are in a standing or seated position. The inlet on the front of the table offers enough space for you to sit down and operate the scale without touching the weighing table.
- All surfaces are hygienic and easy to clean
- Suitable for all KERN analytical balances with total dimensions $\leq W \times D$ 300x400 mm
- Total dimensions WxDxH
785x600x800 mm (Height adjustable)
- Dimensions granite slab, WxDxH
300x400x80 mm
- Net weight approx. 46 kg

Ready for shipping in 2 working days. Dispatch complete on pallet, simple self-assembly. Please ask for dimensions, gross weight, shipping costs,

KERN YPS-03, € 1060,-

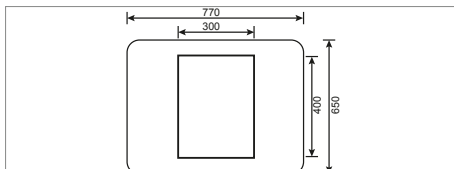

**Anti-vibration granite plates
KERN YPS-04, -05, -06**

- The KERN YPS-04, -05, -06 anti-vibration granite plates are designed to dampen shocks and vibrations that would otherwise distort the weighing results of high precision Laboratory Scales and analytical balances. Also ideal for vibration-free microscope set-up
- The anti-vibration granite plate is made of polished granite, which is supported on absorbent damping elements
- The anti-vibration granite plate can be used ergonomically while standing or sitting comfortably
- Compact size, practical for small spaces
- All surfaces are hygienic and easy to clean
- Suitable for all KERN analytical balances, precision balances and microscopes with the corresponding dimensions
- Overall dimensions, WxDxH
YPS-04: 400x450x60 mm
YPS-05: 565x450x60 mm
YPS-06: individual dimensions, according to your requirements
- Net weight approx.
YPS-04: 30 kg
YPS-05: 35 kg
YPS-06: on request

Ready for shipping in 2 working days. Dispatch complete on pallet. Please ask for dimensions, gross weight, shipping costs,

KERN YPS-04, € 760,-
KERN YPS-05, € 980,-
KERN YPS-06, on request



STANDARD



Roller conveyor KERN YRO-01/ YRO-02/ YRO-03

Through the smooth-running KERN roller conveyor attachments, KERN YRO, you can convert your platform scale into a robust measuring system for rapid and flexible weight determination in conveyor applications

Especially suitable for use in production and dispatch lines, where time means money. The goods or packages can either be weighed as they pass over the balance or, at fixed stations, heavy goods can easily be pushed onto the scale thanks to the roller conveyor and moved onto the connected roller conveyor

- Simply connect the roller conveyor attachment to a platform (e.g. KERN IFB, IFS, IXS, KFP, KXP, SXS) – done!
- Robust aluminium profile frame. The modular design means that you can easily disassemble it for cleaning or to replace individual components
- Smooth-running, hot-dip galvanised steel rollers with ball bearings
- Conductive rollers
- Suitable for use in dry environments
- Roller distance approx. 30 mm
- Direction of movement is lengthways

- Scope of delivery: 1 roller conveyor attachment (without scale)
- We are happy to adapt the roller conveyor to your scale, adjust the preload or switch-on tolerance, etc. Please ask for your individual offer, your personal KERN contact person will be happy to help you

Model	Total dimensions W×D×H	Suitable for platforms with weighing plate sizes W×D	Total net weight approx.	Price excl. of VAT ex works €
KERN	mm	mm	kg	
YRO-01	405×305×130	400×300	6	720,-
YRO-02	505×405×130	500×400	9	740,-
YRO-03	655×505×130	650×500	12	1060,-



17

TEST WEIGHTS



Weights yesterday and today

For centuries now, weight pieces have been used in scales for weighing procedures. This original purpose has now almost disappeared. Today, weights are used almost exclusively for adjusting and testing = calibration of electronic balances. They are now named "test weights" as this is their contemporary purpose.

Adjustment or calibration?

► **Adjusting** a balance means that you are intervening in the weighing system, to make sure that the display is set to show the correct nominal value. With ► **calibration** on the other hand, there is no intervention, you are testing whether the display is correct and documenting any deviation.

Testing, the right way!

The internationally valid OIML norm R111:2004 classifies test weights hierarchically in accuracy classes, where E1 is the most accurate and M3 is the least accurate weight class. With KERN you get the whole test weight range in all OIML accuracy classes E1, E2, F1, F2, M1, M2, M3.

As the test weight only becomes an ► **ISO 9000ff**-compliant test instrument when its accuracy has been proven, we offer the appropriate ► **DAkkS Calibration certificate** or verification certificate (in connection with a box) for all KERN test weights. For further details see chapter *DAkkS Calibration Service*.







KERN offers you the appropriate test weight package for your balance, consisting of the test weight, box and DAkkS-calibration certificate, as proof of its accuracy. The best prerequisite for a correct adjustment or checking of your scales.

► **See the glossary on page 223–225**

Classes of accuracy of test weights E, F, M and their general relation to the types of balances:

- E1 Test weights for customers who require a high degree of accuracy for the most demanding applications. For high-resolution balances with $d > 1,000,000$ Use recommended with DAkkS calibration certificate only.
- E2 Most accurate test weights for high resolution analytical balances of verification class I $\geq 100,000$ e
- F1 Test weights for analytical balances/precision balances for verification class I/II $\leq 100,000$ e
- F2 Test weights for precision balances of verification class II $\leq 30,000$ e
- M1 Test weights for industrial and commercial scales of verification class III $\leq 10,000$ e

The appropriate test weight for your new KERN balance can also be found directly in the accessories of the balance in our webshop.

KERN DAkkS delivery times & shipping type	Total weight ≤ 30 kg (gross weight, incl. packaging)	Total weight > 30 kg (gross weight, incl. packaging)
DAkkS standard service Class E2 – M3	 4 DAYS	 4 DAYS
DAkkS standard service Class E1, 1 mg – 500 mg and recalibration 1 g – 10 kg with a known volume	 10 DAYS	 10 DAYS
Class E1, ≥ 1 g, incl. volume determination (new weights)	 15 DAYS	 15 DAYS
Special weights, Newton weights, heavy duty weights, weight carriers, containers for individual weight sets etc.	on request	

Just lean back – we have just the right test weight for your measuring device

KERN offers you a large range of OIML test weights, which you can use at any time to quickly and reliably check your balance, force-measuring device, etc.. From milligram weights to tonne weights, from the classic OIML design to special weights which are specifically manufactured to your specifications, we can offer you just the right test weight, and naturally the weights have the relevant DAkkS calibration certificate or factory calibration certificate.

On the following pages you will see a selection of standard test weights for OIML error limit classes E1, E2, F1, F2, M1, M2, M3.

We will be happy to manufacture special (large) weights, weight containers, Newton weights or weights with special weight values for you on request. Our test weights product specialist will be happy to give you expert, comprehensive advice.

Note: In our webshop you can conveniently select test weights for your scale that have been calculated and matched to your accuracy requirements and intended use – with or without calibration. We will be happy to determine the minimum sample quantity according to USP Chapter <41> and recommend a KERN Safety Set especially designed for your scale.



Marking – never lose track again!

With the large variety of test equipment used then it is essential that they are identified accurately. We can help you with this and mark your test weights according to your ideas by etching or with impact numbers. Whether it's letters, numbers, your logo, barcodes or something else – it's your choice. Our product specialist "Test weights" will gladly help you with any questions about this service, prices, etc.

PREMIUM⁺ TEST WEIGHTS

Note: Our highly-accurate OIML test weights are also available as **PREMIUM⁺ test weights** for that extra level of safety. Thanks to the most modern manufacturing technology, these test weights can also be adjusted within the specified error limit classes (= tolerances).

I.e. this means that these **PREMIUM⁺ test weights** have a significantly longer service life, thanks this guaranteed positive tolerance. This is of particular benefit with intensive use of the test weights.

For all the details on this **PREMIUM⁺ service** please see www.kern-lab.com/premium+ or look at the weight you want in our online shop at www.kern-sohn.com





KERN SAFETY SETS

All the security you need!

“KERN Safety Sets” which have been specially developed, put together and contain the right test weights to test and monitor your balance. They each consist of a test weight for checking the sensitivity, i.e. the correct adjustment of your scale, and a small test weight for checking at the lower end of the weighing range, the so-called minimum sample weight. As an option, the “KERN Safety Set” has space for another test weight, for testing your balance at a weight which is relevant for you.

Useful accessories which have been selected to suit that particular “KERN Safety Set”, such as, for example, special gloves, tweezers, weight grips, brushes, etc., will assist you in handling your test weights properly. Stored in the practical protective case next to your balance, you can check and ensure the high precision of your balance at any time.

Just ask our test weight product specialist, they will be happy to recommend the right “KERN Safety Set” for your balance. You can also find the matching “KERN Safety Set” for each model on the Internet at www.kern-sohn.com



Product Specialist Test Weights

Taras Mikitisin
Tel. +49 7433 9933- 143
mikitisin@kern-sohn.com

Our KERN weight cases at a glance:

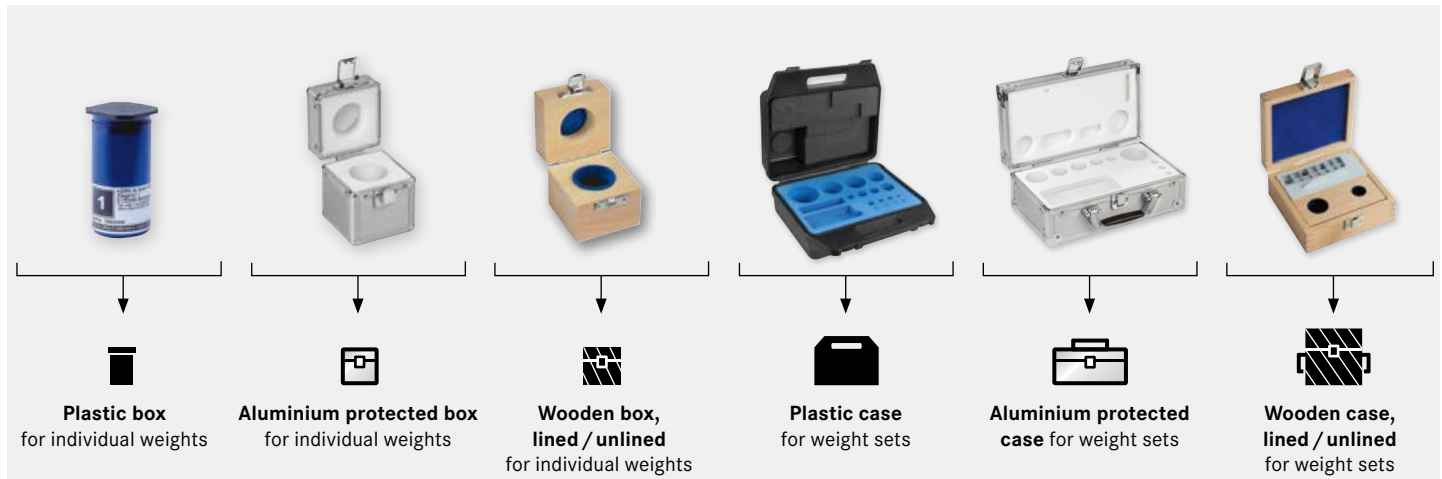

It's your choice!

To protect your test weights we can offer you an appropriate weight case. If there are no legal or normative specifications, then you have the choice between plastic, aluminium protected or wood. The available weight cases are shown as a symbol in the test weight tables on the following pages. This way you have all the materials, versions, sizes and prices at a glance, listed in a concise way.

It's so easy to order your suitable test weight



According to your safety requirements or the specifications of your QM system, you select the test weight with the appropriate weight value and the required tolerance (see page 186/187).

We offer many test weights in different designs, giving you complete freedom to decide which test weights you want to use for your application. It goes without saying that all our test weights comply with the OIML R111:2004 directive.

To protect your high-quality test equipment, we offer you cases in various designs. From low-priced plastic weight cases to aluminium protected weight cases to classic, high-quality wooden weight cases.

A DAkkS calibration certificate – the auditor's favourite! With this certificate you provide the standard-compliant proof of all important values of your test equipment and are on the safe side when operating and testing your measuring equipment.

1		2		3			4						
Weight	Tol +/- mg	Individual weights, compact shape		Individual weights, knob shape		Plastic box	Aluminium protected box	Wooden box	DAkkS certificate				
		KERN	€	KERN	€	KERN	€	KERN	€	KERN	€	KERN	€
1 g	0,03	316-01	36,-	317-01	52,-	317-020-400	4,-	317-010-600	14,-	317-010-100	26,-	962-331	30,-
2 g	0,04	316-02	36,-	317-02	53,-	317-020-400	4,-	317-020-600	14,-	317-020-100	26,-	962-332	30,-
5 g	0,05	316-03	37,-	317-03	56,-	317-030-400	4,-	317-030-600	14,-	317-030-100	26,-	962-333	30,-
10 g	0,06	316-04	38,-	317-04	60,-	317-040-400	4,-	317-040-600	14,-				30,-
20 g	0,08	316-05	43,-	317-05	68,-	317-050-400	4,-						
		316-06	46,-	317-06	73,-								

1		2		3		4			
Weight		Knob shape in plastic case		Knob shape in aluminium protected case		Knob shape in wooden case		DAkkS certificate	
		KERN	€	KERN	€	KERN	€	KERN	€
1 mg - 500 mg		338-22	143,-	338-226	183,-			962-450	110,-
1 mg - 50 g		333-024	345,-	333-026	365,-	333-02	370,-	962-401	184,-
1 mg - 100 g		333-034	385,-	333-036	400,-	333-03	405,-	962-402	196,-
1 mg - 200 g		333-044	450,-	333-046	465,-	333-04	470,-	962-403	220,-
1 mg - 500 g		333-054	510,-	333-056	530,-	333-05	540,-	962-404	230,-
1 mg - 1 kg		333-064	630,-	333-066	650,-	333-06	660,-	962-405	240,-
1 mg - 2 kg		333-074	890,-	333-076					

Selection of the appropriate test weight for your balance

A balance can never be more accurate than the test weight that is used to adjust it, it all depends on its tolerance. **The accuracy of the test weight should correspond to the readout [d] of the balance, or rather be more precise.**

Nominal weight value is shown in adjust mode "CAL" in the balance display. Given a choice, the heaviest weight is the most suitable for accurate measurement.

Once accuracy and nominal weight value are specified, the suitable test weight is selected according to the tolerances "Tol" of the individual accuracy classes E2 - M3, see column "Tol ± mg" at the respective weight and table at page 187.

Example:





Balance with weighing range [Max] 2000 g = 2 kg
and readout [d] = 0,01 g = 10 mg

- The accuracy of the required test weight is determined by readout [d]: max. tolerance ± 10 mg.
- Displayed weight size on "CAL" mode: 1000 g or 2000 g. The required test weight has a 2 kg weight size.
- Suitable test weights with ± 10 mg tolerance and 2 kg weight size, can be found in accuracy class F1. KERN-No 326-12 or KERN-No 327-12, see page 193.

Exception: analytical balances (readout [d] ≤ 0,1 mg):

E1 test weights are recommended. Depending on the safety requirements, E2 test weights with a DAkkS calibration certificate will also be sufficient.

From finely turned to polished stainless steel – the right test weight for every situation

Test weight					
Features	→ Knob shape with lifting knob, polished stainless steel	→ Compact shape with carrying grip, polished stainless steel	→ Knob shape with lifting knob, polished stainless steel	→ ECO shape, polished stainless steel	→ Knob shape with lifting knob, finely turned stainless steel
Conforms to OIML:R111	↓ yes	↓ yes	↓ yes	↓ yes	↓ yes
Available classes	E1, E2	E2	F1	F1	F2, M1
Upper surface	polished	polished	polished	polished	finely turned
Material	Stainless steel	Stainless steel	Stainless steel	Stainless steel	Stainless steel
Adjusting cavity	no	no	yes	yes, from 50 g, readjustment can only be carried out by KERN	yes, from 20 g
Marking (Milligram weights, generally none)	none	none	Nominal value, etched	Nominal value, etched	F2: Class + nominal value, etched; M1: Class + nominal value, adopted
Verification possible	yes (E2)	yes	yes	no	yes (M1)
Checking equipment for verification purposes	approved (E2)	approved	approved	approved	approved (M1)
Ideal as checking equipment in QM systems (e.g. ISO 9000 ff)	yes	yes	yes	yes	yes
Benefits	<ul style="list-style-type: none"> • High-quality test weight for analytical and precision balances • Highly-refined surface • Ideal shape of the top for good grip 	<ul style="list-style-type: none"> • Affordable test weight for analytical and precision balances • Highly refined surface 	<ul style="list-style-type: none"> • Ideal, high-quality test weight for precision balances • No visible adjustment chamber • High long-term stability • Ideal shape of the top for good grip 	<ul style="list-style-type: none"> • Affordable test weight for analytical and precision balances • Highly refined surface • Optimum shape of the top for good grip 	<ul style="list-style-type: none"> • Ideal test weight for commercial and industrial scales • Ideal shape of the top for good grip

Composition table, valid for all KERN test weight sets from 1 mg

Individual weights per set	→	1	2	2	5	10	20	20	50	100	200	200	500	1	2	2	5	10	10	20	20	50	100	200	200	500	1	2	2	5	10	
Test weight set	↓	mg	mg	mg	mg	mg	mg	mg	mg	mg	mg	mg	mg	g	g	g	g	g	g	g	g	g	g	g	g	g	kg	kg	kg	kg	kg	
1 mg-500 mg	Total weight	1,11 g																														
1 mg-50 g														111,11 g																		
1 mg-100 g													211,11 g																			
1 mg-200 g													611,11 g																			
1 mg-500 g													1.111,11 g																			
1 mg-1 kg													2.111,11 g																			
1 mg-2 kg													6.111,11 g																			
1 mg-5 kg													11.111,11 g																			
1 mg-10 kg													21.111,11 g																			

The key points from the OIML norm R111:2004

OIML (Organisation Internationale de Métrologie Légale) has established the exact metrological requirements for weights in verified applications in approx. 100 states all over the world. The OIML recommendation R111 (2004 Edition) for weights relates to sizes 1 mg - 5000 kg. Statements are made on the accuracy, materials, geometric shape, marking and storage of the weights.

Error limits for weights of classes E1 to M3

The error limit classes are in fixed hierarchical levels in the proportion of 1:3, where E1 is the most accurate and M3 is the least accurate weight class. When testing weights with other weights, the correct test class is the next highest class.

Error limit classes (= tolerances)

The values given in the table below (tolerances $\pm \dots$ mg) are the respective permitted fabrication tolerances. They are to be equal to the ► **measuring uncertainty** of the weight, if no ► **DAkkS calibration certificate** is available.

Conventional mass

The problem is the air buoyancy, which makes the weight appear lighter. In order to avoid this "distortion" in daily use, all weights are adjusted to the unit specifications as given in R111, e.g. it is accepted that: material density of the weights is 8000 kg/m³, air density is 1.2 kg/m³ and measuring temperature is 20 °C.

KERN test weights: Unless otherwise specified, they conform to OIML R111:2004 in every detail.

► *See the glossary, page 223–225*

Nominal value	OIML R111:2004 Maximum permissible errors for weights = permissible tolerances "Tol \pm mg"						
	E1	E2	F1	F2	M1	M2	M3
1 mg	$\pm 0,003$ mg	$\pm 0,006$ mg	$\pm 0,020$ mg	$\pm 0,06$ mg	$\pm 0,20$ mg	-	-
2 mg	$\pm 0,003$ mg	$\pm 0,006$ mg	$\pm 0,020$ mg	$\pm 0,06$ mg	$\pm 0,20$ mg	-	-
5 mg	$\pm 0,003$ mg	$\pm 0,006$ mg	$\pm 0,020$ mg	$\pm 0,06$ mg	$\pm 0,20$ mg	-	-
10 mg	$\pm 0,003$ mg	$\pm 0,008$ mg	$\pm 0,025$ mg	$\pm 0,08$ mg	$\pm 0,25$ mg	-	-
20 mg	$\pm 0,003$ mg	$\pm 0,010$ mg	$\pm 0,03$ mg	$\pm 0,10$ mg	$\pm 0,3$ mg	-	-
50 mg	$\pm 0,004$ mg	$\pm 0,012$ mg	$\pm 0,04$ mg	$\pm 0,12$ mg	$\pm 0,4$ mg	-	-
100 mg	$\pm 0,005$ mg	$\pm 0,016$ mg	$\pm 0,05$ mg	$\pm 0,16$ mg	$\pm 0,5$ mg	$\pm 1,6$ mg	-
200 mg	$\pm 0,006$ mg	$\pm 0,020$ mg	$\pm 0,06$ mg	$\pm 0,20$ mg	$\pm 0,6$ mg	$\pm 2,0$ mg	-
500 mg	$\pm 0,008$ mg	$\pm 0,025$ mg	$\pm 0,08$ mg	$\pm 0,25$ mg	$\pm 0,8$ mg	$\pm 2,5$ mg	-
1 g	$\pm 0,010$ mg	$\pm 0,03$ mg	$\pm 0,10$ mg	$\pm 0,3$ mg	$\pm 1,0$ mg	$\pm 3,0$ mg	± 10 mg
2 g	$\pm 0,012$ mg	$\pm 0,04$ mg	$\pm 0,12$ mg	$\pm 0,4$ mg	$\pm 1,2$ mg	$\pm 4,0$ mg	± 12 mg
5 g	$\pm 0,016$ mg	$\pm 0,05$ mg	$\pm 0,16$ mg	$\pm 0,5$ mg	$\pm 1,6$ mg	$\pm 5,0$ mg	± 16 mg
10 g	$\pm 0,020$ mg	$\pm 0,06$ mg	$\pm 0,20$ mg	$\pm 0,6$ mg	$\pm 2,0$ mg	$\pm 6,0$ mg	± 20 mg
20 g	$\pm 0,025$ mg	$\pm 0,08$ mg	$\pm 0,25$ mg	$\pm 0,8$ mg	$\pm 2,5$ mg	$\pm 8,0$ mg	± 25 mg
50 g	$\pm 0,03$ mg	$\pm 0,10$ mg	$\pm 0,3$ mg	$\pm 1,0$ mg	$\pm 3,0$ mg	± 10 mg	± 30 mg
100 g	$\pm 0,05$ mg	$\pm 0,16$ mg	$\pm 0,5$ mg	$\pm 1,6$ mg	$\pm 5,0$ mg	± 16 mg	± 50 mg
200 g	$\pm 0,10$ mg	$\pm 0,3$ mg	$\pm 1,0$ mg	$\pm 3,0$ mg	± 10 mg	± 30 mg	± 100 mg
500 g	$\pm 0,25$ mg	$\pm 0,8$ mg	$\pm 2,5$ mg	$\pm 8,0$ mg	± 25 mg	± 80 mg	± 250 mg
1 kg	$\pm 0,5$ mg	$\pm 1,6$ mg	$\pm 5,0$ mg	± 16 mg	± 50 mg	± 160 mg	± 500 mg
2 kg	$\pm 1,0$ mg	$\pm 3,0$ mg	± 10 mg	± 30 mg	± 100 mg	± 300 mg	$\pm 1\ 000$ mg
5 kg	$\pm 2,5$ mg	$\pm 8,0$ mg	± 25 mg	± 80 mg	± 250 mg	± 800 mg	$\pm 2\ 500$ mg
10 kg	$\pm 5,0$ mg	± 16 mg	± 50 mg	± 160 mg	± 500 mg	$\pm 1\ 600$ mg	$\pm 5\ 000$ mg
20 kg	± 10 mg	± 30 mg	± 100 mg	± 300 mg	$\pm 1\ 000$ mg	$\pm 3\ 000$ mg	± 10 g
50 kg	± 25 mg	± 80 mg	± 250 mg	± 800 mg	$\pm 2\ 500$ mg	$\pm 8\ 000$ mg	± 25 g
100 kg	-	± 160 mg	± 500 mg	$\pm 1\ 600$ mg	$\pm 5\ 000$ mg	± 16 g	± 50 g
200 kg	-	± 300 mg	$\pm 1\ 000$ mg	$\pm 3\ 000$ mg	± 10 g	± 30 g	± 100 g
500 kg	-	± 800 mg	$\pm 2\ 500$ mg	$\pm 8\ 000$ mg	± 25 g	± 80 g	± 250 g
1 000 kg	-	$\pm 1\ 600$ mg	$\pm 5\ 000$ mg	± 16 g	± 50 g	± 160 g	± 500 g
2 000 kg	-	-	± 10 g	± 30 g	± 100 g	± 300 g	$\pm 1\ 000$ g
5 000 kg	-	-	± 25 g	± 80 g	± 250 g	± 800 g	$\pm 2\ 500$ g

Test weights and boxes

Class E1



Milligram weights, wire shape

Individual weights, knob shape

Wooden box, for milligram weights



Plastic box, lined,
for individual weights
≤ 50 g

Plastic box, lined,
for individual weights
≥ 100 g

Wooden box, lined,
for individual weights ≤ 500 g

Wooden box, lined,
for individual weights ≥ 1 kg



Milligram weight set in plastic box (308-42)

Milligram weight set in aluminium protected box, lined (308-426)

Plastic case, lined, for weight sets, compact shape/knob shape

Aluminium protected case, lined, for weight sets, knob shape

Wooden case, lined, for weight sets, knob shape

Class E1 • Milligram weights, wire shape

Test weight material: stainless steel

Weight	Tol +/- mg	Milligram weight, wire shape		Plastic box		Aluminium protected box		Wooden box		DAkkS certificate	
		KERN	€	KERN	€	KERN	€	KERN	€	KERN	€
1 mg	0,003	308-31	89,-	347-009-400	2,-	317-009-600	15,-	338-090-200	27,-	962-251	64,-
2 mg	0,003	308-32	89,-	347-009-400	2,-	317-009-600	15,-	338-090-200	27,-	962-252	64,-
5 mg	0,003	308-33	89,-	347-009-400	2,-	317-009-600	15,-	338-090-200	27,-	962-253	64,-
10 mg	0,003	308-34	89,-	347-009-400	2,-	317-009-600	15,-	338-090-200	27,-	962-254	64,-
20 mg	0,003	308-35	89,-	347-009-400	2,-	317-009-600	15,-	338-090-200	27,-	962-255	64,-
50 mg	0,004	308-36	89,-	347-009-400	2,-	317-009-600	15,-	338-090-200	27,-	962-256	64,-
100 mg	0,005	308-37	89,-	347-009-400	2,-	317-009-600	15,-	338-090-200	27,-	962-257	64,-
200 mg	0,006	308-38	89,-	347-009-400	2,-	317-009-600	15,-	338-090-200	27,-	962-258	64,-
500 mg	0,008	308-39	89,-	347-009-400	2,-	317-009-600	15,-	338-090-200	27,-	962-259	64,-

Class E1 • Individual weights, knob shape

Test weight material: stainless steel polished

Weight	Tol +/- mg	Individual weight, knob shape		Plastic box		Aluminium protected box		Wooden box		DAkkS certificate Initial calibration*		DAkkS certificate Recalibration	
		KERN	€	KERN	€	KERN	€	KERN	€	KERN	€	KERN	€
1 g	0,010	307-01	101,-	317-020-400	4,80	317-010-600	15,-	317-010-100	26,-	963-231	235,-	962-231 R	72,-
2 g	0,012	307-02	110,-	317-020-400	4,80	317-020-600	18,-	317-020-100	27,-	963-232	235,-	962-232 R	72,-
5 g	0,016	307-03	113,-	317-030-400	4,80	317-030-600	16,-	317-030-100	28,-	963-233	235,-	962-233 R	72,-
10 g	0,020	307-04	122,-	317-040-400	4,80	317-040-600	16,-	317-040-100	27,-	963-234	235,-	962-234 R	72,-
20 g	0,025	307-05	129,-	317-050-400	4,80	317-050-600	16,-	317-050-100	31,-	963-335	210,-	962-235 R	72,-
50 g	0,030	307-06	153,-	317-060-400	6,-	317-060-600	15,-	317-060-100	31,-	963-236	235,-	962-236 R	72,-
100 g	0,050	307-07	192,-	317-070-400	8,-	317-070-600	15,-	317-070-100	33,-	963-237	235,-	962-237 R	72,-
200 g	0,100	307-08	235,-	317-080-400	7,70	317-080-600	15,-	317-080-100	33,-	963-238	235,-	962-238 R	72,-
500 g	0,250	307-09	310,-	317-090-400	8,50	317-090-600	20,-	317-090-100	39,-	963-239	235,-	962-239 R	72,-
1 kg	0,500	307-11	495,-	317-110-400	10,-	317-110-600	28,-	317-110-100	63,-	963-241	235,-	962-241 R	72,-
2 kg	1,000	307-12	700,-	317-120-400	13,-	317-120-600	34,-	317-120-100	65,-	963-242	520,-	962-242 R	89,-
5 kg	2,500	307-13	1200,-	317-130-400	25,-	317-130-600	56,-	317-130-100	99,-	963-243	520,-	962-243 R	89,-
10 kg	5,000	307-14	1850,-	317-140-400	25,-	317-140-600	79,-	317-140-100	115,-	963-244	520,-	962-244 R	89,-
20 kg	10,000	307-15	4960,-	-	-	317-150-600	111,-	317-150-100	630,-	963-245	1280,-	962-245 R	720,-
50 kg	25,000	307-16	8500,-	-	-	317-160-600	320,-	317-160-100	880,-	963-246	1500,-	962-246 R	800,-

* For E1 weights > 1g at the point of initial calibration, a volume determination will be carried out in accordance with OIML:R111. When recalibrating, this is not required.

Class E1 • Weight sets, knob shape

Test weight material: stainless steel polished

Weight set	Knob shape in plastic case		Knob shape in aluminium protected case		Knob shape in wooden case		DAkkS certificate Initial calibration*		DAkkS certificate Recalibration	
	KERN	€	KERN	€	KERN	€	KERN	€	KERN	€
1 mg - 500 mg	308-42	940,-	308-426	910,-			962-250	415,-	962-250 R	465,-
1 mg - 50 g	303-024	1630,-	303-026	1650,-	303-02	1680,-	963-201	1330,-	962-201 R	770,-
1 mg - 100 g	303-034	1820,-	303-036	1820,-	303-03	1870,-	963-202	1450,-	962-202 R	790,-
1 mg - 200 g	303-044	2140,-	303-046	2160,-	303-04	2190,-	963-203	1670,-	962-203 R	870,-
1 mg - 500 g	303-054	2470,-	303-056	2490,-	303-05	2520,-	963-204	1770,-	962-204 R	910,-
1 mg - 1 kg	303-064	3090,-	303-066	3180,-	303-06	3050,-	963-205	1890,-	962-205 R	980,-
1 mg - 2 kg	303-074	4370,-	303-076	4350,-	303-07	4460,-	963-206	2460,-	962-206 R	1040,-
1 mg - 5 kg	303-084	5570,-	303-086	5610,-	303-08	5770,-	963-207	2750,-	962-207 R	1080,-
1 mg - 10 kg	-	-	303-096	7540,-	303-09	7690,-	963-208	3130,-	962-208 R	1120,-
1 g - 50 g	304-024	900,-	304-026	920,-	304-02	950,-	963-215	960,-	962-215 R	340,-
1 g - 100 g	304-034	1070,-	304-036	1090,-	304-03	1120,-	963-216	1050,-	962-216 R	370,-
1 g - 200 g	304-044	1490,-	304-046	1510,-	304-04	1540,-	963-217	1280,-	962-217 R	445,-
1 g - 500 g	304-054	1800,-	304-056	1820,-	304-05	1850,-	963-218	1390,-	962-218 R	490,-
1 g - 1 kg	304-064	2210,-	304-066	2230,-	304-06	2290,-	963-219	1520,-	962-219 R	520,-
1 g - 2 kg	304-074	3570,-	304-076	3590,-	304-07	3650,-	963-220	2130,-	962-220 R	600,-
1 g - 5 kg	304-084	4670,-	304-086	4690,-	304-08	4790,-	963-221	2500,-	962-221 R	620,-
1 g - 10 kg	-	-	304-096	6490,-	304-09	6610,-	963-222	2910,-	962-222 R	670,-

Test weights and boxes

Class E2



Milligram weights, flat polygonal sheet



Individual weights, compact shape



Individual weights, knob shape



Plastic box, lined, for individual weights ≤ 50 g



Plastic box, lined, for individual weights ≥ 100 g



Aluminium protected box, lined, for individual weights



Wooden box, lined, for individual weights ≤ 500 g



Wooden box, lined, for individual weights ≥ 1 kg



Milligram weight set in plastic box (318-22)



Milligram weight set in aluminium protected box, lined (318-226)



Plastic case, lined, for weight sets, compact shape/ knob shape





Aluminium protected case, lined, for weight sets, compact shape/ knob shape



Wooden case, lined, for weight sets, compact shape/ knob shape



Class E2 · Milligram weights, flat polygonal sheet

Test weight material: stainless steel

Weight	Tol +/- mg	Milligram weight, flat polygonal sheet		Plastic box		Aluminium protected box		Wooden box		DAkkS certificate	
		KERN	€	KERN 	€	KERN 	€	KERN 	€	KERN	€
1 mg	0,006	318-01	29,-	347-009-400	2,-	317-009-600	15,-	338-090-200	27,-	962-351	31,-
2 mg	0,006	318-02	29,-	347-009-400	2,-	317-009-600	15,-	338-090-200	27,-	962-352	31,-
5 mg	0,006	318-03	29,-	347-009-400	2,-	317-009-600	15,-	338-090-200	27,-	962-353	31,-
10 mg	0,008	318-04	29,-	347-009-400	2,-	317-009-600	15,-	338-090-200	27,-	962-354	31,-
20 mg	0,010	318-05	29,-	347-009-400	2,-	317-009-600	15,-	338-090-200	27,-	962-355	31,-
50 mg	0,012	318-06	29,-	347-009-400	2,-	317-009-600	15,-	338-090-200	27,-	962-356	31,-
100 mg	0,016	318-07	29,-	347-009-400	2,-	317-009-600	15,-	338-090-200	27,-	962-357	31,-
200 mg	0,020	318-08	29,-	347-009-400	2,-	317-009-600	15,-	338-090-200	27,-	962-358	31,-
500 mg	0,025	318-09	29,-	347-009-400	2,-	317-009-600	15,-	338-090-200	27,-	962-359	31,-





Class E2 · Individual weights, compact shape or knob shape

Test weight material: stainless steel polished

Weight	Tol +/- mg	Individual weights, compact shape		Individual weights, knob shape		Plastic box		Aluminium protected box		Wooden box		DAkkS certificate	
		KERN	€	KERN	€	KERN 	€	KERN 	€	KERN 	€	KERN	€
1 g	0,03	316-01	39,-	317-01	59,-	317-020-400	4,80	317-010-600	15,-	317-010-100	26,-	962-331	31,-
2 g	0,04	316-02	39,-	317-02	60,-	317-020-400	4,80	317-020-600	18,-	317-020-100	27,-	962-332	31,-
5 g	0,05	316-03	40,-	317-03	63,-	317-030-400	4,80	317-030-600	16,-	317-030-100	28,-	962-333	31,-
10 g	0,06	316-04	41,-	317-04	67,-	317-040-400	4,80	317-040-600	16,-	317-040-100	27,-	962-334	31,-
20 g	0,08	316-05	47,-	317-05	76,-	317-050-400	4,80	317-050-600	16,-	317-050-100	31,-	962-335	31,-
50 g	0,10	316-06	51,-	317-06	80,-	317-060-400	6,-	317-060-600	15,-	317-060-100	31,-	962-336	31,-
100 g	0,16	316-07	57,-	317-07	88,-	317-070-400	8,-	317-070-600	15,-	317-070-100	33,-	962-337	39,-
200 g	0,30	316-08	67,-	317-08	114,-	317-080-400	7,70	317-080-600	15,-	317-080-100	33,-	962-338	39,-
500 g	0,80	316-09	108,-	317-09	193,-	317-090-400	8,50	317-090-600	20,-	317-090-100	39,-	962-339	39,-
1 kg	1,60	316-11	159,-	317-11	285,-	317-110-400	10,-	317-110-600	28,-	317-110-100	63,-	962-341	39,-
2 kg	3,00	316-12	275,-	317-12	440,-	317-120-400	13,-	317-120-600	34,-	317-120-100	65,-	962-342	48,-
5 kg	8,00	316-13	455,-	317-13	660,-	317-130-400	25,-	317-130-600	56,-	317-130-100	99,-	962-343	48,-
10 kg	16,00	316-14	700,-	317-14	990,-	317-140-400	25,-	317-140-600	79,-	317-140-100	115,-	962-344	48,-
20 kg	30,00	-	-	317-15	2570,-	-	-	317-150-600	111,-	317-150-100	630,-	962-345	62,-
50 kg	80,00	-	-	317-16	5390,-	-	-	317-160-600	320,-	317-160-100	880,-	962-346	71,-

Class E2 · Weight sets, compact shape or knob shape

Test weight material: Milligram weights stainless steel, individual weights: polished stainless steel

Weight sets	Compact shape in plastic case		Knob shape in plastic case		Knob shape in aluminium protected case		Knob shape in wooden case		DAkkS certificate	
	KERN 	€	KERN 	€	KERN 	€	KERN 	€	KERN	€
1 mg - 500 mg	318-22	365,-	-	-	318-226	420,-	-	-	962-350	215,-
1 mg - 50 g	-	-	313-024	930,-	313-026	940,-	313-02	970,-	962-301	350,-
1 mg - 100 g	-	-	313-034	1010,-	313-036	1020,-	313-03	1060,-	962-302	380,-
1 mg - 200 g	-	-	313-044	1220,-	313-046	1240,-	313-04	1270,-	962-303	445,-
1 mg - 500 g	-	-	313-054	1360,-	313-056	1380,-	313-05	1480,-	962-304	470,-
1 mg - 1 kg	-	-	313-064	1690,-	313-066	1710,-	313-06	1790,-	962-305	500,-
1 mg - 2 kg	-	-	313-074	2560,-	313-076	2590,-	313-07	2650,-	962-306	550,-
1 mg - 5 kg	-	-	313-084	3220,-	313-086	3260,-	313-08	3410,-	962-307	590,-
1 mg - 10 kg	-	-	-	-	313-096	4360,-	313-09	4500,-	962-308	630,-
1 g - 50 g	312-024	425,-	314-024	610,-	314-026	630,-	314-02	650,-	962-315	145,-
1 g - 100 g	312-034	485,-	314-034	680,-	314-036	700,-	314-03	740,-	962-316	173,-
1 g - 200 g	312-044	600,-	314-044	870,-	314-046	890,-	314-04	940,-	962-317	230,-
1 g - 500 g	312-054	710,-	314-054	1070,-	314-056	1090,-	314-05	1160,-	962-318	260,-
1 g - 1 kg	312-064	970,-	314-064	1370,-	314-066	1390,-	314-06	1470,-	962-319	290,-
1 g - 2 kg	312-074	1350,-	314-074	2250,-	314-076	2280,-	314-07	2340,-	962-320	355,-
1 g - 5 kg	312-084	1790,-	314-084	2910,-	314-086	2950,-	314-08	3100,-	962-321	405,-
1 g - 10 kg	-	-	-	-	314-096	4020,-	314-09	4190,-	962-322	440,-

Note

Our highly-accurate OIML test weights are also available as **Premium+** weights for that extra level of safety. See all details page 183 or on www.kern-lab.com/premium+

Test weights and boxes

Class F1



Milligram weights,
flat polygonal sheet



Individual weights/
Weight sets,
ECO shape



Individual weights/
Weight sets,
knob shape



Test weights (10 - 50 kg),
polished stainless steel,
KERN 327-141 ff, optional:
Wooden box



Block weight,
polished stainless steel



Plastic box,
lined, for
individual
weights
≤ 200 g



Plastic box,
lined, for
individual
weights
≥ 500 g



Aluminium protected box, lined,
for individual weights



Wooden box, lined,
for individual weights ≤ 500 g



Wooden box, lined,
for individual weights ≥ 1 kg



Milligram weight
set in plastic box
(328-22)



Milligram weight
set in aluminium
protected box,
lined (328-226)



Plastic case, lined
for weight sets, ECO shape/
knob shape





Aluminium protected case, lined,
for weight sets ECO shape/
knob shape



Wooden case, lined,
for weight sets ECO shape/
knob shape



Class F1 - Milligram weights, flat polygonal sheet

Test weight material: stainless steel

Weight	Tol +/- mg	Milligram weight, flat polygonal sheet		Plastic box		Aluminium protected box		Wooden box		DAkkS certificate	
		KERN	€	KERN 	€	KERN 	€	KERN 	€	KERN	€
1 mg	0,020	328-01	13,-	347-009-400	2,-	317-009-600	15,-	338-090-200	27,-	962-451	20,-
2 mg	0,020	328-02	13,-	347-009-400	2,-	317-009-600	15,-	338-090-200	27,-	962-452	20,-
5 mg	0,020	328-03	13,-	347-009-400	2,-	317-009-600	15,-	338-090-200	27,-	962-453	20,-
10 mg	0,025	328-04	13,-	347-009-400	2,-	317-009-600	15,-	338-090-200	27,-	962-454	20,-
20 mg	0,03	328-05	13,-	347-009-400	2,-	317-009-600	15,-	338-090-200	27,-	962-455	20,-
50 mg	0,04	328-06	13,-	347-009-400	2,-	317-009-600	15,-	338-090-200	27,-	962-456	20,-
100 mg	0,05	328-07	13,-	347-009-400	2,-	317-009-600	15,-	338-090-200	27,-	962-457	20,-
200 mg	0,06	328-08	13,-	347-009-400	2,-	317-009-600	15,-	338-090-200	27,-	962-458	20,-
500 mg	0,08	328-09	13,-	347-009-400	2,-	317-009-600	15,-	338-090-200	27,-	962-459	20,-

Class F1 - Individual weights, ECO shape or knob shape

Test weight material: stainless steel polished

Weight	Tol +/- mg	Individual weight, ECO shape		Individual weight, knob shape		Plastic box		Aluminium protected box		Wooden box		DAkkS certificate	
		KERN	€	KERN	€	KERN 	€	KERN 	€	KERN 	€	KERN	€
1 g	0,10	326-01	34,-	327-01	39,-	347-030-400	2,-	317-010-600	15,-	317-010-100	26,-	962-431	20,-
2 g	0,12	326-02	34,-	327-02	39,-	347-030-400	2,-	317-020-600	18,-	317-020-100	27,-	962-432	20,-
5 g	0,16	326-03	36,-	327-03	40,-	347-030-400	2,-	317-030-600	16,-	317-030-100	28,-	962-433	20,-
10 g	0,20	326-04	36,-	327-04	44,-	347-050-400	2,-	317-040-600	16,-	317-040-100	27,-	962-434	20,-
20 g	0,25	326-05	38,-	327-05	50,-	347-050-400	2,-	317-050-600	16,-	317-050-100	31,-	962-435	20,-
50 g	0,30	326-06	44,-	327-06	58,-	347-070-400	2,-	317-060-600	15,-	317-060-100	31,-	962-436	20,-
100 g	0,50	326-07	49,-	327-07	63,-	347-070-400	2,-	317-070-600	15,-	317-070-100	33,-	962-437	22,-
200 g	1,00	326-08	59,-	327-08	85,-	347-080-400	2,-	317-080-600	15,-	317-080-100	33,-	962-438	22,-
500 g	2,50	326-09	98,-	327-09	137,-	347-090-400	3,-	317-090-600	20,-	317-090-100	39,-	962-439	22,-
1 kg	5,00	326-11	130,-	327-11	173,-	347-110-400	3,80	317-110-600	28,-	317-110-100	63,-	962-441	22,-
2 kg	10	326-12	215,-	327-12	270,-	347-120-400	5,-	317-120-600	34,-	317-120-100	65,-	962-442	29,-
5 kg	25	326-13	290,-	327-13	405,-	347-130-400	11,-	317-130-600	56,-	317-130-100	99,-	962-443	29,-
10 kg	50	326-14	540,-	327-14	740,-	347-140-400	16,-	317-140-600	79,-	317-140-100	115,-	962-444	29,-
20 kg	100	-	-	327-15	1990,-	-	-	317-150-600	111,-	317-150-100	630,-	962-445	32,-
50 kg	250	-	-	327-16	4430,-	-	-	317-160-600	320,-	317-160-100	880,-	962-446	44,-

Class F1 - Block weights

Block weight material: stainless steel polished

Weight	Tol +/- mg	Block weight		Aluminium protected case		DAkkS certificate	
		KERN	€	KERN 	€	KERN	€
5 kg	25	326-36	1050,-	346-060-600	84,-	962-443	29,-
10 kg	50	326-37	1540,-	346-070-600	110,-	962-444	29,-
20 kg	100	326-38	2120,-	346-080-600	160,-	962-445	32,-
50 kg	250	326-39	5250,-	346-090-600	180,-	962-446	44,-

Class F1 - Test weights, stackable

Test weight material: stainless steel polished

Weight	Tol +/- mg	Test weight		Wooden case		DAkkS certificate	
		KERN	€	KERN 	€	KERN	€
10 kg	50	327-141	1400,-	337-141-100	340,-	962-444	29,-
20 kg	100	327-151	1800,-	337-151-100	370,-	962-445	32,-
50 kg	250	327-161	4220,-	337-161-100	570,-	962-446	44,-

Class F1 - Weight sets, ECO shape

Test weight material: Milligramm weights stainless steel, Individual weights: polished stainless steel

Weight sets	ECO shape in plastic case		ECO shape in aluminium protected case		ECO shape in wooden case		DAkkS certificate	
	KERN	€	KERN	€	KERN	€	KERN	€
1 mg - 500 mg	328-22	194,-	328-226	240,-	-	-	962-450	112,-
1 mg - 50 g	325-024	550,-	325-026	560,-	325-022	600,-	962-401	188,-
1 mg - 100 g	325-034	600,-	325-036	620,-	325-032	650,-	962-402	200,-
1 mg - 200 g	325-044	690,-	325-046	710,-	325-042	740,-	962-403	225,-
1 mg - 500 g	325-054	790,-	325-056	810,-	325-052	910,-	962-404	235,-
1 mg - 1 kg	325-064	1010,-	325-066	1020,-	325-062	1060,-	962-405	245,-
1 mg - 2 kg	325-074	1300,-	325-076	1320,-	325-072	1370,-	962-406	280,-
1 mg - 5 kg	325-084	1560,-	325-086	1620,-	325-082	1740,-	962-407	295,-
1 mg - 10 kg	-	-	325-096	2340,-	325-092	2320,-	962-408	320,-
1 g - 50 g	326-024	375,-	326-026	390,-	326-022	440,-	962-415	75,-
1 g - 100 g	326-034	420,-	326-036	440,-	326-032	490,-	962-416	87,-
1 g - 200 g	326-044	520,-	326-046	540,-	326-042	600,-	962-417	110,-
1 g - 500 g	326-054	610,-	326-056	630,-	326-052	750,-	962-418	122,-
1 g - 1 kg	326-064	830,-	326-066	850,-	326-062	900,-	962-419	134,-
1 g - 2 kg	326-074	1110,-	326-076	1140,-	326-072	1220,-	962-420	169,-
1 g - 5 kg	326-084	1390,-	326-086	1420,-	326-082	1600,-	962-421	187,-
1 g - 10 kg	-	-	326-096	2070,-	326-092	2160,-	962-422	205,-

Class F1 - Weight sets, knob shape

Test weight material: Milligramm weights stainless steel, Individual weights: polished stainless steel

Weight sets	Knob shape in plastic case		Knob shape in aluminium protected case		Knob shape in wooden case		DAkkS certificate	
	KERN	€	KERN	€	KERN	€	KERN	€
1 mg - 500 mg	328-22	194,-	328-226	240,-	-	-	962-450	112,-
1 mg - 50 g	323-024	610,-	323-026	630,-	323-02	640,-	962-401	188,-
1 mg - 100 g	323-034	670,-	323-036	690,-	323-03	700,-	962-402	200,-
1 mg - 200 g	323-044	820,-	323-046	840,-	323-04	880,-	962-403	225,-
1 mg - 500 g	323-054	970,-	323-056	990,-	323-05	1090,-	962-404	235,-
1 mg - 1 kg	323-064	1240,-	323-066	1240,-	323-06	1290,-	962-405	245,-
1 mg - 2 kg	323-074	1640,-	323-076	1670,-	323-07	1730,-	962-406	280,-
1 mg - 5 kg	323-084	2020,-	323-086	2060,-	323-08	2200,-	962-407	295,-
1 mg - 10 kg	-	-	323-096	2940,-	323-09	3040,-	962-408	320,-
1 g - 50 g	324-024	430,-	324-026	440,-	324-02	480,-	962-415	75,-
1 g - 100 g	324-034	490,-	324-036	510,-	324-03	560,-	962-416	87,-
1 g - 200 g	324-044	650,-	324-046	670,-	324-04	720,-	962-417	110,-
1 g - 500 g	324-054	780,-	324-056	810,-	324-05	930,-	962-418	122,-
1 g - 1 kg	324-064	1060,-	324-066	1070,-	324-06	1130,-	962-419	134,-
1 g - 2 kg	324-074	1460,-	324-076	1490,-	324-07	1570,-	962-420	169,-
1 g - 5 kg	324-084	1840,-	324-086	1940,-	324-08	2040,-	962-421	187,-
1 g - 10 kg	-	-	324-096	2790,-	324-09	2870,-	962-422	205,-

Test weights and boxes

Class F2



Milligram weights, flat polygonal sheet



Individual weights/Weight sets, knob shape



Block weight, stainless steel



Test weights (10 – 50 kg), finely turned stainless steel KERN 337-141 ff, optional: Wooden box



Plastic box, lined, for individual weights ≤ 200 g



Plastic box, lined, for individual weights ≥ 500 g



Aluminium protected box, lined, for individual weights



Wooden box, not lined for individual weights ≤ 500 g



Wooden box, not lined, for individual weights ≥ 1 kg



Milligram weight set in plastic box (338-22)



Milligram weight set in aluminium protected box, lined (338-226)



Plastic case, lined, for weight sets, knob shape





Aluminium protected case, lined, for weight sets, knob shape



Wooden case, for weight sets, knob shape



Class F2 - Milligram weights, flat polygonal sheet

Test weight material: stainless steel

Weight	Tol +/- mg	Milligram weight, flat polygonal sheet		Plastic box		Aluminium protected box		Wooden box		DAkkS certificate	
		KERN	€	KERN 	€	KERN 	€	KERN 	€	KERN	€
1 mg	0,06	338-01	9,70	347-009-400	2,-	317-009-600	15,-	338-090-200	27,-	962-451	20,-
2 mg	0,06	338-02	9,70	347-009-400	2,-	317-009-600	15,-	338-090-200	27,-	962-452	20,-
5 mg	0,06	338-03	9,70	347-009-400	2,-	317-009-600	15,-	338-090-200	27,-	962-453	20,-
10 mg	0,08	338-04	9,70	347-009-400	2,-	317-009-600	15,-	338-090-200	27,-	962-454	20,-
20 mg	0,10	338-05	9,70	347-009-400	2,-	317-009-600	15,-	338-090-200	27,-	962-455	20,-
50 mg	0,12	338-06	9,70	347-009-400	2,-	317-009-600	15,-	338-090-200	27,-	962-456	20,-
100 mg	0,16	338-07	9,70	347-009-400	2,-	317-009-600	15,-	338-090-200	27,-	962-457	20,-
200 mg	0,20	338-08	9,70	347-009-400	2,-	317-009-600	15,-	338-090-200	27,-	962-458	20,-
500 mg	0,25	338-09	9,70	347-009-400	2,-	317-009-600	15,-	338-090-200	27,-	962-459	20,-

Class F2 - Individual weights, knob shape

Test weight material: finely turned stainless steel

Weight	Tol +/- mg	Individual weight, knob shape		Plastic box		Aluminium protected box		Wooden box		DAkkS certificate	
		KERN	€	KERN 	€	KERN 	€	KERN 	€	KERN	€
1 g	0,3	337-01	23,-	347-030-400	2,-	317-010-600	15,-	337-010-200	21,-	962-431	20,-
2 g	0,4	337-02	24,-	347-030-400	2,-	317-020-600	18,-	337-020-200	17,-	962-432	20,-
5 g	0,5	337-03	26,-	347-030-400	2,-	317-030-600	16,-	337-030-200	18,-	962-433	20,-
10 g	0,6	337-04	28,-	347-050-400	2,-	317-040-600	16,-	337-040-200	18,-	962-434	20,-
20 g	0,8	337-05	29,-	347-050-400	2,-	317-050-600	16,-	337-050-200	18,-	962-435	20,-
50 g	1,0	337-06	32,-	347-070-400	2,-	317-060-600	15,-	337-060-200	20,-	962-436	20,-
100 g	1,6	337-07	36,-	347-070-400	2,-	317-070-600	15,-	337-070-200	24,-	962-437	22,-
200 g	3,0	337-08	48,-	347-080-400	2,-	317-080-600	15,-	337-080-200	25,-	962-438	22,-
500 g	8,0	337-09	71,-	347-090-400	3,-	317-090-600	20,-	337-090-200	26,-	962-439	22,-
1 kg	16	337-11	103,-	347-110-400	3,80	317-110-600	28,-	337-110-200	42,-	962-441	22,-
2 kg	30	337-12	163,-	347-120-400	5,-	317-120-600	34,-	337-120-200	47,-	962-442	29,-
5 kg	80	337-13	295,-	347-130-400	11,-	317-130-600	56,-	337-130-200	78,-	962-443	29,-
10 kg	160	337-14	570,-	347-140-400	16,-	317-140-600	79,-	337-140-200	82,-	962-444	29,-
20 kg	300	337-15	860,-	-	-	317-150-600	111,-	337-150-200	390,-	962-445	32,-
50 kg	800	337-16	1520,-	-	-	317-160-600	320,-	337-160-200	610,-	962-446	44,-

Class F2 - Test weights

Test weight material: finely turned stainless steel

Weight	Tol +/- mg	Test weight		Wooden box		DAkkS certificate	
		KERN	€	KERN 	€	KERN	€
10 kg	160	337-141	650,-	337-141-200	360,-	962-444	29,-
20 kg	300	337-151	790,-	337-151-200	390,-	962-445	32,-
50 kg	800	337-161	2130,-	337-161-200	610,-	962-446	44,-



Class F2 - Block weights

Block weight material: stainless steel glass bead blasted

Weight	Tol +/- mg	Block weight		Aluminium protected case		DAkkS certificate	
		KERN	€	KERN 	€	KERN	€
5 kg	80	336-36	610,-	346-060-600	84,-	962-443	29,-
10 kg	160	336-37	860,-	346-070-600	110,-	962-444	29,-
20 kg	300	336-38	1180,-	346-080-600	160,-	962-445	32,-
50 kg	800	336-39	3080,-	346-090-600	180,-	962-446	44,-

Class F2 - Weight sets, knob shape

Test weight material: Milligramm weights stainless steel, individual weights finely turned stainless steel

Weight	Knob shape in plastic case		Knob shape in aluminium protected case		Knob shape in wooden case		DAkkS certificate	
	KERN 	€	KERN 	€	KERN 	€	KERN	€
1 mg - 500 mg	338-22	151,-	338-226	200,-	-	-	962-450	112,-
1 mg - 50 g	333-024	390,-	333-026	410,-	333-02	410,-	962-401	188,-
1 mg - 100 g	333-034	435,-	333-036	450,-	333-03	455,-	962-402	200,-
1 mg - 200 g	333-044	510,-	333-046	520,-	333-04	520,-	962-403	225,-
1 mg - 500 g	333-054	580,-	333-056	600,-	333-05	610,-	962-404	235,-
1 mg - 1 kg	333-064	730,-	333-066	750,-	333-06	760,-	962-405	245,-
1 mg - 2 kg	333-074	1030,-	333-076	1050,-	333-07	1060,-	962-406	280,-
1 mg - 5 kg	333-084	1380,-	333-086	1420,-	333-08	1420,-	962-407	295,-
1 mg - 10 kg	-	-	333-096	2060,-	333-09	2080,-	962-408	320,-
1 g - 50 g	334-024	255,-	334-026	275,-	334-02	270,-	962-415	75,-
1 g - 100 g	334-034	300,-	334-036	315,-	334-03	320,-	962-416	87,-
1 g - 200 g	334-044	395,-	334-046	415,-	334-04	415,-	962-417	110,-
1 g - 500 g	334-054	470,-	334-056	490,-	334-05	490,-	962-418	122,-
1 g - 1 kg	334-064	610,-	334-066	620,-	334-06	630,-	962-419	134,-
1 g - 2 kg	334-074	890,-	334-076	940,-	334-07	940,-	962-420	169,-
1 g - 5 kg	334-084	1210,-	334-086	1300,-	334-08	1290,-	962-421	187,-
1 g - 10 kg	-	-	334-096	1940,-	334-09	1950,-	962-422	205,-

Test weights and boxes

Class M1



Milligram weights, flat polygonal sheet



Individual weights/weight sets, knob shape, finely turned stainless steel



Hook weights, finely turned stainless steel



Slotted weights, finely turned stainless steel



Plastic box, for individual weights ≤ 200 g, for hook weights and slotted weights ≤ 50 g



Plastic box, lined, for individual weights ≥ 500 g, for hook weights and slotted weights ≥ 100 g



Aluminium protected box, lined, for individual weights



Wooden box, not lined, for individual weights ≤ 500 g



Wooden box, not lined, for individual weights ≥ 1 kg



Milligram weight set in plastic box (348-22)



Milligram weight set in aluminium protected box, lined (348-226)



Plastic case, lined, for weight sets, knob shape, finely turned stainless steel



Aluminium protected case, lined, for weight sets, knob shape, finely turned stainless steel



Wooden case, for weight sets, knob shape, finely turned stainless steel



Test weights (10 - 50 kg), finely turned stainless steel KERN 347-141 ff, optional: Wooden box

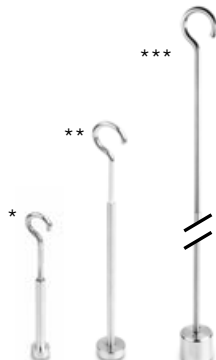

Beam bars, for fixing slotted weights, aluminium or finely turned stainless steel



* | ** | *** see page 201



Block weights, lacquered cast iron/stainless steel glass bead blasted, optional: Aluminium protected case, lined



Class M1 • Milligram weights, flat polygonal sheet

Test weight material: stainless steel

Weight	Tol +/- mg	Milligram weight, flat polygonal sheet		Plastic box		Aluminium protected box		Wooden box		DAkkS certificate	
		KERN	€	KERN 	€	KERN 	€	KERN 	€	KERN	€
1 mg	0,20	348-01	5,10	347-009-400	2,-	317-009-600	15,-	338-090-200	27,-	962-651	16,-
2 mg	0,20	348-02	5,10	347-009-400	2,-	317-009-600	15,-	338-090-200	27,-	962-652	16,-
5 mg	0,20	348-03	5,10	347-009-400	2,-	317-009-600	15,-	338-090-200	27,-	962-653	16,-
10 mg	0,25	348-04	5,10	347-009-400	2,-	317-009-600	15,-	338-090-200	27,-	962-654	16,-
20 mg	0,30	348-05	5,10	347-009-400	2,-	317-009-600	15,-	338-090-200	27,-	962-655	16,-
50 mg	0,40	348-06	5,10	347-009-400	2,-	317-009-600	15,-	338-090-200	27,-	962-656	16,-
100 mg	0,50	348-07	5,10	347-009-400	2,-	317-009-600	15,-	338-090-200	27,-	962-657	16,-
200 mg	0,60	348-08	5,10	347-009-400	2,-	317-009-600	15,-	338-090-200	27,-	962-658	16,-
500 mg	0,80	348-09	5,10	347-009-400	2,-	317-009-600	15,-	338-090-200	27,-	962-659	16,-

Class M1 • Individual weights, knob shape

Test weights material: stainless steel

Weight	Tol +/- mg	Individual weight		Plastic box		Aluminium protected box		Wooden box		DAkkS certificate	
		KERN	€	KERN 	€	KERN 	€	KERN 	€	KERN	€
1 g	1,0	347-01	8,40	347-030-400	2,-	317-010-600	15,-	337-010-200	21,-	962-631	16,-
2 g	1,2	347-02	8,80	347-030-400	2,-	317-020-600	18,-	337-020-200	17,-	962-632	16,-
5 g	1,6	347-03	8,90	347-030-400	2,-	317-030-600	16,-	337-030-200	18,-	962-633	16,-
10 g	2,0	347-04	9,60	347-050-400	2,-	317-040-600	16,-	337-040-200	18,-	962-634	16,-
20 g	2,5	347-05	14,-	347-050-400	2,-	317-050-600	16,-	337-050-200	18,-	962-635	16,-
50 g	3,0	347-06	16,-	347-070-400	2,-	317-060-600	15,-	337-060-200	20,-	962-636	16,-
100 g	5,0	347-07	20,-	347-070-400	2,-	317-070-600	15,-	337-070-200	24,-	962-637	18,-
200 g	10	347-08	25,-	347-080-400	2,-	317-080-600	15,-	337-080-200	25,-	962-638	18,-
500 g	25	347-09	41,-	347-090-400	3,-	317-090-600	20,-	337-090-200	26,-	962-639	18,-
1 kg	50	347-11	64,-	347-110-400	3,80	317-110-600	28,-	337-110-200	42,-	962-641	18,-
2 kg	100	347-12	120,-	347-120-400	5,-	317-120-600	34,-	337-120-200	47,-	962-642	19,-
5 kg	250	347-13	270,-	347-130-400	11,-	317-130-600	56,-	337-130-200	78,-	962-643	19,-
10 kg	500	347-14	520,-	347-140-400	16,-	317-140-600	79,-	337-140-200	82,-	962-644	19,-

Class M1 • Block weights

Block weight material: lacquered cast iron, surface and edges machined or unmachined (ECO)

Weight	Tol +/- g	Block weight		ECO Block weight		Aluminium protected case		DAkkS certificate	
		KERN	€	KERN	€	KERN 	€	KERN	€
5 kg	0,25	346-86	76,-	346-76	61,-	346-060-600	84,-	962-643	19,-
10 kg	0,50	346-87	132,-	346-77	102,-	346-070-600	110,-	962-644	19,-
20 kg	1,00	346-88	245,-	346-78	188,-	346-080-600	160,-	962-645	24,-
50 kg	2,50	346-89	590,-	346-79	455,-	346-090-600	180,-	962-646	27,-

Class M1 • Block weights

Block weight material: stainless steel glass bead blasted

Weight	Tol +/- g	Block weight		Aluminium protected case		DAkkS certificate	
		KERN	€	KERN 	€	KERN	€
5 kg	0,25	346-06	410,-	346-060-600	84,-	962-643	19,-
10 kg	0,50	346-07	550,-	346-070-600	110,-	962-644	19,-
20 kg	1,00	346-08	740,-	346-080-600	160,-	962-645	24,-
50 kg	2,50	346-09	1970,-	346-090-600	180,-	962-646	27,-

Class M1 · Test weights, stackable

Test weight material: finely turned stainless steel

Weight	Tol +/- g	Test weight		Wooden box		DAkkS certificate	
		KERN	€	KERN		€	KERN
10 kg	0,5	347-141	650,-	337-141-200	360,-	962-644	19,-
20 kg	1,0	347-151	800,-	337-151-200	390,-	962-645	24,-
50 kg	2,5	347-161	2 130,-	337-161-200	6 10,-	962-646	27,-

Class M1 · Heavy duty weights, stackable

Heavy duty weight material: lacquered cast iron

Designed to be lifted with forklift trucks or cranes, delivery time is approx. 6–8 weeks

Dimensions: see internet on www.kern-sohn.com

Weight	Tol +/- g	Heavy duty weight		DAkkS certificate	
		KERN	€	KERN	€
100 kg	5	346-81	2 420,-	962-691	70,-
200 kg	10	346-82	3 520,-	962-692	70,-
500 kg	25	346-83	6 290,-	962-693	70,-
1000 kg	50	346-84	9 870,-	962-694	153,-
2000 kg	100	346-85	18 060,-	962-695	280,-





Note

We also offer a large range of heavy-duty weights in other materials, (e.g. stainless steel) and in other forms (e.g. discs) or individual weight containers, please ask for details.

Class M1 · Weight sets, knob shape

Test weight material: Milligramm weights stainless steel, individual weights finely turned stainless steel

Weight	Knob shape, in plastic case		Knob shape, in aluminium protected case		Knob shape, in wooden case		DAkkS certificate	
	KERN	 €	KERN	 €	KERN	 €	KERN	€
1 mg - 500 mg	348-22	94,-	348-226	159,-	-	-	962-650	70,-
1 mg - 50 g	343-024	265,-	343-026	240,-	343-02	240,-	962-601	119,-
1 mg - 100 g	343-034	280,-	343-036	260,-	343-03	270,-	962-602	125,-
1 mg - 200 g	343-044	325,-	343-046	305,-	343-04	315,-	962-603	141,-
1 mg - 500 g	343-054	360,-	343-056	350,-	343-05	360,-	962-604	147,-
1 mg - 1 kg	343-064	550,-	343-066	450,-	343-06	520,-	962-605	154,-
1 mg - 2 kg	343-074	740,-	343-076	690,-	343-07	730,-	962-606	170,-
1 mg - 5 kg	343-084	990,-	343-086	980,-	343-08	1040,-	962-607	180,-
1 mg - 10 kg	-	-	343-096	1500,-	343-09	1560,-	962-608	188,-
1 g - 50 g	344-024	178,-	344-026	171,-	344-02	143,-	962-615	47,-
1 g - 100 g	344-034	197,-	344-036	191,-	344-03	176,-	962-616	55,-
1 g - 200 g	344-044	240,-	344-046	235,-	344-04	225,-	962-617	68,-
1 g - 500 g	344-054	280,-	344-056	275,-	344-05	275,-	962-618	76,-
1 g - 1 kg	344-064	465,-	344-066	380,-	344-06	415,-	962-619	83,-
1 g - 2 kg	344-074	650,-	344-076	610,-	344-07	630,-	962-620	100,-
1 g - 5 kg	344-084	900,-	344-086	920,-	344-08	930,-	962-621	108,-
1 g - 10 kg	-	-	344-096	1440,-	344-09	1450,-	962-622	116,-

Class M1 · Hook weights

Hook weight material: finely turned stainless steel

Weight	Tol +/- mg	Hook weight		Plastic box, lined		DAkkS certificate	
		KERN	€	KERN	€	KERN	€
1 g	1,0	347-016	24,-	347-030-400	2,-	962-631	16,-
2 g	1,2	347-026	24,-	347-030-400	2,-	962-632	16,-
5 g	1,6	347-036	24,-	347-030-400	2,-	962-633	16,-
10 g	2,0	347-046	25,-	347-050-400	2,-	962-634	16,-
20 g	2,5	347-056	27,-	347-050-400	2,-	962-635	16,-
50 g	3,0	347-066	33,-	347-070-400	2,-	962-636	16,-
100 g	5,0	347-076	35,-	347-090-400	3,-	962-637	18,-
200 g	10,0	347-086	41,-	347-090-400	3,-	962-638	18,-
500 g	25,0	347-096	78,-	347-110-400	3,80	962-639	18,-
1 kg	50,0	347-116	107,-	347-120-400	5,-	962-641	18,-
2 kg	100,0	347-126	176,-	347-130-400	11,-	962-642	19,-
5 kg	250,0	347-136	345,-	347-140-400	16,-	962-643	19,-
10 kg	500,0	347-146	570,-	-	-	962-644	19,-

Class M1 · Slotted weights

Slotted weight material: finely turned stainless steel

Weight	Tol +/- mg	Slotted weight		Plastic box, lined		DAkkS certificate	
		KERN	€	KERN	€	KERN	€
1 g	1,0	347-015	24,-	347-030-400	2,-	962-631	16,-
2 g	1,2	347-025	22,-	347-030-400	2,-	962-632	16,-
5 g	1,6	347-035	25,-	347-030-400	2,-	962-633	16,-
10 g	2,0	347-045	26,-	347-030-400	2,-	962-634	16,-
20 g	2,5	347-055	27,-	347-080-400	2,-	962-635	16,-
50 g	3,0	347-065	30,-	347-080-400	2,-	962-636	16,-
100 g	5,0	347-075	33,-	347-090-400	3,-	962-637	18,-
200 g	10	347-085	45,-	347-090-400	3,-	962-638	18,-
500 g	25	347-095	70,-	347-110-400	3,80	962-639	18,-
1 kg	50	347-115	126,-	347-130-400	11,-	962-641	18,-
2 kg	100	347-125	187,-	347-130-400	11,-	962-642	19,-
5 kg	250	347-135	325,-	347-140-400	16,-	962-643	19,-
10 kg	500	347-145	590,-	347-140-400	16,-	962-644	19,-

Class M1 · Beam bars, for fixing slotted weights

Beam bars material: 10 g: aluminium, 100 g-1 kg: finely turned stainless steel

Own weight beam bar	Maximum total load ⁽¹⁾	Largest slotted weight possible	Material	Length	Beam bar		DAkkS certificate	
					KERN	€	KERN	€
10 g	200 g	100 g	Aluminium	117,5	347-445-100*	35,-	962-634	16,-
100 g	2 kg	1 kg	Stainless steel	238	347-075-100**	58,-	962-637	18,-
500 g	20 kg	10 kg	Stainless steel	639	347-095-100***	92,-	962-639	18,-
1 kg	40 kg	10 kg	Stainless steel	1020	347-115-100***	148,-	962-641	18,-

⁽¹⁾ is exclusive of the own weight of the beam bar, e.g. the maximum possible total weight is calculated from

“Maximum total load” + “own weight beam bar”;

* | ** | *** see page 198

Newton weights (N)

All hook and slotted weights as well as beam bars are available with N adjustment according to M1 tolerances, additional price € 8,-/pc. We need to know the location of use and postal code.

DAkkS calibration certificate for N weights: identical to DAkkS prices for individual weights M1, additional price € 8,-

Test weights and boxes

Classes M2 · M3



Individual weights/Weight sets,
knob shape, stainless steel



Individual weights/Weight sets,
knob shape, lacquered cast iron



Block weights,
lacquered cast iron



Plastic box, lined,
for individual weights



Aluminium protected box,
lined, for individual weights



Wooden box, not lined, for
individual weights ≤ 500 g,
not appropriate for
cast iron weights



Wooden box, not lined, for
individual weights ≥ 1 kg,
not appropriate for
cast iron weights



Aluminium protected case,
lined, for block weights



Aluminium protected case, lined, for weight
sets knob shape, finely turned stainless steel,
not appropriate for cast iron weights





Wooden case, for weight sets, knob shape,
finely turned stainless steel



Wooden block, for weight sets, knob shape,
lacquered cast iron

Class M2 · Individual weights, knob shape

Test weight material: finely turned stainless steel

Weight	Tol +/- mg	Individual weight, knob shape		Plastic box		Aluminium protected box		Wooden box		DAkkS certificate	
		KERN	€	KERN 	€	KERN 	€	KERN 	€	KERN	€
1 g	3	357-01	8,40	347-030-400	2,-	317-010-600	15,-	337-010-200	21,-	962-631	16,-
2 g	4	357-02	8,70	347-030-400	2,-	317-020-600	18,-	337-020-200	17,-	962-632	16,-
5 g	5	357-03	8,90	347-030-400	2,-	317-030-600	16,-	337-030-200	18,-	962-633	16,-
10 g	6	357-04	9,60	347-050-400	2,-	317-040-600	16,-	337-040-200	18,-	962-634	16,-
20 g	8	357-05	14,-	347-050-400	2,-	317-050-600	16,-	337-050-200	18,-	962-635	16,-
50 g	10	357-06	16,-	347-070-400	2,-	317-060-600	15,-	337-060-200	20,-	962-636	16,-
100 g	16	357-07	20,-	347-070-400	2,-	317-070-600	15,-	337-070-200	24,-	962-637	18,-
200 g	30	357-08	24,-	347-080-400	2,-	317-080-600	15,-	337-080-200	25,-	962-638	18,-
500 g	80	357-09	41,-	347-090-400	3,-	317-090-600	20,-	337-090-200	26,-	962-639	18,-
1 kg	160	357-11	64,-	347-110-400	3,80	317-110-600	28,-	337-110-200	42,-	962-641	18,-
2 kg	300	357-12	120,-	347-120-400	5,-	317-120-600	34,-	337-120-200	47,-	962-642	19,-
5 kg	800	357-13	270,-	347-130-400	11,-	317-130-600	56,-	337-130-200	78,-	962-643	19,-
10 kg	1600	357-14	520,-	347-140-400	16,-	317-140-600	79,-	337-140-200	82,-	962-644	19,-



Class M2 · Block weights

Block weight material: lacquered cast iron, surface and edges machined or unmachined (ECO)

Weight	Tol +/- g	Block weight		ECO block weight		Aluminium protected box		DAkkS certificate	
		KERN	€	KERN	€	KERN 	€	KERN	€
5 kg	0,8	356-86	66,-	356-76	61,-	346-060-600	84,-	962-643	19,-
10 kg	1,6	356-87	132,-	356-77	102,-	346-070-600	110,-	962-644	19,-
20 kg	3,0	356-88	245,-	356-78	188,-	346-080-600	160,-	962-645	24,-
50 kg	8,0	356-89	590,-	356-79	455,-	346-090-600	180,-	962-646	27,-

Class M2 · Weight sets, knob shape

Test weight material: finely turned stainless steel

Weight	Knob shape, in aluminium protected case		Knob shape, in wooden case		DAkkS certificate	
	KERN 	€	KERN 	€	KERN	€
1 g - 50 g	354-026	137,-	354-02	108,-	962-615	47,-
1 g - 100 g	354-036	152,-	354-03	138,-	962-616	55,-
1 g - 200 g	354-046	192,-	354-04	179,-	962-617	68,-
1 g - 500 g	354-056	235,-	354-05	240,-	962-618	76,-
1 g - 1 kg	354-066	340,-	354-06	380,-	962-619	83,-
1 g - 2 kg	354-076	580,-	354-07	600,-	962-620	100,-
1 g - 5 kg	354-086	920,-	354-08	920,-	962-621	108,-
1 g - 10 kg	354-096	1530,-	354-09	1530,-	962-622	116,-

Class M3 · Individual weights, knob shape

Test weight material: finely turned stainless steel

Weight	Tol +/- mg	Individual weight, knob shape		Plastic box		Aluminium protected box		Wooden box		DAkkS certificate	
		KERN	€	KERN	€	KERN	€	KERN	€	KERN	€
1 g	10	367-01	8,40	347-030-400	2,-	317-010-600	15,-	337-010-200	21,-	962-631	16,-
2 g	12	367-02	8,50	347-030-400	2,-	317-020-600	18,-	337-020-200	17,-	962-632	16,-
5 g	16	367-03	8,60	347-030-400	2,-	317-030-600	16,-	337-030-200	18,-	962-633	16,-
10 g	20	367-04	9,10	347-050-400	2,-	317-040-600	16,-	337-040-200	18,-	962-634	16,-
20 g	25	367-05	12,-	347-050-400	2,-	317-050-600	16,-	337-050-200	18,-	962-635	16,-
50 g	30	367-06	14,-	347-070-400	2,-	317-060-600	15,-	337-060-200	20,-	962-636	16,-
100 g	50	367-07	18,-	347-070-400	2,-	317-070-600	15,-	337-070-200	24,-	962-637	18,-
200 g	100	367-08	23,-	347-080-400	2,-	317-080-600	15,-	337-080-200	25,-	962-638	18,-
500 g	250	367-09	39,-	347-090-400	3,-	317-090-600	20,-	337-090-200	26,-	962-639	18,-
1 kg	500	367-11	62,-	347-110-400	3,80	317-110-600	28,-	337-110-200	42,-	962-641	18,-
2 kg	1000	367-12	119,-	347-120-400	5,-	317-120-600	34,-	337-120-200	47,-	962-642	19,-

Class M3 · Individual weights, knob and cylindrical shape

Test weight material: lacquered cast iron

Weight	Tol +/- g	Individual weight, knob and cylindrical shape		DAkkS certificate	
		KERN	€	KERN	€
100 g*	0,05	366-91	25,-	962-637	18,-
200 g*	0,10	366-92	29,-	962-638	18,-
500 g**	0,25	366-93	40,-	962-639	18,-
1 kg**	0,50	366-94	47,-	962-641	18,-
2 kg**	1,0	366-95	80,-	962-642	19,-
5 kg**	2,5	366-96	145,-	962-643	19,-
10 kg**	5,0	366-97	265,-	962-644	19,-



Class M3 · Block weights

Block weight material: lacquered cast iron, surface and edges machined or unmachined (ECO)

Weight	Tol +/- g	Block weight		ECO block weight		Aluminium protected box		DAkkS certificate	
		KERN	€	KERN	€	KERN	€	KERN	€
5 kg	2,5	366-86	66,-	366-76	61,-	346-060-600	84,-	962-643	19,-
10 kg	5,0	366-87	110,-	366-77	102,-	346-070-600	110,-	962-644	19,-
20 kg	10	366-88	196,-	366-78	188,-	346-080-600	160,-	962-645	24,-
50 kg	25	366-89	490,-	366-79	455,-	346-090-600	180,-	962-646	27,-

Class M3 · Weight sets, knob and cylindrical shape

Test weight material: ≤ 50 g stainless steel, ≥ 100 g lacquered cast iron

Weight	Knob and cylindrical shape, in wooden block		DAkkS certificate	
	KERN	€	KERN	€
1 g - 1 kg	362-96	250,-	962-619	83,-
1 g - 2 kg	362-97	400,-	962-620	100,-
1 g - 5 kg	362-98	510,-	962-621	108,-
1 g - 10 kg	362-99	720,-	962-622	116,-



Individual weights ≤ 50 g

Individual weights 100 g and 200 g

Individual weights ≥ 500 g

Tweezers, weight grips, gloves, dusting brush



Tweezers

to be able to safely grip small test weights

For class	For weight	Length	Version	KERN	€
E1 - M3	1 mg - 200 g	105 mm	1 Stainless steel with silicone-coated tips	315-243	15,-
E1 - M3	500 g - 2 kg	250 mm	1 Stainless steel with silicone-coated tips	315-245	60,-
E1 - M3	≤ 5 g	130 mm	2 Stainless steel, curved, high-quality plastic tips	315-246	23,-
E1 - M3	≤ 5 g	136 mm	3 Stainless steel, straight, high quality plastic tips	315-247	23,-
E1 - M3	≤ 200 g	225 mm	4 Stainless steel, straight, high-quality plastic tips, with a special shape for gripping weights of various shapes and sizes	315-248	38,-
F2 - M3	1 mg - 200 g	100 mm	5 Stainless steel	335-240	17,-
E1 - M3	1 mg - 200 g	100 mm	6 Plastic	315-242	8,-

Weight grip

plastic coated

For class	For knob shaped weights	KERN	€
E1 - M3	2 kg	315-273	35,-
E1 - M3	5 kg	315-274	40,-
E1 - M3	10 kg	315-275	45,-
E1 - M3	20 kg	315-276	68,-



! not appropriate for cast iron weights



Gloves

Cotton, 1 pair. Help to protect the test weights when being used daily, from grease from fingers, damp etc.

Suitable for test weights up to 2 kg.

KERN	€
317-280	2,50



Gloves

Leather/cotton, 1 pair. Help to protect the test weights when being used daily, from grease from fingers, damp etc.

Ideal for test weights from 2 kg.

KERN	€
317-290	6,90



Premium gloves

Nylon, 1 pair. Particularly elastic, one size fits all, with special fingertip coating to ensure a safe grip. Helps to protect the test weights in everyday use from grease from fingers, damp etc.

Ideal for all test weights.

KERN	€
317-281	9,-



Dusting brush

to clean the weights

KERN	€
318-270	7,20



Bellows

for cleaning weights

KERN	€
318-271	9,60



Microfibre cloth

for cleaning weights

KERN	€
318-272	6,90

Boxes for individual weights



For weights ≤ 500 g, OIML class E1 – F1
For weights ≥ 1 kg, OIML class E1 – F1

Case material: Wood, lined, suitable for single weights, KERN No. 307, 316, 317, 326, 327



For weights ≤ 500 g, OIML class F2 – M3
For weights ≥ 1 kg, OIML class F2 – M3

Case material: Wood, not lined, suitable for single weights, KERN No. 337, 347, 357, 367
■ not suitable for cast iron weights



For test weights ≥ 10 kg, OIML class F1 – M1

Case material: Wood, lined/not lined, suitable for single weights, KERN No. 327, 337, 347
■ not suitable for cast iron weights

Wooden box, lined

for single weights E1 – F1

For weights	KERN	€
-	-	-
1 g	317-010-100	26,-
2 g	317-020-100	27,-
5 g	317-030-100	28,-
10 g	317-040-100	27,-
20 g	317-050-100	31,-
50 g	317-060-100	31,-
100 g	317-070-100	33,-
200 g	317-080-100	33,-
500 g	317-090-100	39,-
1 kg	317-110-100	63,-
2 kg	317-120-100	65,-
5 kg	317-130-100	99,-
10 kg	317-140-100	115,-
20 kg	317-150-100	630,-
50 kg	317-160-100	880,-

Wooden box, not lined

for single weights F2 – M3

For weights	KERN	€
mg	338-090-200	27,-
1 g	337-010-200	21,-
2 g	337-020-200	17,-
5 g	337-030-200	18,-
10 g	337-040-200	18,-
20 g	337-050-200	18,-
50 g	337-060-200	20,-
100 g	337-070-200	24,-
200 g	337-080-200	25,-
500 g	337-090-200	26,-
1 kg	337-110-200	42,-
2 kg	337-120-200	47,-
5 kg	337-130-200	78,-
10 kg	337-140-200	82,-
20 kg	337-150-200	390,-
50 kg	337-160-200	610,-

Wooden box, not lined

for test weights F1 – M1

For weights	KERN	€
10 kg	337-141-200	360,-
20 kg	337-151-200	390,-
50 kg	337-161-200	610,-

Wooden box, lined

for test weights F1 – M1

For weights	KERN	€
10 kg	337-141-100	340,-
20 kg	337-151-100	370,-
50 kg	337-161-100	570,-



For weights ≤ 5 kg, OIML class E1 – M3

Case material: Aluminium protected, lined, suitable for mg and single weights, KERN No. 307, 308, 316, 317, 318, 326, 327, 328, 337, 338, 347, 348, 357, 367
■ not suitable for cast iron weights

Aluminium protected box, lined

for individual weights, knob and compact shape, class E1 – M3

For weights	KERN	€
mg	317-009-600	15,-
1 g	317-010-600	15,-
2 g	317-020-600	18,-
5 g	317-030-600	16,-
10 g	317-040-600	16,-
20 g	317-050-600	16,-
50 g	317-060-600	15,-
100 g	317-070-600	15,-
200 g	317-080-600	15,-
500 g	317-090-600	20,-
1 kg	317-110-600	28,-
2 kg	317-120-600	34,-
5 kg	317-130-600	56,-



For weights ≤ 10 kg, OIML class E1 – M3

Case material: Aluminium protected, lined, suitable for single weights, KERN No. 307, 316, 317, 326, 327, 337, 347, 357, 367
■ not suitable for cast iron weights

Aluminium protected box, lined

for individual weights, knob and compact shape, class E1 – M3

For weights	KERN	€
10 kg	317-140-600	79,-
20 kg	317-150-600	111,-
50 kg	317-160-600	320,-



For block weight ≥ 5 kg, OIML class F1 – M3

Case material: Aluminium protected, lined, suitable for block weights, KERN No. 326, 336, 346, 356, 366

Aluminium protected case, lined

for individual weights F1 – M3

For weights	KERN	€
5 kg	346-060-600	84,-
10 kg	346-070-600	110,-
20 kg	346-080-600	160,-
50 kg	346-090-600	180,-

Carrying cases/boxes for individual weight sets

Individual weight sets:

You can create your own "tailor-made" individual weight sets yourself. KERN will customise your own personal wooden box/plastic carrying case. The largest individual weight which will fit is given in the table.

Sample order:

Your individual weight set (class F1):
1 × 50 g, 2 × 100 g, 1 × 500 g, 2 × 1 kg, 1 × 2 kg.

The correct individual box is **KERN No. 313-080-400** (plastic) or **KERN No. 315-070-100** (wood, lined)



Plastic case

for individual weight sets classes E1 – M3, not appropriate for cast iron weights

Largest possible weight	KERN		€
≤ 500 g	313-050-400		166,-
≤ 5 kg	313-080-400		320,-

Wooden case

lined, for individual weight sets classes E1 – F1
* with side handles

Largest possible weight	KERN		€
≤ 200 g	315-040-100		245,-
≤ 1 kg	315-060-100		345,-
≤ 2 kg	315-070-100		425,-
≤ 5 kg*	315-080-100		540,-
≤ 10 kg*	315-090-100		560,-

Wooden case not lined, for individual weight set classes F2 – M3, not appropriate for cast iron weights
* with side handles

Largest possible weight	KERN		€
≤ 200 g	335-040-200		141,-
≤ 500 g	335-050-200		141,-
≤ 1 kg	335-060-200		200,-
≤ 2 kg	335-070-200		225,-
≤ 5 kg*	335-080-200		315,-
≤ 10 kg*	335-090-200		330,-

Carrying cases for standard weight sets



Fig. shows
313-010-600

Aluminium protected case for safe storage and transportation under harsh industrial conditions.

Plastic case for weight sets

with standard denomination classes E1 – M3, not appropriate for cast iron weights

Largest possible weight	KERN		€
≤ 500 g	313-052-400		100,-
≤ 5 kg	313-082-400		205,-

Aluminium protected case

for weight sets with standard denomination classes E1 – M2
*1 front handle; **2 side handles; ***no handle

For weights	For class	KERN		€
1 mg - 500 mg	E1 - M1	313-010-600*		97,-
1 mg - 50 g	E1 - M1	313-020-600*		99,-
1 mg - 100 g	E1 - M1	313-030-600*		108,-
1 mg - 200 g	E1 - M1	313-040-600*		115,-
1 mg - 500 g	E1 - M1	313-050-600*		139,-
1 mg - 1 kg	E1 - M1	313-060-600*		169,-
1 mg - 2 kg	E1 - M1	313-070-600**		199,-
1 mg - 5 kg	E1 - M1	313-080-600***		265,-
1 mg - 10 kg	E1 - M1	313-090-600***		345,-
1 g - 50 g	E1 - M2	314-020-600*		94,-
1 g - 100 g	E1 - M2	314-030-600*		103,-
1 g - 200 g	E1 - M2	314-040-600*		110,-
1 g - 500 g	E1 - M2	314-050-600*		134,-
1 g - 1 kg	E1 - M2	314-060-600*		164,-
1 g - 2 kg	E1 - M2	314-070-600*		194,-
1 g - 5 kg	E1 - M2	314-080-600***		260,-
1 g - 10 kg	E1 - M2	314-090-600***		345,-

Weight containers for rectangular weights or other test weights, stainless steel glass bead blasted, adjusted to OIML class M1

Preconfigured weight containers for testing high-load floor scales, pallet scales, pallet truck scales, crane scales, etc. This can also be used for storing the weights. This means the weight container and the weights can be placed on the balance in one go, saving you time and money. The weight container is adjusted to OIML accuracy class M1. Other OIML accuracy classes are also available, please ask.

Weight of the weight container, OIML class M1	Tol +/- g	Possible equipment, rectangular weights, OIML class M1	Maximum total weight (weight container incl. weights)	Price (weight container excluding weights)	
				KERN	€
20 kg	1,0	5 × 20 kg	120 kg	346-022-005	1690,-
40 kg	1,5	8 × 20 kg	200 kg	346-042-008	2180,-
50 kg	2,5	10 × 20 kg	250 kg	346-052-010	2180,-
50 kg	2,5	4 × 50 kg	250 kg	346-055-004	2180,-
50 kg	2,5	9 × 50 kg	500 kg	346-055-009	2180,-
60 kg	3,0	8 × 50 kg and 2 × 20 kg	500 kg	346-065-009	2370,-



Weight of the weight container, OIML class M1	Tol +/- g	Possible equipment, test weights, OIML class M1	Maximum total weight (weight container incl. weights)	Price (weight container excluding weights)	
				KERN	€
20 kg	1,0	max. 10 × 10 kg or 5 × 20 kg	120 kg	347-022-005	1690,-
40 kg	2,0	max. 16 × 10 kg or 8 × 20 kg	200 kg	347-042-008	1990,-
50 kg	2,5	max. 20 × 10 kg or 10 × 20 kg	250 kg	347-052-010	2180,-
60 kg	3,0	max. 22 × 20 kg	500 kg	347-062-022	2370,-



Individual weight containers for rectangular weights or other test weights, calibrated to OIML class M1

Individual weight carriers for testing high capacity floor scales, pallet scales, pallet truck scales, crane scales, etc. This can also be used for storing the weights. This means the weight container and the weights can be placed on the scale in one go, saving time and money.

The weight container can be calibrated to OIML accuracy classes M1 – M3. On request, KERN will make you a “tailor-made” weight carrier to your specifications.

Example:

3 block weights each 50 kg, class M1 = 150 kg
 1 weight container each 50 kg, class M1 = 50 kg
 Total = 200 kg

Weight of the weight container, OIML class M1	Price	
	KERN	€
Individual weight container for rectangular weights	346-000-000	Price on request
Individual weight container for test weights	347-000-000	Price on request



Example illustration

ASSORTMENT RANGE LEADER AND HIDDEN CHAMPION IN THE REGION: KERN WEIGHING & MEASURING TECHNOLOGY

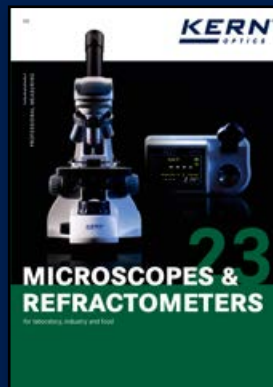

KERN – the king of broad product ranges

Reliable, easy, durable products from the world of weighing and measuring technology, innovative software and the competent test service from KERN and SAUTER will win you over.

The best thing to do is to request our special catalogues straight-away – free of charge, of course!

There is also plenty for you to discover online: latest offers, new models, sale items and interesting news ...

You can also place orders by going online www.kern-sohn.com



PROFESSIONAL MEASURING

18

DAKKS CALIBRATION SERVICE/ VERIFICATION SERVICE

The DAkkS (German accreditation body)

The DAkkS is the national accreditation body of the Federal Republic of Germany. According to Regulation (EC) No. 765/2008 and the Accreditation Body Act (AkkStelleG), the DAkkS acts in the public interest as the sole service provider for accreditation in Germany.

In order to be able to fulfil its sovereign accreditation tasks, the DAkkS was entrusted by the Federal Government. As an entrusted body, the DAkkS is subject to federal supervision.

Only an accredited calibration laboratory can issue a DAkkS calibration certificate. This defines not only the measuring method as well as the measuring result, but also gives information on tracing the test medium to national standards and the relevant uncertainty of measurement.

-
- > **You are certified to ...**
ISO 9001, QS 9000, GLP, GMP, TS16949
 - > **You need ...**
to control your measuring equipment
 - > **Our solution ...**
DAkkS calibration certificate; (traceability, measuring uncertainty, internationally recognised)
-

KERN – Precision is our business

The KERN calibration laboratory for electronic balances and weights has been accredited by DKD since 1994 and today is one of the most modern and best-equipped DAkkS calibration laboratories for balances, test weights and force measurement in Europe.

Thanks to the high level of automation, we can carry out DAkkS calibration of balances, test weights and force-measuring devices 24 hours a day, 7 days a week.

Do you have any further requests or questions on this matter? We would be pleased to help you or visit us on the web at www.kern-lab.com

DAkkS calibration

Why? DAkkS calibration is always necessary when checking equipment (balance or test weight) is to be used in a QM process (e.g. to ISO 9000ff, GS 9000, TS 16949, VDA 6.1, FDA, GLP, GMP, GMP etc.)

What? Any checking equipment in proper condition can be DAkkS calibrated

How? Determination of accuracy throughout the world by a laboratory which is accredited to DIN EN ISO 17025. Traceability to internationally recognised standards. The DAkkS calibration certificate confirms both the measurement characteristics of the checking equipment and the general requirements for the control of checking equipment.

Where? Internationally recognised – this is monitored by ILAC (International Laboratory Accreditation Cooperation) and e.g. DAkkS (German calibration service) in Germany

When? The operator control the use of checking equipment and periodic recalibration time intervals themselves

Range of services:

- DAkkS calibration of balances with a maximum load of up to 50.000 kg
- DAkkS calibration of weights in the range of 1 mg – 2.500 kg. Calibrations can be carried out in the following classes: E1, E2, F1, F2, M1, M2, M3
- DAkkS calibration of force gauges and force transducers
- Volume determination for weights of accuracy class E1
- Measuring of sensitivity (magnetic characteristics)
- Factory calibration in various sizes:
- Force (sensors and measuring devices), hardness (Shore, UCI, Leeb, etc.), thickness of coatings and walls, torque wrench testing devices, and much more
- Conformity assessments and recalibration of balances and weights at the KERN verification point, working closely with the verification authorities

And on top of all these services, we also offer additional services – see page 212/213.

Balance & weight in the quality management system

Do you already use all the modules of the KERN precision package for maximum accuracy and reliability of your balance?

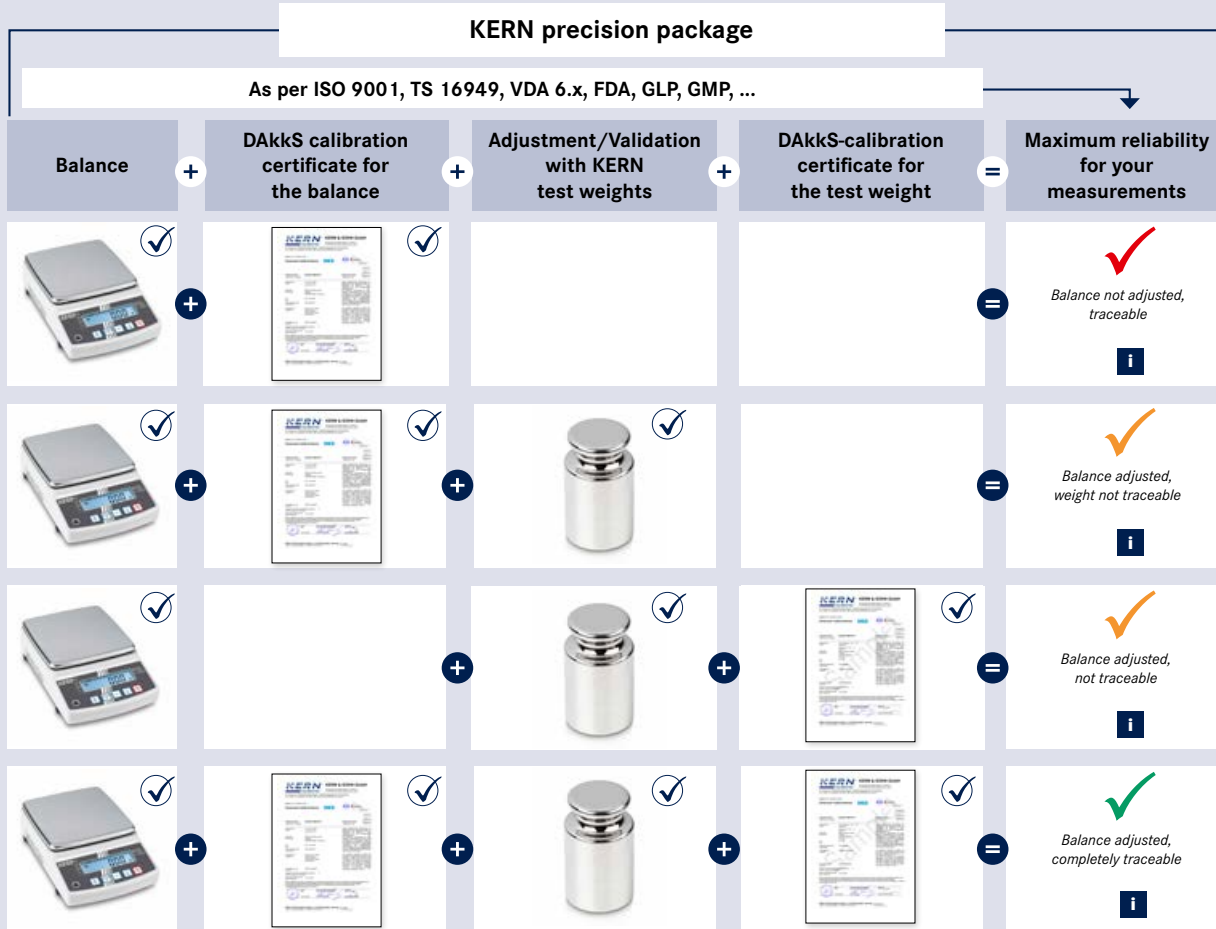

Information & ordering:
kern-sohn.com/qmb

The KERN calibration laboratory (D-K-19408-01-00)

KERN has a highly-automated DAkkS laboratory with accreditation to DIN EN ISO/IEC 17025 in the field of balances, test weights and force measurement. By using the most modern calibration technology with high-end calibration robots in fully air-conditioned laboratories, the measurement uncertainty and process times are reduced to a minimum, and also the quality of the calibration is increased.

As an accredited and certified calibration service provider with decades of experience, KERN offers you an extensive range of services, which will leave no demand unfulfilled. The accreditation applies to the extent specified in the appendix to the certificate D-K-19408-01-00.

We offer the following services:

Waagen:

- ▶ DAkkS calibration up to 50 t
- ▶ Minimum sample weight (in use)
- ▶ Usage accuracy
- ▶ Adjustment at the location of installation
- ▶ Certificate of conformity
- ▶ Equipment qualification:
 - > Design qualification (DQ)
 - > Installation qualification (IQ)
 - > Function qualification (OQ)
 - > Performance qualification (PQ)
 - > Maintenance qualification (MQ)
- ▶ Verification

Weights:

- ▶ DAkkS calibration up to 2.5 t (OIML classes E1 – M3)
- ▶ Volume determination for OIML class E1
- ▶ Measuring of sensitivity (magnetic characteristics)
- ▶ Verification

Force measuring devices and force transducers:

- ▶ DAkkS calibration up to 5 kN

Factory calibration for:

- ▶ Force measuring devices and force transducers ≤ 250 kN
- ▶ Hardness
- ▶ Layer thickness
- ▶ Material thickness
- ▶ Temperature of moisture analysers

Our commitment to satisfy our customers never stops. Perhaps this is one of the reasons why our roots can perhaps be traced so far back in history. **Discover the KERN route to success: fast - competent - reliable - versatile!**

The order process

- 1 You will receive a **reminder** that your test equipment is due or you will generate online a quotation for new or existing test equipment
- 2 Submission or collection of your test equipment
- 3 Initial inspection of your goods, to check that they are suitable for calibration, and are complete, etc.
- 4 You will get a detailed order confirmation
- 5 Our experts will carry out initial calibration
- 6 Checked for conformity with required tolerances and if required, any necessary actions which arise from this are carried out
- 7 Before these actions are carried out, we will contact you (in so far as no individual processing has been agreed with you beforehand)
- 8 After your approval the necessary actions will be implemented and the calibration will be completed
- 9 After that your test equipment will be returned to you without delay, together with the appropriate calibration certificates
- 10 We will monitor your recalibration periods and will send you a reminder about your next calibration, free of charge

Our service



► Reminder service

The continuous cyclic recalibration of your checking equipment is an integral part of the reliable management of test equipment. You can rely on us to support you, and we will remind you in time, free of charge, when the next recalibration is due. In addition, you have the option of managing your test equipment online by yourself (cf. 1, 10).

► Quote generator

You will be impressed by our price-to-performance ratio. Request a non-binding quotation or create it yourself to suit your specifications at www.kern-lab.com (cf. 1)

► Collection service

We will be pleased to arrange a pick up by our forwarding agent the goods from your premises. You only need to tell us the weight and dimensions of your package and leave the rest to us (cf. 2)

► Repair and reconditioning of balances and weights

KERN will get your weights back up to standard, regardless of the manufacturer. Whether it is adjustment, marking, sand blasting or lacquering - the aim here is compliance and long-term stability. Any repairs of balances and instruments which may be necessary can be carried out quickly and easily (cf. 5, 6)

► Individual processing

In order to avoid delays with future orders, we would be pleased to incorporate your individual requirements for future processing of such calibration results. Even for smaller issues such as the printing of calibration certificates (stapling, punching, double-sided) we can work to your requirements (cf. 8).

► Express service and dispatch

If you need a particularly fast service, you can use your DAkkS express service. You will receive your test equipment after only 2 days (cf. 9).

www.kern-lab.com – the central portal for everything you need to know about the extensive KERN calibration services

On our website you will always find the latest news and useful information about testing and measuring devices, calibration, legal metrology and expansions to our range of services. You will also find numerous online services on the website.

Database supported management of test equipment

Information on your test equipment which has been calibrated by us is stored in our database. In this way it is possible to make trend calculations. You will therefore get an overview about the long-term stability and trend behaviour of your test equipment as well as the necessary recalibration period can easily be determined and specified.

Paperless documentation

So there is no administrative effort, we can handle all calibration documentation in a paperless process. From quotation, through to order confirmation, delivery note and invoice right up to calibration certificate, you will receive all documents by e-mail or you can retrieve them online. Would you prefer to receive your certificate or your invoice in paper form, for example? Of course this is not a problem either. We will send you everything you require by post.

Calibration certificate download

By using our download service you can easily download your calibration certificates as soon as the calibration work is complete and you will have access to them at any time in the future. Simply create your user account on www.kern-lab.com and you will never have to look for your certificates again.

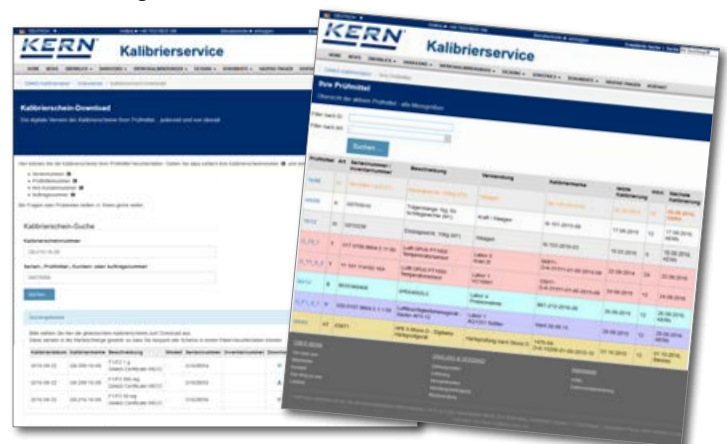

DAkKS Calibration of balances

Any balance will only give correct results if it is checked regularly, i.e. calibrated correctly and adjusted when required. A balance is only a reliable measuring and checking tool if it is calibrated and this calibration is documented. The issued DAkKS calibration certificates are proof of the metrological traceability to national and international standards, as required by the DIN EN ISO 9000 and DIN EN ISO/IEC 17025 standards, amongst others. KERN recommends a recalibration period of one year. The standard does not give a defined recalibration period. KERN recommends that, with intensive (daily) use, you to recalibrate your balance every 6 months and at normal (weekly) use, every 12 months.



THE ADVANTAGES OF USING THE KERN ON-SITE CALIBRATION:

- + **Calibration on-site** at your premises in the field of use
- + **No risk of damage** during transportation
- + **Low downtime**
- + **Cross-brand servicing**, basic inspection and adjustment by a specialist
- + You tell us **when you would like us to come**
- + **Device training** for qualified users



a) KERN on-site calibration (we visit you)

In Germany, KERN has a close-knit network of KERN DAkKS calibration laboratory employees, who can carry out on-site calibration of balances up to 50 tonnes.

This on-site testing service is metrologically recommended, as your balance is in its field of use and can be calibrated without any possible transportation problems.

Lower downtime and personal contact with our expert are the major benefits of this service.

Preparatory maintenance work by agreement. Prices for on-site calibration on request.

You tell us when you would like us to come, giving us details of the balances to be tested. Our on-site DAkKS calibration team will then get in touch with you immediately and will discuss the process with you at your premises – it's straight forward and professional.

This KERN calibration service is also independent of the brand.

Please feel free to contact us at Phone +49 7433 9933-400 or E-Mail: testservices-onsite@kern-sohn.com



THE ADVANTAGES OF USING THE KERN IN-HOUSE CALIBRATION:

- + **Short calibration time:** Test time in the laboratory is only four working days
- + **Competence:** Calibration laboratory, which complies with the highest standards in the area of metrology
- + **Independent management** of the recalibration calendar for your individual measuring instrument is possible
- + **Cross-brand service:** Measuring devices from any manufacturer can be calibrated independently
- + **Repair:** Any necessary repairs can be carried out immediately, if you wish



b) Calibration at the KERN factory (you send your balance to us)

Recommended for new devices and for balances which can be affordably transported, as then there is no need for us to travel to carry out the calibration on-site. Repairs can be carried out at the same time, quickly and in full.

The process would be as follows:

- Day 1: Send your balance to the KERN calibration laboratory in Balingen.
- Day 2 to 3: Evaluation and calibration of your balance by our specialists.
- Day 4: After positive validation, your balance is returned.

Please feel free to contact us at Phone +49 7433 9933-400 or E-Mail: recalibration-balances@kern-sohn.com

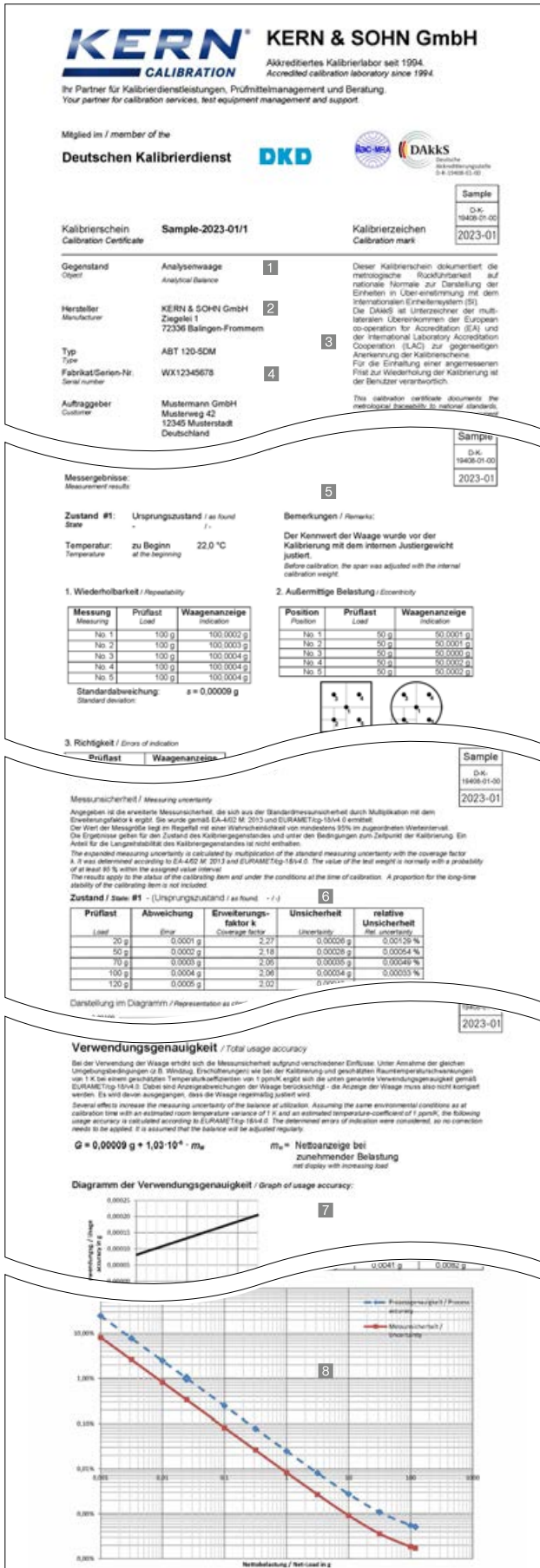

DAkKS calibration certificate for balances (extract)

- 1 Official document
- 2 Item to be calibrated
- 3 Traceability, see page 225

- 4 Identification/Applicant
- 5 Metrological component
- 6 Uncertainty of measurement, see page 225

- 7 Application accuracy, see page 223
- 8 Minimum weight of sample (additional price)

To get reliable weighing results you need to have calibrated balances. KERN offers you an extensive calibration service for your balances – You have the choice:

Recalibration

- The recalibration schedule depends on the frequency of use, the conditions of use and the safety requirements.
- We would recommend that you recalibrate your balances every 6 months if they are used intensively, and every 12 months with normal use.
- The KERN calibration service is independent of the brand.

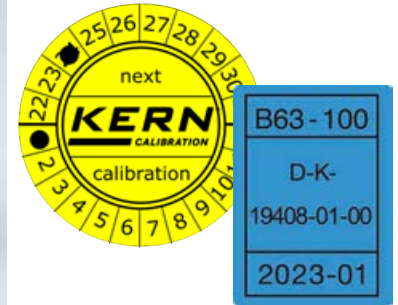

Initial calibration and recalibration of balance at the KERN factory

KERN

Price excl. of VAT ex works €

Weighing capacity		
Analytical balances		
[Max] ≤ 5 kg	963-101	182,-
[Max] > 5 kg	963-102	230,-
Precision balances/Industrial scales		
[Max] ≤ 5 kg	963-127	93,-
[Max] > 5 kg – 50 kg	963-128	112,-
[Max] > 50 kg – 350 kg	963-129	139,-
[Max] > 350 kg – 1500 kg	963-130	196,-
[Max] > 1500 kg – 2900 kg ¹⁾	963-131	260,-
[Max] > 2900 kg – 6000 kg ¹⁾	963-132	520,-
[Max] > 6000 kg – 12000 kg ¹⁾	963-133	590,-
Hanging scales/Crane scales		
[Max] ≤ 5 kg	963-127H	93,-
[Max] > 5 kg – 50 kg	963-128H	112,-
[Max] > 50 kg – 350 kg	963-129H	131,-
[Max] > 350 kg – 1500 kg	963-130H	235,-
[Max] > 1500 kg – 2900 kg	963-131H	355,-
[Max] > 2900 kg – 6000 kg	963-132H	590,-
[Max] > 6000 kg – 12000 kg ³⁾	963-133H	830,-
Preparation for recalibration (cleaning, adjustment, function test)	969-003R	24,-
Additional services		
Minimum weight of sample (for details see page 215)	969-103	10,-
Additional measurement points (as part of the) weighing test	963-140	5,20/ measurement point
Additional measurement points (as part of the) repeatability testing	963-140	5,20/ each further measurement point
DAkKS Express service with delivery time 48 hours (only on initial purchase, details see p. 210)	962-116	52,-/ scale
Express shipping: Express supplement for guaranteed delivery on the next working day (if ready for shipment before 12:00 noon) (other countries on request)	962-115 in GER only	21,-/ parcel

1) Floor scales & axle load scales only (Price per weighing panel). Please ask for further details.
 2) On request
 3) Processing time 4 working days
 4) Processing time 15 working days

Minimum weight of sample (in use)

What is the lightest item you can weigh on your balance, while still achieving accurate and reliable weighing results? What exactly is the limit?

The KERN minimum sample weight protocol accounts for the established minimum sample weight of your balance and its location of installation and use with the relative measuring uncertainty. With various safety coefficients and required weighing accuracy (process accuracy), depending on standard or quality-related requirements on the balance being used.

Adjustment at the location of installation

Why?

Adjustment at the location of installation is necessary, as the measuring results of balances depend on the local gravitational force (gravitational acceleration) and therefore depend on the location of use. KERN can carry this out just before shipping at the factor, individually to suit the location of installation.

What are the advantages of carrying out adjustment at the location of installation?

- The balance gives reliable measurement results at the location of installation.
- No time-consuming on-site adjustment necessary.
- You do not need a Service Engineer or any additional weights.
- The balance is ready for immediate use.

Certificate of conformity

With a certificate of conformity you get a statement about whether the balance meets your defined requirements.

In conjunction with a DAkkS calibration certificate it serves as documented proof that the balance fulfils the required process demands. When doing this the process owner for the balance can select from different temperature specifications – depending on its individual requirements:

The higher the selected safety coefficient, the higher the safety when using the balance in a particular process. Typical perturbations when using the balance e.g. small fluctuations in temperature are taken into account. In easily predictable conditions in a professional environment of use, KERN recommends a safety coefficient of 3. For critical processes, a correspondingly higher factor should be selected. The minimum sample weight protocol contains a diagram as well as a table, from which you can ascertain the minimum sample weight for your balance, depending on the process.

Pricing table for adjustment at the location of installation

Weighing capacity	KERN	Price excl. of VAT ex works €
[Max] ≤ 5 kg	961-247	39,-
[Max] > 5 – 50 kg	961-248	48,-
[Max] > 50 – 350 kg	961-249	56,-
[Max] > 350 – 1500 kg	961-250	90,-
[Max] > 1500 – 2900 kg	961-251	119,-
[Max] > 2900 – 6000 kg	961-252	240,-
[Max] > 6000 – 12000 kg	961-253	270,-

For adjustment to the location of installation you need the value for gravitational acceleration at the location of installation, which KERN can calculate using the point of use. The procedure is suitable for balances with a resolution of <60,000 d. For higher resolutions we recommend a balance with an internal adjusting weight or adjustment with a calibrated adjusting weight at the location of installation.

Conformity evaluation on the basis of the:	KERN	Price excl. of VAT ex works €
Usage accuracy*	relative	969-511
	absolute	969-512
Calibration results*	relative	969-513
	absolute	969-514
Measurements as manufacturer or customer specification	Foreign device	969-515
	Customer specifications	969-516
	KERN devices	969-517

relative = % / absolute = g

*as attachment to the DAkkS calibration certificate (Details see www.kern-lab.com)

Example for absolute customer tolerance (absolute) (Item no. 969-511):

No.	Tare	Load	Display	Deviation	Uncertainty	Customer tolerance	Conformity ¹⁾
1	0 g	500 g	500,00 g	0,00 g	± 0,013 g	± 0,05 g	<input checked="" type="checkbox"/>
2	0 g	1000 g	1000,00 g	0,00 g	± 0,015 g	± 0,05 g	<input checked="" type="checkbox"/>
3	0 g	1500 g	1500,01 g	0,01 g	± 0,017 g	± 0,05 g	<input checked="" type="checkbox"/>
4	0 g	2000 g	2000,01 g	0,01 g	± 0,020 g	± 0,10 g	<input checked="" type="checkbox"/>
5	0 g	3000 g	3000,02 g	0,02 g	± 0,022 g	± 0,10 g	<input checked="" type="checkbox"/>

1) Evaluation criteria: |[Deviation]| + [extended measuring uncertainty] ≤ [tolerance]

Documented quality of your balances in the log book

Consistently high product quality requires the use of measuring and test equipment that provides comprehensible, consistent and reproducible results. Hence, quality management systems require that measuring and test equipment produces a detailed traceable description and documentation of calibration results and conformity statements. Work not documented is work not done.

Equipment qualification is documentary evidence that a equipment is suitable for the intended purpose and is working faultlessly. A balance log book is used to record all activities and results required for the qualification and monitoring of balances during routine operation. This includes the installation and commissioning of the balances, routine tests, maintenance as well as the recording of special events (failures, repairs, change of location).

The structure of the balance log book is based on the qualification process of the balance. The requirements for the qualification system such as DIN EN ISO 9001, DIN EN ISO/IEC 17025, GLP/GMP, VDA must be taken into account. The log book supports the user in his/her daily work with the balance and is meant to serve as necessary evidence during inspections and audits. The responsibility for maintaining the log book and its appropriate use is to be borne by the user.

Our proposal: Count on our support!

KERN offers this qualification concept throughout. Our validation services are carried out on the spot by technicians of our calibration laboratory and comprise among other things: installation, measurement test inclusive DAkks calibration certificate as well as records in your qualification log book.

We give you advice already when selecting a new device, for example KERN ADB/ADJ, ALS/ALJ, ABS/ABJ, ACJ, ABT, ABP, PLS/PLJ, PNS/PNJ, EG-N, PBS/PBJ, PES/PEJ, about the options of device qualification, as required and will be happy to set up an appointment for qualification at the place of installation. We offer individual calibration and maintenance agreements for the periodically required requalification.

Further information can be found at www.kern-lab.com



Important elements of equipment qualification:



Design qualification (DQ)

With the design qualification, all requirements on which you as a user depend are defined. The purchase decision is made on the basis of the design specifications and the available devices. Careful selection in the DQ can prevent subsequent deficiencies.



Installation qualification (IQ)

All steps to be taken for the installation and commissioning of the equipment are described in detail in the installation qualification. These include among others:

- checking for completeness of delivery and assurance that the delivered equipment meets the required specifications
- a description of the ambient conditions at the place of installation
- proper installation and assurance that the equipment is ready for operation after installation
- documentation of equipment configuration and equipment settings
- Recording and installation of connected peripherals units



Function qualification (OQ)

The operational qualification describes the metrological test performed for the balance at the place of installation. In the course of this all parameters that define the efficiency of a measurement will be checked. Functional qualification is carried out with the help of a standard operating procedure (SOP) and recorded in a calibration certificate. The OQ must be carried out by trained staff with the help of qualified aids (such as certified weights that are traceable to an approved standard). Briefing / training of users must be assured and recorded in the OQ.



Performance qualification (PQ)

The PQ represents documented evidence that the balance or weighing system functions in the selected application as intended. This will be assured by a qualification test of the equipment under real conditions with respect to its surroundings and the problem definition (such as traceable data transmission). If the balance or weighing system is "merely" to be used for weighing it will not be necessary to carry out a PQ as the ability to function has already been proven during the metrological test (OQ).



Maintenance qualification (MQ)

The periodical maintenance, cleaning work and complete metrological test of the balance/weighing system is documented in the MQ by a trained authorised engineer. The results are documented on a DAkks calibration certificate. Maintenance is carried out with the help of a maintenance schedule.



If you are interested in a training for equipment qualification, please feel free to contact us at **+49 7433 9933-400** or testservices-onsite@kern-sohn.com

KERN & SOHN GmbH
 Akkreditiertes Kalibrierlabor seit 1994.
 Accredited calibration laboratory since 1994.

Ihr Partner für Kalibrierdienstleistungen, Prüfmittelmanagement und Beratung.
 Your partner for calibration services, test equipment management and support.

Mitglied im / member of the
Deutschen Kalibrierdienst DKD **DAkKS**

Sample
 D-K-19408-01-00
 2023-01

Kalibrierschein Sample-2023-01/1 **1**
 Calibration certificate

Kalibrierzeichen
 Calibration mark

Gegenstand Gewichtssatz, 1 mg - 1 kg **2**
 Object
 Klasse E2
 Set of weights, 1 mg - 1 kg
 Class E2

Hersteller KERN & Sohn GmbH
 Manufacturer
 Ziegelei 1
 D-72336 Balingen
 Germany **3**

Typ 313-052
 Type **3**

Fabrikat-/Serien-Nr. G123456789
 Serial number **4**

Auftraggeber Mustermann GmbH
 Customer **4**

Auftragsnummer 2020-123456789
 Order No.

Ort der Kalibrierung: Kalibrierlaboratorium KERN
 Place of calibration
 Calibration - Laboratory KERN

Umgebungsbedingungen: Die Kalibrierung wurde bei folgenden Umgebungsbedingungen ausgeführt.
 Ambient conditions
 The calibration was carried out under the following ambient conditions:

	von from	bis to	Unsicherheit uncertainty
Temperatur (°C) temperature	22,9	24,1	0,1
rel. Luftfeuchte (%) relative humidity	48,5	53,4	2,0
Luftdruck (hPa) air pressure	942,5	948,5	0,3

5

Magnetische Eigenschaften: Der Hersteller hat bestätigt, dass die Gewichtsstücke die magnetischen Eigenschaften gemäß R111:2004 enthalten.
 Magnetic properties
 The manufacturer has confirmed the compliance of the magnetic properties of the weight pieces with the OIML R111:2004.

Referenzgewichte: 123-D-K-19408-01-00-2019-05
 Standard weights

Material / angenommene Dichte:
 Material / assumed density

Nennwert nominal value	Dichte density	Unsicherheit uncertainty	Material material	Form shape
1 mg - 500 mg	7950 kg/m³	140 kg/m³	Edestanil Stainless steel	Drift Wire
1 g - 1 kg	8000 kg/m³	100 kg/m³	Edestanil Stainless steel	Knopf Cylindrical form

Messergebnisse:
 Measurement results

Nennwert nominal value	Kennzeichnung marking	konventioneller Wägewert conventional mass	Unsicherheit K=2 uncertainty	Fehlergrenze max. perm. error	Klasse ^a
1 mg		1 mg + 0,0010 mg	0,0020 mg	± 0,0090 mg	E2 ✓
2 mg		2 mg + 0,0005 mg	0,0020 mg	± 0,0090 mg	E2 ✓
2 mg	*	2 mg + 0,0016 mg	0,0020 mg	± 0,0090 mg	E2 ✓
5 mg		5 mg + 0,0010 mg	0,0020 mg	± 0,0090 mg	E2 ✓
10 mg		10 mg + 0,0009 mg	0,0020 mg	± 0,0090 mg	E2 ✓
20 mg		20 mg - 0,001 mg	0,003 mg	± 0,010 mg	E2 ✓
20 mg	*	20 mg + 0,001 mg	0,003 mg	± 0,010 mg	E2 ✓
50 mg		50 mg + 0,001 mg	0,004 mg	± 0,012 mg	E2 ✓
100 mg		100 mg + 0,001 mg	0,005 mg	± 0,016 mg	E2 ✓
200 mg		200 mg + 0,002 mg	0,006 mg	± 0,020 mg	E2 ✓
200 mg	*	200 mg + 0,003 mg	0,005 mg	± 0,020 mg	E2 ✓
500 mg		500 mg + 0,005 mg	0,008 mg	± 0,025 mg	E2 ✓
1 g		1 g + 0,002 mg	0,010 mg	± 0,030 mg	E2 ✓
2 g		2 g + 0,002 mg	0,013 mg	± 0,040 mg	E2 ✓
2 g	*	2 g + 0,002 mg	0,013 mg	± 0,040 mg	E2 ✓
5 g		5 g + 0,010 mg	0,016 mg	± 0,050 mg	E2 ✓
10 g		10 g - 0,007 mg	0,020 mg	± 0,065 mg	E2 ✓
20 g		20 g + 0,005 mg	0,026 mg	± 0,080 mg	E2 ✓
20 g	*	20 g + 0,015 mg	0,026 mg	± 0,080 mg	E2 ✓
50 g		50 g + 0,02 mg	0,03 mg	± 0,10 mg	E2 ✓
100 g		100 g + 0,01 mg	0,05 mg	± 0,15 mg	E2 ✓
200 g		200 g + 0,05 mg	0,10 mg	± 0,30 mg	E2 ✓
200 g	*	200 g - 0,00 mg	0,10 mg	± 0,30 mg	E2 ✓
500 g		500 g + 0,10 mg	0,26 mg	± 0,80 mg	E2 ✓
1 kg		1 kg + 0,1 mg	0,5 mg	± 1,6 mg	E2 ✓

6

7

8

Sample
 D-K-19408-01-00
 2023-01

DAkKS calibration certificate for test weights (extract).
 For more details on our calibration service and other useful information, please see the internet at www.kern-lab.com

- 1 Official document
- 2 Item to be calibrated
- 3 Traceability, see page 225
- 4 Identification/Applicant
- 5 Environmental conditions
- 6 Metrological component
- 7 Conventional mass
- 8 Uncertainty of measurement, see page 225

Traceable KERN test weights –

Calibration of test weights

Calibrated measuring equipment requires calibrated checking equipment. For balances, these are calibrated test weights, also called “standard weights”.

KERN will calibrate your test weights

- In all classes with permissible error limits E1–M3 according to OIML R111:2004 (for tolerance tables, see page 180), in sizes 1 mg to 2500 kg.
- With free nominal value
- Newton (N)
- Independent of design (special designs)

The advantages of using the KERN in-house calibration

You send your test weights to us.

- Excellent price performance ratio
- The quickest processing time
 - DAkKS standard service: 4 working days
 - DAkKS express service: 48 hrs (new weights)
- The most modern calibration methods with robot controlled comparators allow the most accurate calibration results and fastest throughput time
- KERN DAkKS calibration certificates are internationally recognised
- A calibration service which is independent of the brand
- KERN also reconditions existing customer weights (e.g. cleaning or readjustment)
- On request, we can also provide a pick-up and collection service with our parcel service

The advantages of using the KERN on-site calibration

We visit you.

We would be pleased to visit you within Germany and carry out the calibration of your reference standards to OIML classes M1–M3, 10 kg–2500 kg with permissible error limits, using our mobile MACOS system. Minimized downtime of your checking equipment and direct contact with our expert are the major benefits of this service. Price on request.

Recalibration

- The recalibration schedule depends on the frequency of use, the conditions of use and the safety requirements
- In terms of standardisation, no particular recalibration interval is specified
- We would recommend that you recalibrate your test weights every six months if they are used intensively, and every 12 months with normal use
- We would be pleased to monitor your recalibration schedule

Recalibration price of test weights (DAkkS calibration)

Class acc.	→ E1 with volume determination	E1 without volume determination	E2	F1/F2 * F2 only	M1/M2/M3					
Nominal value ↓	KERN	Price € excl. of VAT ex works	KERN	Price € excl. of VAT ex works	KERN	Price € excl. of VAT ex works	KERN	Price € excl. of VAT ex works	KERN	Price € excl. of VAT ex works
1 mg	-	-	962-251R	72,-	962-351R	32,-	962-451R	21,-	962-651R	17,-
2 mg	-	-	962-252R	72,-	962-352R	32,-	962-452R	21,-	962-652R	17,-
5 mg	-	-	962-253R	72,-	962-353R	32,-	962-453R	21,-	962-653R	17,-
10 mg	-	-	962-254R	72,-	962-354R	32,-	962-454R	21,-	962-654R	17,-
20 mg	-	-	962-255R	72,-	962-355R	32,-	962-455R	21,-	962-655R	17,-
50 mg	-	-	962-256R	72,-	962-356R	32,-	962-456R	21,-	962-656R	17,-
100 mg	-	-	962-257R	72,-	962-357R	32,-	962-457R	21,-	962-657R	17,-
200 mg	-	-	962-258R	72,-	962-358R	32,-	962-458R	21,-	962-658R	17,-
500 mg	-	-	962-259R	72,-	962-359R	32,-	962-459R	21,-	962-659R	17,-
1 g	963-231	235,-	962-231R	72,-	962-331R	32,-	962-431R	21,-	962-631R	17,-
2 g	963-232	235,-	962-232R	72,-	962-332R	32,-	962-432R	21,-	962-632R	17,-
5 g	963-233	235,-	962-233R	72,-	962-333R	32,-	962-433R	21,-	962-633R	17,-
10 g	963-234	235,-	962-234R	72,-	962-334R	32,-	962-434R	21,-	962-634R	17,-
20 g	963-235	235,-	962-235R	72,-	962-335R	32,-	962-435R	21,-	962-635R	17,-
50 g	963-236	235,-	962-236R	72,-	962-336R	32,-	962-436R	21,-	962-636R	17,-
100 g	963-237	235,-	962-237R	72,-	962-337R	40,-	962-437R	23,-	962-637R	19,-
200 g	963-238	235,-	962-238R	72,-	962-338R	40,-	962-438R	23,-	962-638R	19,-
500 g	963-239	235,-	962-239R	72,-	962-339R	40,-	962-439R	23,-	962-639R	19,-
1 kg	963-241	235,-	962-241R	72,-	962-341R	40,-	962-441R	23,-	962-641R	19,-
2 kg	963-242	520,-	962-242R	89,-	962-342R	49,-	962-442R	29,-	962-642R	20,-
5 kg	963-243	520,-	962-243R	89,-	962-343R	49,-	962-443R	29,-	962-643R	20,-
10 kg	963-244	520,-	962-244R	89,-	962-344R	49,-	962-444R	29,-	962-644R	20,-
20 kg	963-245	1280,-	962-245R	720,-	962-345R	64,-	962-445R	33,-	962-645R	25,-
50 kg	963-246	1500,-	962-246R	800,-	962-346R	74,-	962-446R	45,-	962-646R	27,-
100 kg	-	-	-	-	-	-	962-591R*	134,-	962-691R	72,-
200 kg	-	-	-	-	-	-	962-592R*	134,-	962-692R	72,-
500 kg	-	-	-	-	-	-	962-593R*	134,-	962-693R	72,-
1000 kg	-	-	-	-	-	-	-	-	962-694R	158,-
2000 kg	-	-	-	-	-	-	-	-	962-695R	290,-
1 mg-500 mg	-	-	962-250R	465,-	962-350R	220,-	962-450R	116,-	962-650R	72,-
1 mg-50 g	963-201	1330,-	962-201R	770,-	962-301R	360,-	962-401R	193,-	962-601R	123,-
1 mg-100 g	963-202	1450,-	962-202R	790,-	962-302R	395,-	962-402R	205,-	962-602R	129,-
1 mg-200 g	963-203	1670,-	962-203R	870,-	962-303R	455,-	962-403R	230,-	962-603R	145,-
1 mg-500 g	963-204	1770,-	962-204R	910,-	962-304R	485,-	962-404R	240,-	962-604R	151,-
1 mg-1 kg	963-205	1890,-	962-205R	980,-	962-305R	520,-	962-405R	250,-	962-605R	159,-
1 mg-2 kg	963-206	2460,-	962-206R	1040,-	962-306R	570,-	962-406R	290,-	962-606R	175,-
1 mg-5 kg	963-207	2750,-	962-207R	1080,-	962-307R	610,-	962-407R	305,-	962-607R	185,-
1 mg-10 kg	963-208	3130,-	962-208R	1120,-	962-308R	650,-	962-408R	330,-	962-608R	193,-
1 g-50 g	963-215	960,-	962-215R	340,-	962-315R	149,-	962-415R	78,-	962-615R	48,-
1 g-100 g	963-216	1050,-	962-216R	370,-	962-316R	178,-	962-416R	89,-	962-616R	57,-
1 g-200 g	963-217	1280,-	962-217R	445,-	962-317R	235,-	962-417R	113,-	962-617R	70,-
1 g-500 g	963-218	1390,-	962-218R	490,-	962-318R	270,-	962-418R	126,-	962-618R	79,-
1 g-1 kg	963-219	1520,-	962-219R	520,-	962-319R	300,-	962-419R	138,-	962-619R	85,-
1 g-2 kg	963-220	2130,-	962-220R	600,-	962-320R	370,-	962-420R	174,-	962-620R	103,-
1 g-5 kg	963-221	2500,-	962-221R	620,-	962-321R	415,-	962-421R	192,-	962-621R	111,-
1 g-10 kg	963-222	2910,-	962-222R	670,-	962-322R	450,-	962-422R	210,-	962-622R	120,-

Additional costs for preparation, overhaul and adjustment before the calibration

Preparation of weights (e.g. cleaning, etc.)

Single weight	969-001R	5,-
Weight set	969-002R	20,-

Subsequent services are carried out after confirmation

Continued overhaul of weights (e.g. wet-cleaning, markings, repair, special packaging, adjustment E1 (DAkkS only), E2 ...)	969-005R	T & M basis
Adjustment, per weight only available for weights with adjustment chamber (F1-M3)	969-010R	15,-

Second calibration after adjustment or substitution, per weight

Class E1	969-210R	63,-
Class E1 incl. volume determination	969-211R	230,-
Class E2	969-310R	30,-
Class F1/F2	969-410R	20,-
Class M1-M3	969-610R	16,-

Testing of magnetic properties according to OIML R 111:2004, per weight 961-115(R) 15,-

Calibration of NON-OIML test weights, additional price per weight - 8,-

KERN

Price
excl. of VAT
ex works
€

KERN DAkkS Express Service

DAkkS standard service Class E2-M3 4 working days

DAkkS standard service Class E1, 1 mg-500 mg, and recalibration 10 working days
1 g-10 kg with a known volume

Class E1, ≥ 1 g, incl. volume determination (new weights) 15 working days



DAkkS Express service in 48 hours except for class E1

- Urgent order is received at KERN by 12:00 noon at the latest
- Ready for shipping at KERN within two working days, at 12:00 noon
- Return by standard parcel service or express shipping (Costs and processing time on request)
- Additional cost for DAkkS Express Service, for each KERN test weight KERN KERN 962-115 € 21,-
- For Express shipping, see page 214

Verification prices for test weights and (crane) scales

Class acc. OIML R 111:2004	→ E2 with verification certificate		F1 with verification certificate		M1 with verification certificate		
	Nominal value ↓	KERN	Price excl. of VAT ex works €	KERN	Price excl. of VAT ex works €	KERN	Price excl. of VAT ex works €
	1 mg	952-351	51,-	952-451	44,-	952-651	30,-
	2 mg	952-352	51,-	952-452	44,-	952-652	30,-
	5 mg	952-353	51,-	952-453	44,-	952-653	30,-
	10 mg	952-354	51,-	952-454	44,-	952-654	30,-
	20 mg	952-355	51,-	952-455	44,-	952-655	30,-
	50 mg	952-356	51,-	952-456	44,-	952-656	30,-
	100 mg	952-357	51,-	952-457	44,-	952-657	30,-
	200 mg	952-358	51,-	952-458	44,-	952-658	30,-
	500 mg	952-359	51,-	952-459	44,-	952-659	30,-
	1 g	952-331	51,-	952-431	44,-	952-631	30,-
	2 g	952-332	51,-	952-432	44,-	952-632	30,-
	5 g	952-333	51,-	952-433	44,-	952-633	30,-
	10 g	952-334	51,-	952-434	44,-	952-634	30,-
	20 g	952-335	51,-	952-435	44,-	952-635	30,-
	50 g	952-336	51,-	952-436	44,-	952-636	30,-
	100 g	952-337	57,-	952-437	44,-	952-637	30,-
	200 g	952-338	57,-	952-438	46,-	952-638	30,-
	500 g	952-339	57,-	952-439	46,-	952-639	30,-
	1 kg	952-341	57,-	952-441	46,-	952-641	30,-
	2 kg	952-342	65,-	952-442	51,-	952-642	32,-
	5 kg	952-343	65,-	952-443	51,-	952-643	32,-
	10 kg	952-344	65,-	952-444	51,-	952-644	40,-
	20 kg	952-345	75,-	952-445	53,-	952-645	46,-
	50 kg	-	-	952-446	64,-	952-646	48,-
	1 mg-500 mg	952-350	255,-	952-450	134,-	952-650	84,-
	1 mg-50 g	952-301	420,-	952-401	220,-	952-601	140,-
	1 mg-100 g	952-302	455,-	952-402	240,-	952-602	149,-
	1 mg-200 g	952-303	510,-	952-403	265,-	952-603	166,-
	1 mg-500 g	952-304	550,-	952-404	275,-	952-604	174,-
	1 mg-1 kg	952-305	570,-	952-405	290,-	952-605	183,-
	1 mg-2 kg	952-306	660,-	952-406	330,-	952-606	200,-
	1 mg-5 kg	952-307	710,-	952-407	355,-	952-607	215,-
	1 mg-10 kg	952-308	750,-	952-408	380,-	952-608	220,-
	1 g-50 g	952-315	168,-	952-415	97,-	952-615	64,-
	1 g-100 g	952-316	200,-	952-416	103,-	952-616	68,-
	1 g-200 g	952-317	260,-	952-417	131,-	952-617	81,-
	1 g-500 g	952-318	300,-	952-418	145,-	952-618	90,-
	1 g-1 kg	952-319	325,-	952-419	159,-	952-619	99,-
	1 g-2 kg	952-320	405,-	952-420	200,-	952-620	118,-
	1 g-5 kg	952-321	450,-	952-421	220,-	952-621	129,-
	1 g-10 kg	952-322	495,-	952-422	245,-	952-622	138,-

KERN verification delivery time

Standard verification service
Class E2 - M1 6 working days

Additional costs KERN Price
for preparation, overhaul excl. of VAT
and adjustment before the ex works
verification €

Preparation of weights (e.g. cleaning, etc.)

Single weight	969-008R	5,-
Weight set	969-009R	19,-

Subsequent services are carried out after confirmation

Continued overhaul of weights (e.g. wet-cleaning, markings, repair, special packaging, adjustment E2 ...)	969-005R	T & M basis
---	----------	-------------

Adjustment, per weight only available for weights with adjustment chamber (F1/F2 - M1)	969-010R	15,-
--	----------	------

Verification after adjustment or substitution, per weight

Class E2	969-310R	30,-
Class F1/F2	969-410R	20,-
Class M1	969-610R	16,-

Verification prices for balances

	Reverification	Price excl. of VAT ex works €
	KERN	€
Accuracy class I (precision balances) ¹⁾		
[Max] ≤ 5 kg ¹⁾	950-101R	225,-
[Max] > 5 kg ¹⁾	950-102R	290,-
Accuracy class II (precision balances) ¹⁾		
[Max] ≤ 5 kg ¹⁾	950-116R	114,-
[Max] > 5 kg - 50 kg ¹⁾	950-117R	139,-
[Max] > 50 kg - 350 kg ¹⁾	950-118R	215,-
Accuracy class III-IV ¹⁾		
Bench scales and industrial scales (excl. crane scales)		
[Max] ≤ 5 kg ¹⁾	950-127R	109,-
[Max] > 5 kg - 50 kg ¹⁾	950-128R	109,-
[Max] > 50 kg - 350 kg ¹⁾	950-129R	175,-
[Max] > 350 kg - 1500 kg ¹⁾	950-130R	255,-
[Max] > 1500 kg - 2900 kg ¹⁾	950-131R	355,-
[Max] > 2900 kg - 6000 kg ¹⁾	950-132R	550,-
Crane scales		
[Max] > 50 kg - 350 kg ¹⁾	950-129HR	190,-
[Max] > 350 kg - 1500 kg ¹⁾	950-130HR	315,-
[Max] > 1500 kg - 2900 kg ¹⁾	950-131HR	455,-
[Max] > 2900 kg - 6000 kg ¹⁾	950-132HR	690,-
[Max] > 6000 kg - 12000 kg ¹⁾	950-133HR	1100,-

¹⁾ Processing time 4 working days, ²⁾ Processing time 15 working days, ¹⁾²⁾ Preparation of reverification of balances, 969-006R, € 24,-

The force gauge

Accredited calibration with DAkkS calibration certificate for force gauges

The KERN calibration laboratory is at your side when you need to calibrate according to DAkkS.

From the transducer to the full measuring chain, we are happy to take care of traceable calibration of your test equipment for you. Our accreditation includes the calibration of tensile and pressure force up to 5 kN according to the standards DIN EN ISO 376 and DKD-R 3-3, each with the Newton (N) display unit for a complete measuring chain (situation A) or voltage ratio/transmission coefficient (mV/V, situation B).

Below you will find a comparison of which standard meets which criteria:

Comparison of DIN EN ISO 376 and DKD-R 3-3

	ISO 376	DKD-R 3-3
Standardization	ISO standard (internationally standardized)	Standard of the DKD (Germany)
Measuring equipment	Force transducers and complete measuring chains	Force transducers and complete measuring chains
Area of application	Specifically force gauges for the testing of testing equipment	General force gauges
Number of power stages	8	5
Classification/Assessment	Classification in classes 00; 0,5; 1 and 2	None in standard
Test sequences	Fixed procedure	Sequences A, B, C, D possible Standard is sequence A B, C and D are reduced sequences, relevant previous knowledge is necessary
Summary	Higher-quality calibration, as 8 force levels are calibrated	High-quality calibration, reduced sequences with less effort possible

We can offer you a calibration solution for the following situations:

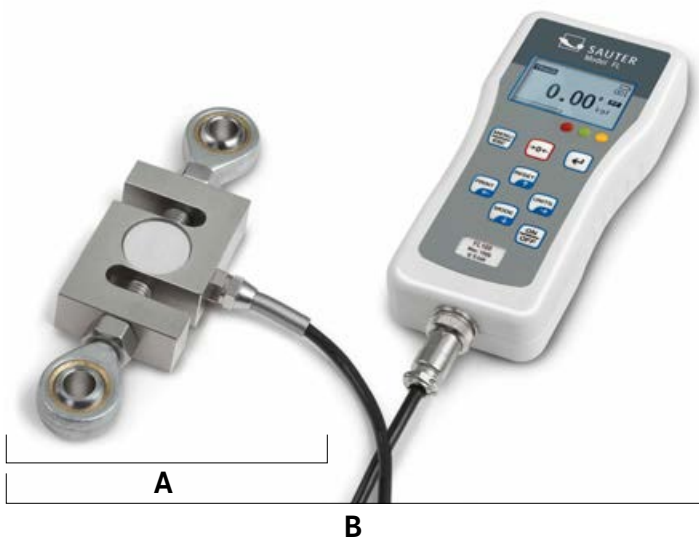

Situation A:

Separate force transducer, display unit mV/V

► See also tables, right side

Situation B:

Complete force gauge (N), consisting of transducer, amplifier and display, display unit N

You can find further information on this topic at: www.kern-lab.com

KERN CALIBRATION KERN & SOHN GmbH
 Akkreditiertes Kalibrierlabor seit 1994. Accredited calibration laboratory since 1994.
 Ihr Partner für Kalibrierdienstleistungen, Prüfmittelmanagement und Beratung. Your partner for calibration services, test equipment management and support.

Mitglied im / member of the
Deutschen Kalibrierdienst DKD **DAkkS**

Kalibrierschein / Calibration Certificate: **Sample-2023-01**
 Kalibrierzeichen / Calibration mark: **Sample-2023-01**

Gegenstand / Objekt: Kraftmessgerät / Force gauge
 Max. 1000 N, d_n 0,5 N

Hersteller / Manufacturer: Sauter GmbH
 72336 Balingen, Deutschland

Typ / Type: FH 1K

Seriennummer / Serial number: SA20H02287

Auftraggeber / Customer: Musterfirma GmbH
 Musterstraße 1, 12345 Musterort

Messwerte (Zugkraft) / Measurement results (tension force):

Ausrichtung / Winkel Kraft	Ausgangsposition / initial position		120°		240°	
	R1	R2	R3	R4	R5	R6
0 N	0,0 N	0,0 N	0,0 N	0,0 N	0,0 N	0,0 N
200,0 N	-199,5 N	-199,5 N	-199,5 N	-200,0 N	-199,5 N	-200,0 N
400,0 N	-399,5 N	-399,5 N	-399,5 N	-399,5 N	-399,5 N	-399,5 N
600,0 N	-599,5 N	-599,5 N	-599,5 N	-599,5 N	-599,5 N	-599,5 N
800,0 N	-799,5 N	-799,5 N	-799,5 N	-799,5 N	-799,5 N	-799,5 N
1000,0 N	-999,5 N	-999,5 N	-999,5 N	-999,5 N	-999,5 N	-999,5 N
0 N	0,0 N	0,0 N	0,0 N	0,0 N	0,0 N	0,0 N

Messergebnisse (Zugkraft) / Measured values (tension force):

Aus den oben aufgeführten Messwerten ergeben sich die folgenden Messergebnisse:
 The following measurement results are calculated using the measured values above:

Rel. Kalibrierverfälschung / Rel. cal. max. load error: $K_c = 0,000\%$
 Rel. Nullpunktabweichungen - Rel. zero error: $F_0 = 0,000\%$ (R1), $0,000\%$ (R2), $0,000\%$ (R3/R4), $0,000\%$ (R5/R6)

Kraft / force	mittl. Mittelwert \bar{x} / average \bar{x}	rel. Wiederholgenauigkeit σ_r / rel. repeatability σ_r	rel. Vergleichspräzision σ_{rel} / rel. reproducibility σ_{rel}	rel. Umrahmgenauigkeit σ_{rel} / rel. frame accuracy σ_{rel}
200,0 N	-199,5 N	0,000%	0,000%	+0,251%
400,0 N	-399,5 N	0,000%	0,000%	0,000%
600,0 N	-599,5 N	0,000%	0,000%	0,000%
800,0 N	-799,5 N	0,000%	0,000%	+0,063%
1000,0 N	-999,5 N	+0,000%	+0,000%	0,000%

Angaben in % die erweiterte Messunsicherheit, die sich aus der Standardmessunsicherheit durch Multiplikation mit dem Einflusfaktor $k = 2$ ergibt. Die wurde gemäß EA-402:2013 und DKD-R 3-3 ermittelt und gilt jeweils für Einstellungen zwischen der angegebenen Kalibrier- und der Kalibriernennkraft. Der Wert der Messgröße liegt mit einer Wahrscheinlichkeit von mindestens 95% im angegebenen Wertebereich.

DAkkS Calibration certificate for force-measuring devices (extract).

Prices for DAkkS calibration of force gauges and force transducers

Situation A: Force transducer (voltage ratio, in mV/V)^{*1,2}

ISO 376 (8 stages)			DKD-R 3-3 (5 stages, sequence A)		
KERN	Measuring range	Price € ex works excl. of VAT	KERN	Measuring range	Price € ex works excl. of VAT
Tensile force:					
963-161IV (R)	≤ 500 N	225,-	963-161V (R)	≤ 500 N	210,-
963-162IV (R)	≤ 2 kN	270,-	963-162V (R)	≤ 2 kN	250,-
963-163IV (R)	≤ 5 kN	350,-	963-163V (R)	≤ 5 kN	325,-
Compression force:					
963-261IV (R)	≤ 500 N	225,-	963-261V (R)	≤ 500 N	210,-
963-262IV (R)	≤ 2 kN	270,-	963-262V (R)	≤ 2 kN	250,-
963-263IV (R)	≤ 5 kN	350,-	963-263V (R)	≤ 5 kN	325,-
Tensile and Compression force:					
963-361IV (R)	≤ 500 N	375,-	963-361V (R)	≤ 500 N	350,-
963-362IV (R)	≤ 2 kN	450,-	963-362V (R)	≤ 2 kN	420,-
963-363IV (R)	≤ 5 kN	600,-	963-363V (R)	≤ 5 kN	550,-

Situation B: Complete force gauge (in N)^{*2}

ISO 376 (8 stages)			DKD-R 3-3 (5 stages, sequence A)		
KERN	Measuring range	Price € ex works excl. of VAT	KERN	Measuring range	Price € ex works excl. of VAT
Tensile force:					
963-161I (R)	≤ 500 N	186,-	963-161 (R)	≤ 500 N	168,-
963-162I (R)	≤ 2 kN	225,-	963-162 (R)	≤ 2 kN	205,-
963-163I (R)	≤ 5 kN	310,-	963-163 (R)	≤ 5 kN	285,-
Compression force:					
963-261I (R)	≤ 500 N	186,-	963-261 (R)	≤ 500 N	168,-
963-262I (R)	≤ 2 kN	225,-	963-262 (R)	≤ 2 kN	205,-
963-263I (R)	≤ 5 kN	310,-	963-263 (R)	≤ 5 kN	285,-
Tensile and Compression force:					
963-361I (R)	≤ 500 N	335,-	963-361 (R)	≤ 500 N	305,-
963-362I (R)	≤ 2 kN	415,-	963-362 (R)	≤ 2 kN	375,-
963-363I (R)	≤ 5 kN	560,-	963-363 (R)	≤ 5 kN	500,-

Factory calibration for force

Situation A: Force transducer (voltage ratio, in mV/V)^{*1,2}

Situation B: Complete force gauge (in N)^{*2}

KERN	Measuring range	Price € ex works excl. of VAT	KERN	Measuring range	Price € ex works excl. of VAT
Tensile force:					
961-161V (R)	≤ 500 N	210,-	961-161 (R)	≤ 500 N	168,-
961-162V (R)	≤ 2 kN	250,-	961-162 (R)	≤ 2 kN	205,-
961-163V (R)	≤ 5 kN	325,-	961-163 (R)	≤ 5 kN	285,-
961-164V (R)	≤ 20 kN	415,-	961-164 (R)	≤ 20 kN	370,-
961-165V (R)	≤ 50 kN	415,-	961-165 (R)	≤ 50 kN	370,-
961-166V (R)	≤ 250 kN	445,-	961-166 (R)	≤ 120 kN	410,-
Compression force:					
961-261V (R)	≤ 500 N	210,-	961-261 (R)	≤ 500 N	168,-
961-262V (R)	≤ 2 kN	250,-	961-262 (R)	≤ 2 kN	205,-
961-263V (R)	≤ 5 kN	325,-	961-263 (R)	≤ 5 kN	285,-
961-264V (R)	≤ 20 kN	415,-	961-264 (R)	≤ 20 kN	370,-
961-265V (R)	≤ 50 kN	415,-	961-265 (R)	≤ 50 kN	370,-
961-266V (R)	≤ 250 kN	445,-	961-266 (R)	≤ 120 kN	410,-
Tensile and Compression force:					
961-361V (R)	≤ 500 N	350,-	961-361 (R)	≤ 500 N	305,-
961-362V (R)	≤ 2 kN	420,-	961-362 (R)	≤ 2 kN	375,-
961-363V (R)	≤ 5 kN	550,-	961-363 (R)	≤ 5 kN	500,-
961-364V (R)	≤ 20 kN	590,-	961-364 (R)	≤ 20 kN	550,-
961-365V (R)	≤ 50 kN	590,-	961-365 (R)	≤ 50 kN	550,-
961-366V (R)	≤ 250 kN	650,-	961-366 (R)	≤ 120 kN	600,-

(R): Recalibration

For each force gauge without interface or from other manufacturers we charge a surcharge of € 10,- for the additional effort.

^{*1} Compatibility with our amplifiers required

^{*2} Installation in our measuring equipment required

Factory calibration certificates

As DAkkS calibration certificates cannot be offered for all measuring devices or measurement sizes, or where it is not customary, we then offer factory calibration certificates. These calibration certificates meet international standards and are particularly suitable as proof of exacting calibration in the monitoring of your checking equipment, for example:

- Mechanical balances (spring balances, etc.)
- Force-measuring devices up to 250 kN (see also page 221)
- Measuring devices for layer thickness 0 µm – 2000 µm
- Hardness testing devices in accordance with Leeb tests
- Ultrasonic material thickness testing device 25 mm - 300 mm

We carry out calibrations independent of brand. In order to avoid any unnecessary delays when processing your order, please send us the technical documents and necessary accessories with the checking device. Calibration time 4 working days.

For up-to-date information on test services for further measuring variables please see p. 221 or visit our website www.kern-lab.com

KERN	Measuring device	Measuring range	Price excl. of VAT ex works €
Factory calibration			
961-110	Coating thickness	≤ 2000 µm F or N	150,-
961-112	Coating thickness	≤ 2000 µm FN	210,-
961-113	Wall thickness (ultra sound)	≤ 300 mm (in stainless steel)	150,-
961-114	Wall thickness (Test blocks)	≤ 300 mm	187,-
961-170	Hardness comparison plate (Shore)	For sets up to 7 plates	119,-
961-131	Hardness tester (Leeb)	400 – 800 HLD	150,-
961-132	Hardness comparison plate (Leeb)	Hardness comparison plate (for Leeb durometer)	150,-
961-270	Hardness (UCI)	200 – 800 HV	325,-
961-150	Length	≤ 300 mm	150,-
961-190	Light	≤ 200000 lx	205,-
961-100	Mechanical balances/spring balances	≤ 5 kg	89,-
961-101	Mechanical balances/spring balances	> 5 – 50 kg	110,-
961-102	Mechanical balances/spring balances	> 50 – 350 kg	131,-
961-103	Mechanical balances/spring balances	> 350 – 1500 kg	205,-
961-102K	Digital dynamometer KERN MAP	≤ 130 kg	150,-
961-120 (R)	Torque wrench test devices	1 Nm - 200 Nm	210,-
964-305	Temperature calibration for moisture analyzer*		174,-
Additional services			
962-116	Express service with 48 hour delivery		52,-/instrument

(R): Recalibration

For each force gauge without interface or from other manufacturers we charge a surcharge of € 10,- for the additional effort.

*Calibration available for the following models:

DAB 100-3, DAB 200-2, DBS-60-3, DLB 160-3A, MLS 150-2A, MLS 65-3A, MLB 50-3N, MLB 50-3C, MLB 50-3, DLT 100-3N, MLS 50-3D, MLS 50-3C

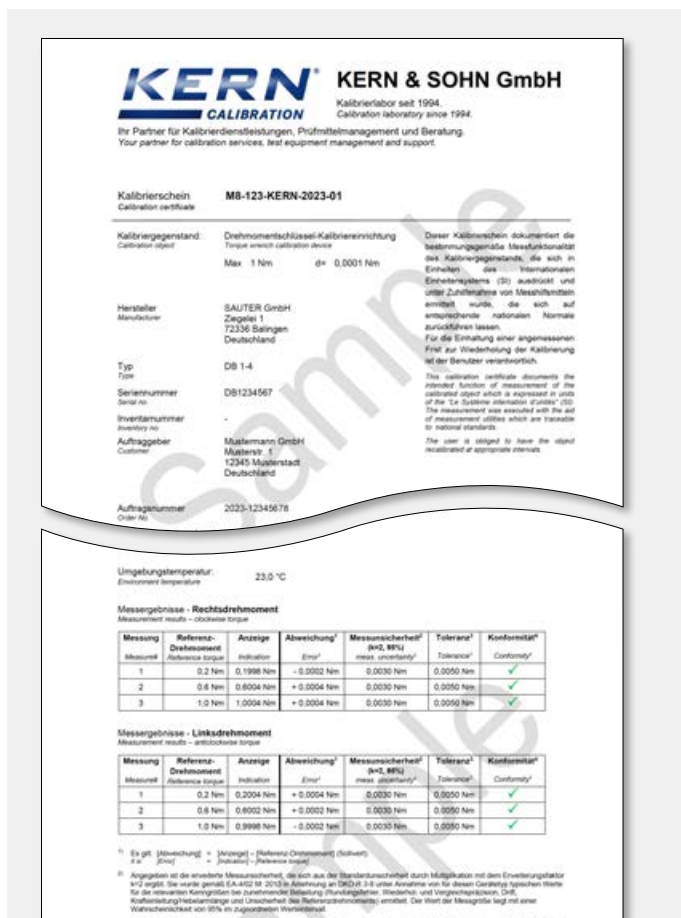

Factory calibration certificate for torque wrench test devices
(extract from the factory calibration certificate)
Further details on the internet at www.kern-lab.com

A**Accuracy classes for test weights**E, F, M ▶ **Error limit classes****Adjusting of measurement equipment**

Precise setting of a measurement value via a professional intervention in the measurement system.

Adjusting the weighing range of a balance

Either with the external test weight via the **adjusting program CAL**, or with the **internal automatic adjustment** resp. **adjusting switch**. It is necessary with variations in temperature, a change of environmental conditions, change of location, etc.

Recommended as a daily check routine.

Alibi memory

For weighings where verification is mandatory, and which are to be analysed and processed by a PC (e.g. printing out a packing list using a PC instead of a printer connected directly to the balance) electronic archiving is required by the metrological authorities by a verifiable data memory which cannot be manipulated. Alibi memories from KERN fulfil this requirement. They are for paperless archiving of weighing results. For KERN products the alibi memory is fitted inside the balance, right between where the weight is determined and the output to the PC.

All data transferred to the PC is stored with date, time and all important weights for at least three months. These stored data strings can be displayed on the balance at any time. The data in the alibi memory can be deleted, but not changed.

Application accuracy

Allowance for measuring uncertainty during practical use of a balance. Is given in the appendix to the DKD calibration certificate.

ATEX

Derived from **AT**mosphère **EX**plosibles. (explosive atmosphere). A synonym for EU guidelines, which controls the quality and use of equipment in hazardous industrial environments, where there is explosion danger, e.g. by handling of flammable substances, which are present in high concentrations in the form of gas, mist, vapour or dust. Therefore see also directives 2014/34/EU as well as 1999/92/EU.

B**Balances which are verified/not approved for verification**

Metrologically almost identical. For verified balances certain details are regulated by law, e.g. software changes and additional markings.

C**CAL**

Adjusting the balance is triggered with an external test weight by using the CAL key on the key pad or on the touch display of the display device or the CAL menu option. This will guarantee the consistent high accuracy of the balance.

Calibration of measurement equipment

Determination of the precision of a measurement value without intervention in the measurement system. Example: to check a balance you load a ▶ **test weight** upon it. The term "Calibrating" was formerly also used for ▶ **Adjusting**.

Calibration Certificate DKD/DAkkS

See product group 18 "Calibration service"

Calibration or verification

DAkkS-Calibration is possible for every balance in perfect condition. DAkkS calibration (DKD) is a private service monitored by the state for ensuring high quality requirements according to ISO 9000ff and others, e.g. in production or research. **Verifying (conformity assessment)** is only possible for type-approved balances marked with the green **M** ▶ **Verification**

Commercial error limit

Permitted tolerance (plus and minus) of measuring devices where verification is mandatory when used within their verification validity period. This tolerance is double the permissible error limit, in so far as this is not specified otherwise in the Weights and Measures Act).

Conformity assessment

Procedure for confirming warranted characteristics in accordance with recognised rules. For balances this relates to verification.

Conformity declaration from the manufacturer

The manufacturer declares that the product fulfils the applicable EU directives. With electronic balances this is always in conjunction with the CE mark.

Control of measuring equipment in the QM system in conjunction with quality standards

An organisation certified to a quality standard such as DIN EN ISO 9001 ff. e.g. a production plant is obliged to adhere to a defined quality standard within the framework of its quality management system. To do this, it is imperative to have a measurement equipment which is working accurately. Chapter 7.1.5 "Resources for monitoring and measuring" of DIN EN ISO 9001:2015-11 states that measuring equipment must be calibrated at defined intervals and before use. The measurement devices and measurement standards needed to do this must:

- be traced back to international or national standards.
(▶ **Traceability to the National Standard**)
 - their uncertainty of measurement must be known- they must be marked with a clear identification
 - the test must be documented
- The ▶ **DAkkS calibration (DKD)** fulfils all these requirements.

Conventional mass of weights

The problem is the air movement, which makes the weight appear lighter. In order to avoid this "distortion" in daily use, all weights are adjusted to the unit specifications given in R111, e.g. it is accepted that: material density of the weights is 8000 kg/m³, air density is 1.2 kg/m³ and measuring temperature is 20°C.

Counting resolution

The counting resolution is calculated in points from the ratio of the weighing range [Max] divided by the smallest part weight. It is a statement of counting accuracy.

D**DAkkS = German accreditation authority****▶ Calibration Certificate DKD/DAkkS**

See product group 18 "Calibration service"

Data interface

To connect the balance to a printer, PC, network or a second balance. Typical interfaces are, for example, RS-232, RS-485, USB, Bluetooth, LAN, Digital I/O, DUAL, LAN etc. The interface parameters can be set using the balance. The interfaces available are stated in the model description.

Density determination

One of the main areas of application for laboratory balances is determining densities, e.g. determining the specific weight of liquids and solids. To do this you will need a highly accurate precision or analytical balance and a density set. It is particularly convenient if the balance can calculate and display the density right away.

It has become apparent that by means of weighing when in the process of determining the density of liquids and solids according to the buoyancy method particularly accurate results can be obtained (Archimedes' principle).

- a) Density determination of liquids: By means of measuring the buoyancy with a glass plummet with known volume immersed in the liquid to be measured
- b) Density determination of solid bodies:

$$\rho = \frac{A}{A-B} \cdot \rho_0$$

ρ = Density of sample

A = Weight of sample in air

B = Weight of sample in auxiliary liquid

ρ_0 = Density of the auxiliary liquid

Glossary

Applications:

- Pre-packaged goods control, whenever a product is sold according to its volume [cm³]. This volume is calculated with weight [g] : density [g/cm³].
- Materials analysis

DMS = Strain gauge



An electrical resistor strip that is glued to an elastic deforming body made of aluminium. As the strain gauge is mechanically deformed its resistance value changes, allowing the measured value to be calculated.

Draught shield

Required for balances with ► **Readout**
d ≤ 1 mg, to avoid disturbing air movements.

Dual-range balance

As the load increases, the balance switches automatically to the next largest range, for both, weighing range [Max] as well as readout [d].

E

Error limit classes for test weights according to EU directive OIML R111

For further details, see product group 17 "Test weights"

F

FACTORY

These options can only be carried out at KERN factory.

FORCE = Electromagnetic force compensation



A counterforce is created by means of a coil in a permanent magnet. This counterforce is the same as the load of the weight being measured on the scale and therefore equalising. The measured value is calculated via the change in the coil current.

G

GLP = Good Laboratory Practice

► **ISO/GLP**

Gravitational acceleration

► **Gravitational force**

Gravitational force

very important influence for precise electronic balances. Due to the varying influence balances have to be ► **adjusted at the location of use.**

H

HACCP

= **Hazard Analysis and Critical Control Points (HACCP)** The HACCP concept is a preventative system, which is designed to guarantee the safety of foodstuffs EC regulation 852/2004 mandates the use of the HACCP concept for all companies which are involved in production, processing and sales of foodstuffs.

ISO 9000ff/DIN EN ISO 9000ff

Quality Management System in the form of a DIN Norm for quality assurance in a factory.

ISO calibration/ISO certificate = factory calibration certificate

Testing measurement devices for accuracy in accordance with a procedure which is recognised, but not accredited.

ISO/GLP record keeping



Quality Assurance Systems demands record keeping of weighing results and correct adjusting of the balance, giving details of date, time and balance identification. The easiest way to obtain this documentation is by means of a connected printer.

J

Junction Box

For connection and simple corner adjustment of several load cells.

K

KCP

KCP is an universal communication protocol between laboratory balances, industrial scales or other measuring instruments and digital devices, such as a computer, server or process management system. Due to the universal protocol structure, one measuring instrument can be replaced by another without adapting the communication interface.

L

Linearity/Precision

Greatest deviation of the weight displayed of a balance with regard to the value of the respective test weight in terms of plus and minus across the whole weighing range.

M

Minimum load [Min]

Lower limit of the verifiable weighing range. Is marked on the verification mark. The function of the balance is also given below the minimum load.

Minimum sample weight

Indicates the smallest weight which can be determined, depending on the process accuracy required.

Multi-division balance / Multi-range balance

On multi-division balances, the weighing range is subdivided several times, each with a different readability. The readability [d] changes automatically with increasing and decreasing load. Multi-range balances have several weighing ranges with different maximum loads and different numerical increments. Switching takes effect automatically when the load increases; switching back to the lower weighing range only takes effect when the scale has been completely unloaded.

N

Newton

Newton (N) is the unit for physical force values. A Newton is the force required to accelerate a 1 kg mass at rest to a speed of 1 m/s within one second.

Notified body

Neutral and independent, predominantly government bodies, which are formally appointed by the EC. They are engaged in the field of verification for conformity evaluations (initial verification) and type-approval test within the scope of type approvals.

O

Optimisation of reference weight (when piece counting)

See product group 9 "Counting balances/ Counting systems".

P

Percentage determination



Example: Reference weight prior to drying: 50g = balance display 100%. After drying 40g = balance display 80% absolute (dry mass) or 20% relative (humidity).

Permissible ambient temperature

Measuring errors are possible if you use the balances outside the permitted specified ambient temperature range. With verified balances this is stated on the identification plate.

PLU (Price Look Up)

This refers to a data memory in price-computing retail scales for the base price of sales items.

Pre-packaging legislation (FPVO)

Ensures that pre-packed goods are filled correctly, for example, in food industry. The Weights and Measures Act governs the permissible weight and volume tolerances.

PRE-TARE

Entering and saving a tare weight (e.g. container weight) through weighing or manual entry using the balance keypad before the actual weighing process. When you subsequently place the tare container on the balance, the balance will show zero immediately – saves time. Particularly useful e.g. for checking fill levels

Proof of compatibility

This documents the verification compatibility for combinations of weighing modules such as display devices, load cells and connecting elements.

R**Readout [d]**

Smallest readable weight increment on a digital display.

Recalibration

Periodic checking of the precision of measurement equipment/checking equipment (e.g. balances/weights) to control accuracy, ► **Control of measurement equipment**

Reference weight (when piece counting)

See product group 9 “Counting balances/Counting systems”.

Reproducibility (standard deviation)

Sequenced measure of conformity in repeated weighing (e.g. balances) subject to the same conditions. Mostly 1 [d] or less. Quality feature.

Resolution of a balance

The resolution is calculated from the weighing range [Max] divided by the readout [d], e.g. [Max] 420 g : [d] 0.001 g = 420,000 points. The resolution is a quality feature – the higher, the better.

S**SC-TECH = Single-Cell-Technology**

► **FORCE**. The load cell consists of a single aluminium block, which gives a very high measurement quality.

Semi-micro balance

Analytical balance with a readout [d] = 0,01 mg

Smallest part weight when counting

The smallest piece weight, which a balance can accept for piece counting. For the relevant model, enter “g/piece” in the product data table.

T**T-FORK = Tuning fork principle**

A resonating body (like a tuning fork) is electromagnetically excited, causing it to oscillate. The measured value is calculated via the change in frequency corresponding to the load of the weight being measured on the scale.

Taring, automatic

► **PRE-TARE**

Taring, subtractive

The available weighing range of a balance is reduced by the value of the tare load. Example: weighing range of a balance Max 6000g, Tare (= container) 470g, available weighing range 5530g.

Test weight, external (previously calibration weight)

For adjusting or checking the balance accuracy ► **Adjusting the weighing range**. The external test weight can be DAKkS calibrated at any time, even afterwards, see product group 18 “Calibration Service”.

Test weight, internal

Like test weight external, but installed in the balance and powered.

Totalising

Various individual weighings are added automatically to aggregate, e.g. all individual weighings of a batch.

Traceability to the National Standard

A pre-requisite for every perfect measurement is the validated comprehensive proof that the measuring equipment can be traced back to the international or national standards. In Germany the statutory binding standards are available from the PTB.

Type approval for balances

Strict process to test whether a balance fulfils the verification requirements. A balance can only be verified, if it has got a type approval from a ► **notified body**.

U**Uncertainty of measurement of a balance (= standard deviation)**

Determined for each balance according to a precisely given test method and documented in the ► **Calibration certificate**. It depends on various factors, both, internal and external. Uncertainty of measurement increases by a rising charge of the balance, see product group 18 “Calibration Service”

V**Verification**

Verification, in accordance with the new terminology “Conformity assessment”. Only balances with ► **EC type approval** can be evaluated for conformity. These balances have an identification plate with the metrology marking **M**. The state requires assessment for conformity and this assessment serves as consumer protection. According to EU directive 2014/31/EEC balances must be officially assessed for conformity (calibrated) if they are used as follows:

- in commercial trade when the price of a commodity is determined by weighing.
- in the manufacture of pharmaceuticals in pharmacies and analysis in pharmaceutical and medical laboratories.
- for official purposes.
- in the production of prepackaging.
- in medical applications.

Every balance is tested by KERN and marked with a conformity mark. Its accuracy within the framework of permissible tolerances is thereby confirmed. EU verification applies to all member states of the EU.

Verification classes of balances

Class I – Analytical balance (precision balance), Class II – precision balance, Class III – industrial scale (commercial scale).

Verification of a balance with adjusting program CAL EXT

The adjusting program is sealed with an official mark after the verification. Thus the verification is only valid for the specific location of use.

► Gravitational force

To be able to correctly adjust the balance to your location of use, it is necessary to advise the location of use and postcode. See individual model details for the information as to whether verification can be carried out in the factory or at the location of use.

Verification of a balance with automatic internal adjusting CAL INT

The above restrictions in respect of the location of use do not apply, because the automatic internal adjusting works also after verification, therefore it is not sealed. In this case, verification does not depend on the location.

Verification validity for balances

Generally 2 years for all verification classes, for control balances generally 1 year, after expiry the balance has to be re-verified.

Verification value [e]

Measure of the verification tolerance, depending on balance, mostly between 1 [d] and 10 [d] ► **Readout**

W**Weighing range [Max]**

is the working range of the balance. The balance can be loaded up to the specified upper limit.

Sales conditions



All prices are valid as of January 1st 2023,

Subject to change without notice. Current prices at www.kern-sohn.com. In Europe, all prices do not include the applicable V.A.T.

Delivery Conditions: we supply ex works Balingen, e.g. the transport costs are invoiced. With our contract logistics partners we always offer you shipping at a good rate. When shipping to islands or other more distant areas, or areas which are difficult to access, the transport costs may possibly be higher, please ask for details. Any goods supplied remain KERN's property until complete payment for the goods sold has been received.



Delivery is usually via courier service.



When you see this symbol by truck, please ask for prices.

Extract from general terms and conditions:

Court of jurisdiction/Legal domicile:

72336 Balingen, Germany;

Commercial register N°: HRB 400865, AG Stuttgart;

Managing director: Albert Sauter

For the full Terms and Conditions, please refer to the website.

www.kern-sohn.com/en/kern/agbs.html

Price changes and product changes are likely in individual cases, due to product modifications as well as error.

Sale or return: within 14 days of purchase. Not valid for order-specific adaptations such as special productions, cable extensions, special weights, etc. or test services such as calibration, verification, etc. Depending on the time and effort involved, there may be processing and storage costs, please ask for details.

Warranty:

- 3 years for products with list price \geq € 500.00
 - 2 years for components as well as products with list price $<$ € 500.00
 - 1 year for pallet truck scales
- Does not apply to consumables such as batteries, rechargeable battery packs, etc.

Balances in areas regulated by law (► Verification) must comply with the commercial error limits during the period of validity for verification – these are usually double the verification permissible error limits. If this period of validity for verification expires, then reverification must be carried out. If, in order to pass the verification, it should be necessary to adjust the balance to comply with the verification permissible error limits, then this does not constitute a warranty claim.

Service



KERN DirectCash: The quick, secure COD procedure for protection against non-payment. With the KERN DirectCash COD system, you can safely deliver orders to end customers with unknown credit rating, with no risk of non-payment. Please request further details on this procedure.

Hire Purchase

Financing is available using KERN hire purchase – easy and convenient. Hire Purchase gives you the option of purchasing any product from our range against a simple monthly installment. The product value is financed over the period of the agreement. On payment of the last installment, the ownership of the contract item automatically transfers from the contractor to the contractee. The Hire Purchase Agreement can – if you so choose – be set for a period of between one and five years. This package includes the transfer of items as well as the guarantee for the entire transfer period.

Compared with buying the product, KERN hire purchase offers the advantage that the initial financial investment is largely unnecessary. This is particularly relevant when purchasing a number of products, for example when refitting a laboratory, a company department or a hospital ward. In addition the monthly installments constitute a direct cost and the item does not have to be capitalised by the purchaser.

After-Sales-Service



Repair service

Within 1 week at our plant in Balingen, transportation costs are additional. In urgent cases, if requested by customer, a replacement device will be provided until all repairs are completed; please ask.

Price reduction for a new device

If repair costs exceed the current value of the defective device, a new device will be offered for a discount price. This offer is valid only up to 2 years after warranty expiration.

Spare parts service

Usually within 48 hours, transportation costs are additional.

Marketing support



KERN catalogues, brochures, branch prospectuses – your own personalised marketing tools

This catalogue and branch prospectuses are available free of charge. A neutral version of the catalogue, without the KERN address imprint, is also available free of charge for your marketing activities, larger quantities on request.

On demand, your company logo and address can be printed on the back of the KERN catalogue free of charge, larger quantities on request. In this way you have got your own individual marketing tool.

The KERN catalogue and branch prospectuses are available in the following languages: DE, EN, FR, IT, ES.

For further details, see page 2.

Important notice



Explosion hazard or humidity

Our balances are not suitable for rooms with a risk of explosion. Our models are also not suitable for rooms with a high level of air humidity (condensing). Please observe the applicable electrical regulations.

Earth's gravitational force

Electronic balances are subject to location regulations due to the earth's gravitational force. If location of use is changed, reverification and recalibration of the electronic balance is needed.

See the glossary, page 223 ► **Adjusting**